

AUTOMATIC LUBRICATION EQUIPMENT

Buyer's Guide



M O V I N G M A T E R I A L S T H A T M A T T E R ™



TABLE OF CONTENTS

	Page
About Graco	4-6
Graco Resources	6
Mobile Equipment Kits	
Yellow Iron Selector Tool	7
Pumps	
Graco Buyer's Guidance: Pump Selection	9-10
Electric Pumps	
Electric Pump Selection Guide	11-12
G-Mini® Compact Pumps	13-14
G-Mini® / CSP Valve Kits	15
G3® Pumps	16-23
G-Series Pump Packages and Accessories	24-30
G3® HF Pump	31-32
G3® Hammer Pump	33-34
G3® Dual-Line Pump	35-36
G5™ Pumps	37-41
Lube Master®	42-45
Miniature Meter-Flo®	46-47
Meter-Flo®	48-49
Compact Dyna-Star®	50-51
GLC™ X Controller and Auto Lube™ App	51
Electric Dyna-Star® HP and Dyna-Star HF	52-55
Electric Dyna-Star® XT	56
Manzel® MBL Box Lubricators	57-61
Pneumatic Pumps	
Pneumatic Pump Selection Guide	62
LubePro™	63-67
LubriSystem	68-69
Modu-Flo®	70-74
E-Series	75-76
MSA-10 and MSA-100	77-78
Pneumatic Dyna-Star® Fire-Ball® 300 50:1	79-80
Hydraulic Pumps	
Hydraulic Pump Selection Guide	81
Modu-Flo®	82
Hydraulic Dyna-Star®	83-86
Mechanical Pumps	
Mechanical Pump Selection Guide	87
Lube Master® Ratchet Drive	88-90
Manzel® MBL Box Lubricators	91-94
Manual Pumps	
Manual Pump Selection Guide	95
PH Pump	96-97
LubriSystem	98
Controllers	
Controller Selection Guide	100-101
GLC™ X Controller and Auto Lube™ App	102-103
GLC™ 4400 Controller	104
GLC™ 2200 Controller	105-106
Grease Jockey® Timer	107-108
Solid State Timer	109
Controller Accessories	110-111

Metering

How to Design a Metering Device System	114
Metering Device Selection Guide	115
Thrif-T Luber®	116
Piston Distributors	117
GL-32™, GL-43™, GL-33™ and GL-42™ Injectors	118-120
GCI Injectors	121-122
GL-1™ Injectors	123-125
GL-11 Injectors	126
Compact Series Progressive (CSP) Valves	127-128
Trabon® MD Mono-Block Divider Valve	129
Trabon MJ Divider Valve	130-133
Trabon MSP Divider Valve	134-140
Trabon MSP Stainless Steel Divider Valve	141-146
Manzel® MHH Divider Valve	147-151
Trabon MX Divider Valve	152-155
Trabon MXP Divider Valve	156-160
Trabon MGO Divider Valve	161-164
Proximity Switches	165-166
Air Oil Manifold	167

Accessories

Lubricant Spray	169
Zone Valves	170
Reset Indicators	171
Automatic Relief Indicator	172
Rupture Indicator	173
Rupture to Atmosphere Indicator	174
Magnetic Visual Indicator	175
Broken Line Indicator	176
Filters	177-178
Brushes	178
Installation Accessories	
Straight and Angle Swivels	179-180
Steel Fittings	181-186
Steel Swivel Adapters	187-188
Steel JIC Fittings	189-194
Stainless Steel Fittings	195-196
Stainless Steel Swivel Adapters	197
Stainless Steel JIC Fittings	198-200
Check Valves	201-206
Pressure Sensors	207
Pressure Gauges	208
Other Fittings and Accessories	209-210
Hoses, Tubing and Fittings	211-223

Manzel Systems

MBL Box Lubricators	226-230
MB Specialty Box Lubricators	231
GBL 7500 Pump	232
Model HP-15™ High Pressure Lubricators	233
Model HP-50™ High Pressure Lubricators	234
MVB Pump	235
MVB Box Lubricator Configurator	236
Lube-Line Alert	237
Pneumatic/Electric Lube Sentry Valve	238
Balancing Valve	239

On-Road Lubrication

Electric Grease Jockey®	241-243
Electric Grease Jockey Manifolds	244
Electric Grease Jockey Injectors	245
Electric Grease Jockey Accessories	246-249
Pneumatic Grease Jockey	250-252

Warranty Information	253-255
-----------------------------------	---------

Index	256-267
--------------------	---------

ABOUT GRACO

100 YEARS OF MOVING MATERIALS THAT MATTER – TOGETHER

For a century, Graco has partnered with customers to solve complex challenges and deliver trusted solutions. From the first air-powered grease gun to today's smart, sustainable systems, our commitment to innovation and quality has never wavered. This centennial marks a legacy of collaboration, reliability, and progress. As your needs evolve, so do we – investing in technology, expanding our capabilities and staying focused on what matters most: helping you succeed.

Thank you for being part of our journey. The next 100 years start now – and we're honored to move forward with you.



A History of Innovative Lubrication Solutions

The Gray brothers launched Graco to manufacture and market an air-powered, portable lubricator invented by Russell Gray while he was working as a parking lot attendant. The idea emerged as he struggled with a manual grease gun in freezing Minneapolis temperatures that turned grease into thick sludge. Over time, growing demand for lubrication equipment pushed the brothers to develop larger, specialized lubricators. Graco soon became a leader in the lubrication equipment industry.





Today, Graco manufactures equipment to monitor, control, manage and dispense fluids, providing innovative solutions for vehicle service, industrial and automatic lubrication needs. Our commitment is to keep your equipment running at peak performance.

Graco automatic lubrication solutions deliver optimal machine performance by lubricating key wear points with the right amount of lubricant, at the right time and in the right location. Graco offers automatic lubrication solutions for industrial, on-road mobile, off-road mobile and energy applications, among others. From light-duty uses to high-performance systems designed for heavy-duty jobs, Graco equipment is known for rugged, durable, long-life design.

Whether servicing vehicles, operating heavy equipment, performing maintenance repairs, working on an oil rig or running manufacturing lines, customers rely on Graco as a trusted source to help maximize profitability every time.

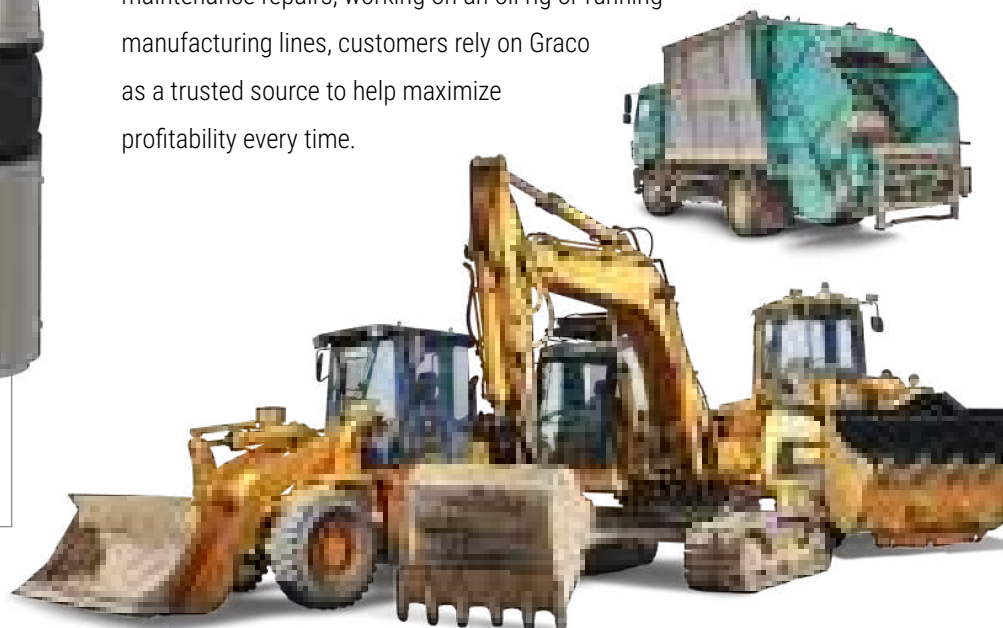

DID YOU KNOW?

Graco also manufactures and sells a complete line of high-quality pumps, meters, valves and hose reels!



Graco offers a full line of quality equipment to meet the varying needs of vehicle maintenance and repair. Streamline your workflow and move more lubricants through your shop. We offer reliable, high-quality equipment you can depend on for fuel, diesel, antifreeze, oil and grease. Our versatile fluid inventory control and management systems are designed to accurately track the use of oil, grease and other automotive fluids at vehicle maintenance facilities, and our lubrication equipment ensures you deliver fluids to the right spot in your shop.

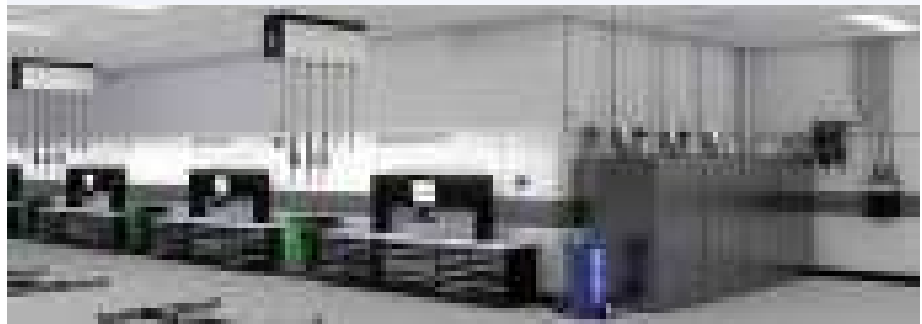

Visit www.graco.com/vehicle-service

Graco Resources

Graco has developed tools and resources to help educate and better serve our distribution channel. Check them out today:



Graco Sales Book

Stay up-to-date with the newest information from Graco by downloading the Graco Sales Book App.

Graco Sales Book is an innovative mobile application, designed to give Distributors access to Graco product information, including brochures, instruction manuals, videos and training documents – all on your mobile device.

Download today by visiting salesbook.graco.com

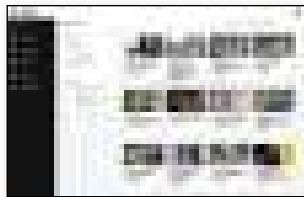

Graco University

Graco University is an e-learning module that can be accessed online, anytime, and contains assets that help educate you on Graco products.

This innovative online learning program gives the tools to stay on the leading edge with a variety of resources such as virtual and instructor led courses, online books, live and on-demand video presentations, and much more.

Learn more today at training.graco.com



Graco Gear

Graco Gear is your one-stop shop for branded merchandise and other tools that will help you build customer relationships.

Order shirts, hats, banners, and more whenever you need! You can even add your logo for a small fee. Most orders ship next day.

Start shopping today at gracogear.com



MOBILE EQUIPMENT KITS



Graco mobile equipment kits provide the latest technology from Graco, including the G-Series pumps, solid-state proximity switches, CSP divider valves, and hoses and fittings. Each kit will include all of the components necessary for model-specific customizations.

In order to eliminate system design and streamline the sales process, we have created a quick-to-spec, quick-to-quote and quick-to-sell solution. Scan the QR code below or visit www.graco.com/offroadselector to find an automatic lubrication kit for your piece of heavy equipment.



MOBILE EQUIPMENT KITS

PUMPS

	Page
Graco Buyer's Guidance: Pump Selection	9-10
Electric Pumps	
Electric Pump Selection Guide	11-12
G-Mini® Compact Pumps	13-14
G-Mini®/CSP Valve Kits	15
G3® Pumps	16-23
G-Series Pump Packages and Accessories ..	24-30
G3® HF Pump	31-32
G3® Hammer Pump	33-34
G3® Dual-Line Pump	35-36
G5™ Pumps	37-41
Lube Master®	42-45
Miniature Meter-Flo®	46-47
Meter-Flo®	48-49
Compact Dyna-Star®	50-51
GLC™ X Controller and Auto Lube™ App	51
Electric Dyna-Star® HP and Dyna-Star HF ..	52-55
Electric Dyna-Star® XT	56
Manzel® MBL Box Lubricators	57-61
Pneumatic Pumps	
Pneumatic Pump Selection Guide	62
LubePro™	63-67
LubriSystem	68-69
Modu-Flo®	70-74
E-Series	75-76
MSA-10 and MSA-100	77-78
Pneumatic Dyna-Star® Fire-Ball® 300 50:1 ..	79-80
Hydraulic Pumps	
Hydraulic Pump Selection Guide	81
Modu-Flo®	82
Hydraulic Dyna-Star®	83-86
Mechanical Pumps	
Mechanical Pump Selection Guide	87
Lube Master® Ratchet Drive	88-90
Manzel® MBL Box Lubricators	91-94
Manual Pumps	
Manual Pump Selection Guide	95
PH Pump	96-97
LubriSystem	98



GRACO BUYER'S GUIDANCE: PUMP SELECTION



WHEN DETERMINING THE RIGHT GRACO PUMP FOR YOUR APPLICATION, PLEASE CONSIDER THE FOLLOWING FACTORS:

1. What POWER is available?

Graco has pump options for:

- Electric
- Pneumatic
- Hydraulic
- Mechanical
- Manually operated



If the customer has multiple power options available, which one would they prefer to use?

2. What FLUID is being used as the lubricant?

Is this an oil system or a grease system?

- Several pumps work with both oil and grease, but many are for one or the other.
- **Important:** Graco automatic lubrication equipment is designed for use with oils and greases that are based on mineral oil or synthetic lubricant. If you are working with a different material, please contact the correct Graco division.

3. Which type of METERING DEVICE is being used?

Single Line Parallel (SLP) systems require a vent valve to function.

- Injectors and piston distributors (Injecto-Flo) are SLP systems.
- Not all pumps are offered with vent valves.
- Some vent valves are sold separately.
- Some do not offer a vent valve option.

Series Progressive Divider Valve (SPDV) and Single Line Resistive (SLR) systems require a relief valve, but not a vent valve.



4. What FLUID PRESSURE and FLOW RATE are needed to operate the metering system?

Pressure at the pump outlet is affected by the type and size of the metering system, as well as the viscosity and temperature of the lubricant.

- With SPDV and SLR, total flow is simply the sum of all the lube points' flow requirements.
- For Injectors and other SLP systems, extra volume is required because some of it is vented back to the reservoir between lubrication cycles.

For more information on lubricant metering options, see the Metering Devices section later in this Buyer's Guide.

GRACO BUYER'S GUIDANCE: PUMP SELECTION

5. What SIZE OF RESERVOIR is required?

System design “best practice” is to deplete the reservoir once a month, if possible.

- This keeps the customer from forgetting that it needs to be refilled regularly.
- Regular reservoir depletion also helps to prevent grease separation.

6. Does the customer prefer to have a CONTROLLER INTEGRATED into the pump body?

Integrated controllers are only offered on G-Series pumps:

- G3, Pro and Max
- G5 Pro
- G-Mini Controller
- Electric Grease Jockey (EGJ)

Most G-Series pumps also offer a controller-less version for use with external controllers or a customer's PLC.

- G3 Standard
- G-Mini No Controller

Some pumps are designed to run constantly, without a controller. All other pumps require an external controller, which can be:

- a Graco controller
- a different brand
- a PLC
- or anything that can control the pump's connection to its power source.

For more information on controller options, see the Controllers section later in this Buyer's Guide.

7. Other factors to consider:

- Does the pump need to send some form of signal output (i.e. alarm, low level, etc.)?
- Does the pump need to log performance data (i.e. DMS or Auto Lube app)?
- Is the pump mounted in a location that would benefit from Auto-Fill Shut Off (AFSO)?
- What are the operating conditions of the application (i.e. weather, heat, vibration, contamination, etc.)?

Important: Always keep in mind that there could be more than one correct answer.

- Don't be surprised if you have more than one good option.
- Ultimately the choice may come down to preference; either yours or your customer's.





**Consult with your local Graco Lubrication Account Manager
for help finding the best solution.**



ELECTRIC PUMP SELECTION GUIDE

Pump Family	Typical Applications	Voltage	Fluid Type	Maximum Output Pressure psi (bar)	Maximum Output Volume per Minute in³ (cm³)	Reservoir Capacity Options		Metering	Reference Page
						US	Metric – Liters		
G-Mini® 	<ul style="list-style-type: none"> Energy, Infrastructure and Heavy Equipment In-Plant Manufacturing Vehicle Service 	12 or 24 VDC	Grease up to NLGI #2	4,061 (280)	0.18 (3)	1 or 2 lb	0.5, 1 or 2	SPDV	13-15
G3® 	<ul style="list-style-type: none"> Energy, Infrastructure and Heavy Equipment In-Plant Manufacturing Vehicle Service 	12 or 24 VDC, 90-240 VAC, 50/60 Hz	Oil – 40 cSt minimum Grease – up to NLGI #2	5,100 (352)	0.25 (4) per element. Up to 3 pump elements.	4, 8, 16, 24 or 32 pint/lb	2, 4, 8, 12 or 16	SPDV or SLP	16-30
G3® HF Pumps 	<ul style="list-style-type: none"> Energy, Infrastructure and Heavy Equipment In-Plant Manufacturing 	24 VDC (18-30 VDC; 3.2 amp current (4 amp with vent valve), inrush/locked rotor 30 amp)	Grease up to NLGI #2	3,500 (241)	1.5 (24.6)	8, 16 or 24 lbs	4, 8 or 12 liter	SLP	31-32
G3® Hammer Pumps 	<ul style="list-style-type: none"> Hydraulic breakers/hammers 	18-30 VDC; 2.5A current, 60W, inrush/locked rotor 6A	Chisel paste, NLGI #000 to #2 greases	5,100 (352)	0.25 (4) per element	8 or 16 lb	4 or 8	SPDV or SLP	33-34
G3® Dual-Line 	<ul style="list-style-type: none"> Construction equipment Mining equipment Agricultural equipment 	18-30 VDC	NLGI #000 to #2 greases	3,500 (241)	0.25 (4) per element. Up to 3 pump elements.	8 or 16 lb	4 or 8	SPDV or SLP	35-36
G5™ 	<ul style="list-style-type: none"> Quintuplex frac pumps Pumpjacks Other pump-to-point applications 	24 VDC	Packing lube	4,250 psi (293)	0.155 (2.54) per element	8 or 16 lb	4 or 8	PtP	37-41
Lube Master® 	<ul style="list-style-type: none"> In-Plant Manufacturing 	115/230 VAC, 1 phase or 230/460 VAC, 3 phase 60 Hz	Oil/grease up to NLGI #2	5,000 (345)	8.6 (143)	Oil – 12 or 20 pint Grease* – 6 or 12 lb	Oil – 5.5 or 9 Grease – 3 or 6	SPDV	42-45

*See page 73 for note on legacy Trabon grease reservoir volumes and metric conversions.

 = Single Line Parallel (Injectors)
  = Series Progressive Divider Valve
  = Single Line Resistive
  = Pump to Point

ELECTRIC PUMP SELECTION GUIDE

Pump Family	Typical Applications	Voltage	Fluid Type	Maximum Output Pressure psi (bar)	Maximum Output Volume per Minute in³ (cm³)	Reservoir Capacity Options		Metering	Reference Page
						US	Metric - Liters		
Miniature Meter-Flo® 	• In-Plant Manufacturing	115 VAC, 60 Hz, 1 phase or 230 VAC, 50/60 Hz, 3 phase	Oil – 160 to 15,000 SUS	2,000 (138)	14 (229)	1.5, 3 or 5 gallon (12, 24 or 40 pint)	5.7, 11 or 19	SPDV or SLR	46-47
Meter-Flo® 	• In-Plant Manufacturing	Motor sold separately	Oil – 300 to 3,000 SUS	1,500 (103)	245 (4,015)	N/A	N/A	SPDV	48-49
Electric Grease Jockey® 	• Vehicle Service	12 or 24 VDC	Grease up to NLGI #2	2,000 (352)	0.5 (8) per element. Up to 3 pump elements.	4 lb	2	SLP	241-249
Compact Dyna-Star® 	• Energy, Infrastructure and Heavy Equipment • In-Plant Manufacturing • Vehicle Service	24 VDC 90-240 VAC, 1 phase, 50/60 Hz*	Oil/grease up to NLGI #2	3,500 (241)	4.5 (74)	24, 48 or 60 lb reservoir or 35 lb pail option	12, 20 or 30 L reservoir or 20 L pail option	SPDV or SLP	50-51
Electric Dyna-Star® 	• Energy, Infrastructure and Heavy Equipment • In-Plant Manufacturing	24 VDC 90-240 VAC, 1 phase, 50/60 Hz*	Oil/grease up to NLGI #2	5,000 (344)	35 (574) adjustable	60 or 90 lb reservoir	30 or 45 L reservoir or standard barrel length options	SPDV or SLP	52-55
Dyna-Star® XT 	• Energy, Infrastructure and Heavy Equipment • In-Plant Manufacturing	100-120 V, Single Phase, 50/60 Hz, 12 A	Grease up to NLGI #2	7,000 (483)	63 (1,032) adjustable	400 lb barrel length		SPDV or SLP	56
Manzel® MBL 	• In-Plant Manufacturing	115/230 VAC, 1 phase or 230/460 VAC, 3 phase, 60 Hz	Oil – 80 to 5,000 SUS	7,500 (517)	2.7 (44) per element, adjustable. Up to 24 pump elements.	4, 6, 8, 12, 16, 24, 32 or 40 pint	1.9, 2.8, 3.8, 5.7, 7.6, 11, 15 or 19	SPDV or PtP	57-61

*CDS and EDS pumps require converter box 77X524 for AC applications.



= Single Line Parallel (Injectors)



= Series Progressive Divider Valve



= Single Line Resistive



= Pump to Point



G-MINI[®] COMPACT PUMPS

SMALL SIZE. BIG VALUE. HUGE IMPACT.

Make the most of your space, budget and machines. The new full-featured G-Mini offers reliable lubrication in a small footprint to fit more types of machines. Use it to simplify everyday maintenance, extend life cycles and optimize uptime. It's rugged and tough, perfect for handling the 24/7 rigors of any job, big or small. Best of all, it comes with a modest price tag – boosting your productivity and profitability.



Rugged Construction

Designed to withstand the harshest of environments; IP69K rated.

Multiple Reservoir Options

0.5 liter, 1 liter and 2 liter grease capacity.

Follower Plate and Stir Paddle

Available in 0.5 liter and 1 liter reservoirs.

Up to Two Pump Elements

- 0.18 in³/min (3 cm³/min)
- 4,061 psi (280 bar)

M12 Input

M12 cycle or proximity switch input standard on all pumps with a controller.

Patent-Pending Heater Option

Built-in heater option automatically turns on at 23°F (-5°C), allowing NLGI #2 grease to pump down to -40°F (-40°C).

Power and Low Level Options

CPC or DIN-style connectors make for easy, no hassle installations.

Optional Controller

- **No Controller:** Pair with either an external controller or a PLC.
- **Controller:** Easy-to-program controller can be utilized for both time-based and cycle-based systems and provides low-level alert and alarm.

TYPICAL APPLICATIONS

- Wind energy
- Industrial
- Off-road mobile equipment
- On-road mobile equipment

TECHNICAL SPECIFICATIONS

Maximum Working Pressure	4,061 psi (280 bar)
Fluids Handled	Grease NLGI #000 to #2, Oils 40 cSt and up
System	Pump to point or series progressive
Power	12 VDC, 24 VDC or 100-240 VAC
Operating Temperature	-40°F to 158°F (-40°C to 70°C)
Reservoir Size	0.5, 1 or 2 liter
Pump Element Output	0.18 in ³ (3 cm) per minute
Pump Elements	Up to 2
Pump Outlet Thread	1/4-18 NPSF female, mates with 1/4-18 NPT male fittings
Certifications/Ratings	CE, ETL*, IP69K *Conforms to UL 73, certified to CSA 22.2 No. 68-09
Instruction Manual	3A6714

G-MINI® COMPACT PUMPS

ORDERING OPTIONS

G-MINI GREASE PUMPS

Controller Option	Voltage	With Follower Plate		With Follower Plate and Heater	Without Follower Plate	
		0.5 L	1 L	1 L	1 L	2 L
No Controller	12V CPC	-	25R802	-	-	25R832
	24V CPC	25R807	25R800	-	-	25R831
	24V DIN	-	25R820	-	-	25R835
	AC DIN	2000643	2000645	-	2000648	2000650
Controller	12V CPC	-	25R803	-	-	25R834
	24V CPC	-	25R801	25R804	-	25R833
	24V DIN	-	25R821	25R824	-	25R837
	AC DIN	2000644	2000646	2000647	2000649	2000651

G-MINI OIL PUMPS

Controller Option	Voltage	1 L	2 L
No Controller	24V DIN	2000634	2000638
	AC DIN	2000635	2000639
Controller	24V DIN	2000636	2000640
	AC DIN	2000637	2000641

ACCESSORIES

Part Number	Description
127783*	2-wire CPC power cable, 15 ft (4.6 m)
2003467*	5-wire CPC power cable, 15 ft (4.6 m)
2007482*	DIN connector power or low level cable
25C981	12V manual run button (5-wire CPC power cable required)
25C982	24V manual run button (5-wire CPC power cable required)
26C825	Direct mount CSP bracket (allows for drop-in replacement of competition)
26C826	Universal mounting bracket (allows for drop-in replacement of competition)
17L879	Graco CSP solid state proximity switch (DC PNP)
17R703	1 ft proximity switch cable, M12 female straight to M12 male straight cable
124333	16.5 ft proximity switch cable, M12 female straight to M12 male straight
26A910	4,000 PSI pressure relief kit (1/4 NPT to 1/8 NPT reducer bushing, 1/8 NPT tee-fitting, 4,000 PSI pressure relief valve)
26C947	Pump element kit (add a second pump element or replace existing)
24M644	High capacity fill stud with dust cover. Installs in 1/4 in NPT port on either side of pump base. For applications requiring a 90 degree elbow, add p/n 15M045.
121474	Mating coupler for 24M644 fill stud
247886	Manual fill pump – fits 5 gallon or 35 lb pail, includes 121474 (requires 24M644)
2000200	Cartridge filler pump adaptor with M20 thread, installs in unused pump socket. For use with 2006597 fill pump.
2006597	Cartridge filler pump – for use with 14 oz (400 g) grease cartridges. Requires adapter 2000200.



25R802



25R803

*G-Mini pumps do not come with power cables. Power cables needed for installation.

See the G-Series Pump Accessories section (pages 24-30) for additional G-Mini accessories.



G-MINI® PUMP/CSP VALVE KITS

G-MINI/CSP VALVE KITS

Each kit includes a controller pump with 1 liter reservoir with follower plate (25R821 or 2000646), mounting bracket, pressure relief valve and outlet hose all pre-assembled to the pump. These kits allow users to quickly build a simple automatic grease system for many small applications. All pumps below include a controller and utilize DIN connections for their power cables.

Also included:

(Parts in this bulleted list are shipped loose, to be installed in the field.)

- G-Mini power cord
- CSP valve
- CSP outlet fittings for 6 mm OD tubing
- 6 mm x 1/8 in NPT end point fittings
- Elbow fitting for the CSP inlet
- 6, 8 and 10 outlet kits include 82 ft (25 m) of 6 mm OD tubing
- 12, 14 and 16 outlet kits include 164 ft (50 m) of 6 mm OD tubing

ORDERING OPTIONS

24 VDC PACKAGES

Kit Part Number	Number of Outlets	24VDC Pump Assembly Part Number	CSP Valve Part Number	Outlet Fitting Quantity
2000534	6	2000047	24Z486	6
2000535	8		24Z487	8
2000536	10		24Z488	10
2000537	12		24Z489	12
2000538	14		24Z490	14
2000539	16		24Z491	16

115/230 VAC PACKAGES

Kit Part Number	Number of Outlets	AC Pump Assembly Part Number	CSP Valve Part Number	Outlet Fitting Quantity
2004439	6	2004436	24Z486	6
2004441	8		24Z487	8
2004443	10		24Z488	10
2004445	12		24Z489	12
2004446	14		24Z490	14
2004447	16		24Z491	16

G3[®] PUMPS

VERSATILE DESIGN HELPS SOLVE TODAY'S LUBRICATION CHALLENGES

Temperature changes, changing grease types and challenging installation requirements are no problem for the G3 electric lubrication pump. With its flexible design, including five reservoir sizes, three controller options, three power types and an adjustable pump element, the G3 is a rugged, cost-effective pump designed to serve multiple markets and applications.

Reservoir Types

Stirring paddle with wiper arm to keep material from separating. Follower plate available for extreme angle installations. Spin-off lid option allows easy grease removal for servicing. Auto-Fill Shutoff (AFSO) option simplifies remote filling. Oil reservoirs include vented fill cap and strainer.

Multiple Reservoir Sizes

Choice of 2, 4, 8, 12 or 16 liter U.V. resistant, high-impact reservoirs for oil and grease to meet the needs of your equipment.

Cycle Switch Input

Count cycles of a series progressive divider valve such as MSP, CSP and others.

Three Pump Elements

G3 comes standard with one adjustable pump element installed – add up to two more for higher output on large projects.

Power Choices

Connect to DC (12 or 24V) and AC (90-240V) power sources with CPC or DIN-style connectors for easy, no hassle installations.

Versatile Pressure Sensor Input

Compatible with analog pressure transducers. Also works with PNP, NPN and dry contact pressure switches.

Machine Count Input

Machine count input to manage equipment with unpredictable lubrication requirements.

Controller Options

Choose from Standard, Pro and Max controller options – buy only what you need for your application.

Vent Valve Output

Combine Max controller with a vent valve for injector-based systems.



TYPICAL APPLICATIONS

- Off-road mobile equipment
- On-road mobile equipment
- In-plant machine and conveyor lubrication
- Wind energy

TYPICAL FLUIDS

- Oil
- Grease up to NLGI #2

TECHNICAL SPECIFICATIONS

Maximum Working Pressure	5,100 psi (352 bar)
Fluids Handled	Grease NLGI #000 to #2, Oils 40 cSt and up
Power	12 VDC, 24 VDC or 100-240 VAC
Operating Temperature	-40 to 158° F (-40 to 70° C) depending on lubricant used
Reservoir Size	2, 4, 8, 12 or 16 liter
Pump Element Output	0.12 in ³ , 0.18 in ³ or 0.25 in ³ (2 cm ³ , 3 cm ³ or 4 cm ³) per minute
Pump Elements	Up to 3
Pump Outlet Thread	1/4-18 NPSF female, mates with 1/4-18 NPT male fittings
Certifications/Ratings	CE, ETL*, IP69K *Conforms to UL 73, certified to CSA 22.2 No. 68-09
Instruction Manuals	Standard – 332291 / Pro – 332298 / Max – 3A9511



G3 STANDARD, PRO AND MAX GEN 2

Choose the level of control you need for your series progressive or injector based applications.

G3 STANDARD

- No internal controller – use with separate or existing machine control for a low cost solution
- Capable of sending a low level signal to your external controller or PLC



G3 PRO

- Built-in controller with selectable pump on/pump off timer
- Low level indicator provides low warning and shut-down alarm
- Manual run initiates lube cycle on-demand (remote option also available)
- Password protection safeguards settings
- Pre-lube function can initiate lube cycle on start-up



AUTO-FILL SHUT OFF (AFSO)

- Available on G3 Standard, Pro and Max
- Eliminates over- or under-filling
- Completely fill the reservoir while avoiding costly spills
- Does not require power to operate

G3 MAX GEN 2

- Built-in controller with option of ending on time, cycle or pressure
- Low level indicator provides low warning and shut-down alarm
- Manual run initiates lube cycle on-demand (remote option also available)
- Password protection safeguards
- Pre-lube function can initiate lube cycle on start-up
- Machine count input – ideally suited for inconsistently used equipment
- Fault indication to external alarms
- Cellular data option gives access to pump status and programming from virtually anywhere



G3® PUMPS

ORDERING OPTIONS



G3 STANDARD

Comes standard with no controller for use with separate or existing machine control for a low cost solution. Some models capable of sending a low level signal to your external controller or PLC.

Application	Voltage	Reservoir Size					Wiper Arm	Follower Plate	Low Level Switch Connection	Auto-Fill Shut Off	Power Connection
		2 liter	4 liter	8 liter	12 liter	16 liter					
Grease	12 VDC	96G000	96G038	96G039	-	-	•		-		CPC
		96G003	96G044	96G045	-	-	•		M12 female		CPC
		-	96G331	96G332	-	-	•		5-wire CPC		5-wire CPC
	24 VDC	96G001	96G040	96G041	96G171	96G172	•		-		CPC
		96G005	96G048	96G049	96G199	96G220	•		M12 female		CPC
		96G239	96G238	96G198	-	-	•		5-wire CPC		5-wire CPC
		-	-	96G217	-	-		•	5-wire CPC	•	5-wire CPC
		96G006	96G053	96G192	-	-		•	M12 female		CPC
		96G182	96G184	96G189	96G240	96G241	•		DIN		DIN
		96G243	96G204	96G205	-	-		•	DIN		DIN
	-	96G210	96G213	-	-		•	DIN	•	DIN	
	100-240 VAC	96G002	96G042	96G043	-	-	•		-		DIN
		96G007	96G055	96G056	96G057	96G058	•		M12 female		DIN
		96G008	96G062	-	-	-		•	M12 female		DIN
		-	-	96G207	-	-		•	M12 female	•	DIN
		-	96G202	-	-	-		•	DIN		DIN
	96G320	96G321	96G322	-	-		•	DIN		DIN	
	Oil	24 VDC	96G050	96G051	96G052	-	96G258		M12 female		CPC
100-240 VAC		96G059	96G060	96G061	-	96G291		M12 female		DIN	



G3 PRO

Built-in controller with selectable pump on/pump off timer comes with local manual run and password protection with pre-lube function to initiate lube cycle on start-up. Optional low level sensing available as well as remote manual run.

Application	Voltage	Reservoir Size					M12 Connection for Remote*	Wiper Arm	Follower Plate	Low Level	Power Connection
		2 liter	4 liter	8 liter	12 liter	16 liter					
Grease	12 VDC	96G027	96G135	96G136	-	-		•			CPC
		96G033	96G147	96G148	-	-		•		•	5 Wire CPC**
	24 VDC	96G028	96G137	96G138	-	-		•			CPC
		96G011	96G068	96G069	-	-		•		•	CPC
		96G012	96G073	-	-	-		•		•	CPC
		96G034	96G149	96G150	96G163	96G167		•		•	5 Wire CPC**
		-	96G196	-	-	-		•			DIN
	-	-	96G194	-	-			•	•		5 Wire CPC**
	90-240 VAC	96G029	96G139	96G140	-	-		•			DIN
		96G013	96G075	96G076	96G077	96G078		•		•	DIN
96G014		96G082	-	-	-			•	•	DIN	
Oil	24 VDC	96G070	96G071	96G072	-	-		•		•	CPC
	90-240 VAC	96G079	96G080	96G081	-	-				•	DIN

*G3 Pro pumps with the M12 connection for Remote Manual Run/Monitoring Light use the kit with the connecting cable to provide external low level indication. Choose part number 571032 for 12 VDC pumps or 571033 for 24 VDC and AC pumps.

**G3 Pro pumps with the 5 Wire CPC power connection are compatible with a Remote Manual Run/Monitoring Light Device to provide external low level indication. Choose part number 571030 for 12 VDC pumps or 571031 for 24 VDC pumps.



G3[®] MAX GEN 2 PUMPS



G3 MAX GEN 2

Gain peace of mind with the pump system that makes it easy for you to know that it's working. The G3 Max Gen 2 pumps feature an intuitive, backlit LCD screen. The LCD simplifies programming by displaying a menu to navigate, inspired by GLC X and GLC 4400 controllers. New keypad utilizes membrane switches for durability. Bright LED status lights on the keypad communicate the pump state from a distance, and at a wide angle. New alarm screens are packed with information, including:

- Actual words to identify the alarm.
- Two lines of text with troubleshooting tip.
- Alarm code and symbol for non-English speakers to reference in manual of their language.
- QR code
 - Call to action
 - Links to online "G3 Support" Education Center with manuals, videos, and FAQs
 - Training-On-Demand
- Timer indicates how many hours and minutes the system has been in Alarm state.

Stay connected to your lubrication system anytime, anywhere with optional LTE-m cellular connectivity and the Graco Trace™ cloud platform.

G3 Max Gen 2 pumps come with a complete feature set. To order, simply:

1. Select power connector and voltage

2. Choose reservoir type and size

- Compatible with Single Line Parallel or Series Progressive applications.
- Pressure sensor input accepts analog pressure transducer or normally open pressure switch.
- Include inputs for Machine Count and one Cycle Count.
- Vent Valve output designed for Normally Open vent valves to ensure complete venting of parallel systems.
- Vent Valve output can be repurposed to control an air solenoid for spray applications.

ORDERING OPTIONS

G3 MAX GEN 2 GREASE PUMPS FOR MOBILE APPLICATIONS

Featuring CPC 7-position power connector:

- Utilize the same CPC connector as previous G-Series pumps; now all 7 positions are populated with input and output functions.
- Connections for tri-color remote manual run and LED push-button in CPC (similar to CPC-5 on the EGJ and G-Mini Controller pumps).
- 7-wire cable (sold separately) includes two alarm outputs on DT connector: low level alert/alarm and system alarm (configurable in programming menu).
- Pumps ship with a 2-wire power cable. For compatibility with illuminated remote manual run buttons order a 5-wire or 7-wire cable, plus the LED push-button kit.

	Reservoir Options	Power	2L	4L	8L	12L	16L
Grease	Low Level Paddle	12 VDC CPC-7	96G543	96G547	96G551	96G555	–
		24 VDC CPC-7	96G544	96G548	96G552	96G556	96G560
	Follower Plate and Low Level Paddle	24 VDC CPC-7	96G564	96G568	96G572	–	–
	Follower Plate, Low Level Paddle and AFSO	24 VDC CPC-7	–	–	96G580	–	–

ACCESSORIES

5-WIRE CPC CABLE

Give access to illuminated remote manual run button with tri-color LED.

Part Number	Description
2003467	5-wire CPC cable, 15 ft (4.6 m)
2003896	5-wire CPC cable, 30 ft (9.1 m)

7-WIRE CPC CABLE

Give access to RMRB, plus 2-pin DT connector for alarm outputs.

Part Number	Description
2001714	7-wire CPC cable, 15 ft (4.6 m)

ILLUMINATED LED PUSH BUTTON KITS

Utilized for tri-color remote manual run.

Part Number	Description
25C981	For use with 12 VDC pumps
25C982	For use with 24 VDC pumps

G3[®] MAX GEN 2 PUMPS

ORDERING OPTIONS

G3 MAX GEN 2 PUMPS FOR INDUSTRIAL APPLICATIONS

Features of Max pumps with DIN power connectors:

- DIN Alarm Relay Output: dry contact relay opens or closes when a fault is detected. Acts as a switch but supplies no power (requires external power to energize the circuit when closed). If not connected, use part number 24P731 to cover the DIN connector and maintain IP69K rating.
- M12 output for illuminated remote manual run buttons. Kit 571033 (sold separately) includes M12 cable and is compatible with 24V DIN and AC powered pumps.

		Reservoir Options	Power	2L	4L	8L	12L	16L
Application	Grease	Low Level Paddle	24 VDC DIN	96G545	96G549	96G553	96G557	-
			90-240 VAC DIN	96G546	96G550	96G554	96G558	96G562
		With Spin-off Lid	90-240 VAC DIN	-	-	96G634	-	-
		Follower Plate and Low Level Paddle	24 VDC DIN	96G565	96G569	96G573	-	-
			90-240 VAC DIN	96G566	96G570	96G574	-	-
	Follower Plate, Low Level Paddle and AFSO	24 VDC DIN	-	-	96G581	-	-	
90-240 VAC DIN		-	-	96G582	-	-		
Oil	Low Level Switch	24 VDC DIN	96G591	96G593	96G595	-	96G599	
		90-240 VAC DIN	96G592	96G594	96G596	-	96G600	

ACCESSORY

STACK LIGHT KIT

Compatible with original G3 Max, G3 Max Gen 2 and G5 Pro pumps with DIN alarm relay connector.

Part Number	Description
2008337	Stack light kit, includes red and green stack lights, junction box with DIN cable for alarm relay, AC power supply and M12 cable for stack light.

G3 MAX PUMPS WITH CELLULAR CONNECTIVITY

Stay connected to your lubrication system anytime, anywhere with optional LTE-m cellular connectivity and the Graco Trace™ cloud platform. With Graco Trace, you can:

- View system status
- Monitor lubrication levels
- Configure settings
- Track event, alert and alarm history
- View and share important diagnostics
- Opt in to Receive SMS or email alerts for critical issues
- Accessible from any device with a web browser

Integrated analog level sensor (grease reservoirs only) automatically transmits lubricant levels to the cloud, where system events and errors are logged for fast, accurate analysis.

Reservoir Options	Power	4L	8L	8L with AFSO
MOBILE APPLICATIONS				
Grease Reservoir with Follower Plate and Analog Level Sensor	12 VDC CPC-7	96G601	96G605	96G609
	24 VDC CPC-7	96G602	96G606	96G610
INDUSTRIAL APPLICATIONS				
Grease Reservoir with Follower Plate and Analog Level Sensor	24 VDC DIN	96G603	96G607	96G611
	90-240 VAC DIN	96G604	96G608	96G612
Oil Reservoir with Low Level Switch	24 VDC DIN	96G613	96G615	-
	90-240 VAC DIN	96G614	96G616	-



SCAN TO WATCH
A DEMO OF
GRACO TRACE™





GRACO TRACE™



BOOST PRODUCTIVITY, MAXIMIZE PROFITABILITY

Empower your reliability and maintenance teams to work more efficiently and reduce downtime by streamlining daily lubrication tasks. Built for the modern workforce, the Graco Trace cloud platform is user-friendly and easy to navigate – perfect for technicians in the field. With just a tap or a click, they can access performance history, get support and share critical data instantly.



ELECTRIC PUMPS

MANAGE DEVICES

- Connect via Internet to get instant status
- Remotely monitor reservoir levels and system status from any Internet-connected device (phone, tablet or PC)
- View real-time performance data across your entire pump fleet



COMMUNICATE IN REAL TIME

- See, control, check and clear alarms
- Review and share system event history
- Access performance metrics

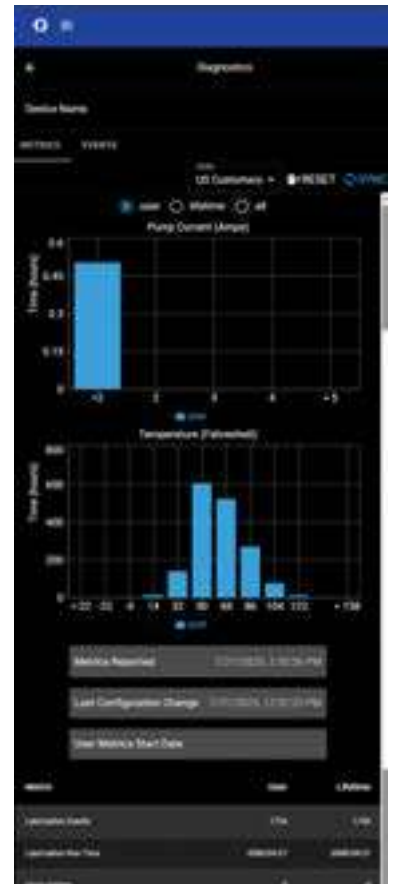
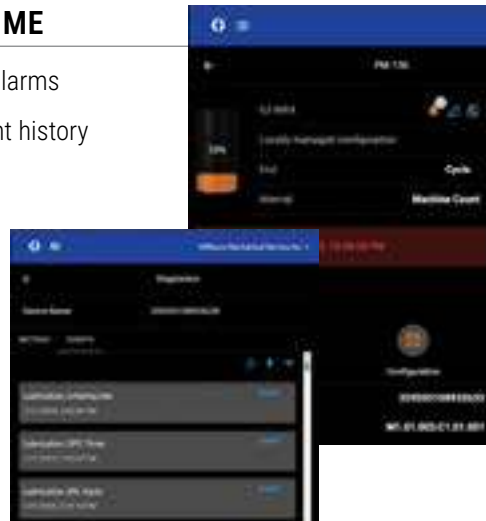

ANALOG LEVEL SENSOR

- Integrated sensor automatically transmits lubricant levels to the cloud, where system events and errors are logged for fast, accurate analysis.



G3® PUMPS

ORDERING OPTIONS



G3 PUMPS WITH AUTO-FILL SHUT OFF

Versatile line of G3 Pumps (Standard, Pro and Max) offered with a factory installed Auto-Fill Shut Off (AFSO). The AFSO feature automatically shuts off lubricant flow from a fill pump to the G3 reservoir once the G3 reservoir is full. The G3 AFSO is based on the same design concept as the Auto-Fill Shut Off offered in conjunction with the robust Electric Dyna-Star product line. Eliminate the need to climb up on equipment to refill an empty reservoir by adding Remote Fill Manifold 77X542 to your system at ground level.

Application	Voltage	G3 Model	Reservoir Size		Wiper Arm	Low Level	Power Connection
			4 liter	8 liter			
Grease	24 VDC	Standard	96G210	96G213	•	• DIN	DIN
			-	96G217	•	•	5-wire CPC*
		Pro	-	96G214	•	•	5-wire CPC*
	90-240 VAC	Max	-	96G580	•	•	7-wire CPC*
		Standard	-	96G207	•	•	DIN
			Pro	-	96G208	•	•
		Max	-	96G582	•	•	DIN

*Low level in CPC: G3 Pro and Max pumps are compatible with a Remote Manual Run/Monitoring Light Device to provide external fault indication. Choose part number 571030 for 12 VDC pumps or 571031 for 24 VDC pumps.

G3 AND G5 AUTO-FILL SHUT OFF FIELD CONVERSION KITS

	Part Number	Description
	571286	G3 AFSO 4L field conversion kit
	571287	G3 AFSO 8L field conversion kit
	571288	G3 AFSO 12L field conversion kit
	571289	G3 AFSO 16L field conversion kit



ORDERING OPTIONS

G-SERIES RESERVOIR UPSIZE AND CONVERSION OPTIONS

G3, G5 and Electric Grease Jockey pumps all consist of a base and a reservoir. The bases are all designed for 2 L reservoirs, so to convert to a larger a reservoir, a 2 L to 4 L adapter is required.

Size	Oil Reservoirs	Grease Reservoirs	
	8 L and larger oil reservoirs simply require one 4 L oil reservoir plus expansion rings (qty.)	Upsize (with Wiper Arm)	Auto-Fill Shut Off*
4 liter	571182	571155	571286
8 liter	571182 (1) + 25C764 (1)	571156	571287
12 liter	571182 (1) + 25C764 (2)	571157	571288
16 liter	571182 (1) + 25C764 (3)	571158	571289

*AFSO reservoir kits do not include adapter ring. Order p/n 574002 separately when converting from a 2 L reservoir to an AFSSO reservoir.

G3 PUMP ELEMENTS

	Part Number	Description
	571041	Pump element – same adjustability as the pump included with G3 pumps.
	571041PK	100-pack of replacement pump elements

G3 PUMP OUTPUT UNION KITS

Pump element(s) sold separately.







	Part Number		Description
	Three (3) Pumps	Two (2) Pumps – Left and Right	
	571026	571063	For systems without a direct-mount vent valve installed on the first pump outlet.
24P295	24P296	For systems with a direct-mount vent valve installed on the first pump outlet.	

Each G3 includes one pump element when it ships. Add one or two more (p/n 571041) and the appropriate union kit if needed for your application.

G3® PUMP ACCESSORIES

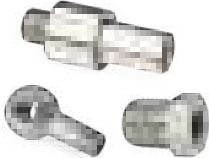
ORDERING OPTIONS

G-SERIES PRESSURE RELIEF VALVE (PRV) OPTIONS

	Part Number		Description
	Outlet Thread		
	NPT	BSPP	
	571028	571071	Adjustable return-to-reservoir pressure relief kit – 500 to 3,500 psi (35 to 241 bar).
	556420*	-	Male run tee – 1/4 NPT, use with 571028 kit to increase pressure limit to 5,000 psi.*
	26C030*	26C176*	Pressure relief to atmosphere kit – 5,000 psi (345 bar).*
	26A910	-	Pressure relief to atmosphere kit – 4,000 psi (276 bar).
	16V999	-	Pressure relief to atmosphere valve – 1/8 in NPT male, 5,000 psi (345 bar).*
	115122	-	Pressure relief to atmosphere valve – 1/8 in NPT male, 4,000 psi (276 bar).
	571058	571070	Pressure relief-to-atmosphere kit – requires one of the following six pressure relief valves:
		563156	Pressure relief valve – 750 psi (52 bar)
		563157	Pressure relief valve – 1,000 psi (69 bar)
		563158	Pressure relief valve – 1,500 psi (103 bar)
		563159	Pressure relief valve – 2,000 psi (138 bar)
		563160	Pressure relief valve – 2,500 psi (172 bar)
		563161	Pressure relief valve – 3,000 psi (207 bar)
	25U706		G-Series Gauge And Relief Valve Adapter Kit – includes 5,000 psi/350 bar gauge (2007096), street cross fitting (133643) and 1/4 NPT x NPSM swivel fitting (156823). Allows connection of gauge, relief valve and outlet fitting to pump outlet. NPSM swivel fitting installs in the G-Series pump outlet for easy clocking of the complete assembly. Relief valve sold separately – choose from one of the options above.
	2008155		G-Series Gauge and Return-to-Reservoir Adjustable Pressure Relief Valve Kit – includes all of the parts in kit 25U706, plus adjustable PRV with elbows and tubing to plumb back to the reservoir of a G3 or G-Mini pump.



*Not for use with G-Mini pumps.



G3[®] PUMP ACCESSORIES



ORDERING OPTIONS

G-SERIES REMOTE MANUAL RUN/MONITORING LIGHTS



	Part Number		M12 Cable Included?
	12 VDC	24 VDC*	
	571030	571031	No. Use with CPC-5 power cables on G3 Pro pumps.
	25C981	25C982	No. Use with CPC-5 or CPC-7 power cables on G3 Max pumps.
	571032	571033	Yes. 16.5 ft (5 m). Use with pumps that have M12 input for manual run.

*24 VDC is also used with AC powered G-Series pumps.

G3 MOUNTING BRACKET OPTIONS



	Part Number	Description
	125910	G3 pump mounting L-bracket
	571159	G3 reservoir support bracket for mobile installations – secures 12 and 16 liter reservoirs.
	132187	G-Series isolation kit (vibration damper)

G3 PRO PROTECTIVE FRONT COVER KITS

	Part Number	Description
	571036	Black
	571255	Clear
	24Z962	Clear with cutouts for Reset and Manual Run buttons

GREASE PRESSURE GAUGES







Stainless steel case, liquid filled (glycerin), 0-5,000 PSI (0-350 bar).

	Part Number	Thread	Mount	Suggested Use
	115523	1/4 NPT brass	Back	Vent valve gauge port
	2007096		Bottom	Tee into pump outlet with part number 556420

G3[®] PUMP ACCESSORIES





ORDERING OPTIONS

G-SERIES RESERVOIR FILLING ACCESSORIES

	Part Number	Description
	24M644	High capacity fill coupler with quick disconnect and dust cover. G3 Standard and Pro pumps: Installs in 1/4 in NPT on front or either side of pump base. G3 Max pumps: Installs in 1/4 in NPT port on either side of pump base. For applications requiring a 90 degree elbow, add p/n 15M045.
	77X542	Remote-fill manifold with vent – for use with reservoirs that have AFSO.
	121474	Female coupler – mates to 24M644 fill stud and 77X542 remote fill manifold.
	2006967	Cartridge filler pump kit – for use with 14 oz (400 g) grease cartridges. Kit includes manual pump 2006597 and G3 adapter fitting 2000201.
	2000201	G3 adaptor for Cartridge filler pump, installs in unused pump socket (3/4-16 thread). For use with 2006597 fill pump.
	2000200	G-Mini adaptor for Cartridge filler pump, installs in unused pump socket (M20 thread). For use with 2006597 fill pump.
	571064	Cold temperature fill relief kit – prevents over-pressurizing when filling in cold temperatures.

REFILL PUMP KITS

Each kit includes 121474 coupler.



	Part Number	Description
	247886	Manual hand pump for 35 lb pail
	2002295	LD Series 35 lb fill pump kit
	2002296	LD Series 120 lb fill pump kit
	26A320	Mini Fire-Ball 400 lb fill pump kit



ORDERING OPTIONS

G3 PUMP ENCLOSURE KITS



Ideal for fracturing equipment lubrication, these kits contain a G3 pump, valve assemblies, durable enclosure and mounting assemblies.

	Part Number	Description
	132090	Triplex, 12V, G3 Pro
	132091	Triplex, 24V, G3 Pro
	132154	Triplex, 24V, G3 Standard
	132092	Quintuplex, 12V, G3 Pro
	132093	Quintuplex, 24V, G3 Pro
	132155	Quintuplex, 24V, G3 Standard
	132089	Standalone enclosure with G3/MSP mounting panel
	132188	G3/MSP mounting panel
	132163	Isolator kit

G3[®] PUMP ACCESSORIES



ORDERING OPTIONS

MACHINE COUNT SENSORS

	Part Number	Description
	17J939	G3 machine count inductive sensor – 12-24 VDC. NPN normally open, M12 male, 5 mm sensing distance.
	557781	"Microswitch" dry contact limit switch – AC/DC. Can be wired N.O. or N.C. Use with cable 124300 and cord grip 260067.

PRESSURE SENSORS



Use to read pressure in an injector-based system. After injectors dispense, controller or G3 Max will trigger pump shut down and vent.

	Part Number	Voltage and Sensor Type	Range	Porting	Electrical Connector	Notes
	2010651	9-36 VDC, Transducer	0.5 to 4.5 VDC, 0 to 5,000 PSI (345 Bar)	1/4 NPT male	M12 male	M12 connector pin assignments match "P" input of the G3 Max Gen 2 pumps; use cable 124333 for easy, plug-and-play wiring.
	24K414	10-32 VDC, PNP	Set: 290 to 5,800 PSI (20 to 400 bar) Reset: 175 to 5,685 PSI (12 to 392 bar)	1/4 NPT male	M12 male	Dual pressure setting adjustments. M12 connection makes it easy to wire to a G3 Max.

For more pressure switch options and more details, see page 207.

SOLID STATE PROXIMITY SWITCHES

Use with Series Progressive Divider Valves to count cycles.

	Part Number	Voltage and Switch Type	Divider Valve	Thread	Electrical Connector
	17L983	10-36 VDC, PNP	MSP and MHH	7/16-20	M12 male
	17L879		CSP	M11	

CABLES FOR SOLID STATE PROXIMITY SWITCHES

Use with a G3 Max when connecting directly to the pump, when LED cycle indication is required.

Part Number	Proximity Switch Connection	2nd Connection	Length	Notes
25M602	M12 female, straight	Flying leads	16.5 ft (5 m)	PNP switch with NPN LED – requires 124594
25M603		M12 male, straight		PNP switch with NPN LED
25U234				2 ft (0.6 m)







For more proximity switch and cable options, and more details, see Proximity Switches section on pages 165-166.



ORDERING OPTIONS

OTHER WIRING ACCESSORIES FOR G-SERIES PUMPS

Use with a G3 Max or G-Mini when connecting directly to the pump, when LED cycle indication is not required.

	Part Number	1st Connection	2nd Connection	Length	Notes
	126331	M12 female, straight	Flying leads	16.5 ft (5 m)	Requires 124594 when used with G3 Max or G-Mini
	124300	M12 male, straight	Flying leads	16.5 ft (5 m)	Accessory cable – add 124301 when connecting to an M12 sensor.
	124333	M12 female, straight	M12 male, straight	16.5 ft (5 m)	Accessory cable
	124301	M12 female, straight	–	–	Connector for 6-8 mm cable
	124594	M12 male, straight	–	–	Connector for 6-8 mm cable
	124640	DIN female	Flying leads	6.6 ft (2 m)	Output cable for DIN alarm relay (G3 Max)
	127123	DIN female	–	–	Field wireable DIN connector
Image Coming Soon	24P731	DIN power/ alarm cover	–	–	With gasket and screw, IP69K rated

G3[®] PUMP ACCESSORIES

ORDERING OPTIONS

DIRECT-MOUNT VENT VALVES FOR G3 PUMPS

G3 pump vent valve kits include adjustable pressure relief, 500-3,500 psi (35-241 bar), and mount directly to a G3 pump.

NORMALLY-OPEN VENT VALVES FOR USE WITH G3 MAX PUMPS

Includes power cable and 5000 psi/350 bar dual range pressure gauge.

	Voltage	Part Number		Power Cable
		NPT	BSPP	
	12 VDC	2008943	2008945	Included
	24 VDC	2008944	2008946	Included
	AC pumps	2008944	2008946	Included

G3 Max AC pumps are 24 VDC internally, so they use 24 VDC accessories, including the vent valve and pressure sensors.

NORMALLY-OPEN VENT VALVES FOR USE WITH G3 STANDARD PUMPS

Power cable and pressure gauge not included. Order separately.



	Voltage	Part Number		Power Cable
		NPT	BSPP	
	12 VDC	24M478	24M481	24N402
	24 VDC	24M479	24M482	24N402
	115 VAC	24M480	24M483	2007482*
	230 VAC	24N182	24M484	2007482*

*24N351 is alternative patch cable which connects directly to DIN power connection.

LOW PRESSURE VENT VALVE FOR USE WITH G3 PUMPS

Part Number	Description
2001401	Similar to 24M483 (above) but with a lower adjustment range, this vent valve is intended for use with piston distributors such as Injecto-Flo. Includes adjustable pressure relief, 200-750 psi (14-52 bar), factory set to 200 psi (14 bar). BSPP outlet thread. Normally Open solenoid, for use with G3 Standard pumps. 115 VAC with DIN connector, requires power cable 2007482 or 24N351.

VENT VALVES ACCESSORIES FOR G3 STANDARD SYSTEMS

	Part Number	Description
	24N402	Vent valve power cable – normally open, 12 or 24 VDC valve, Deutsch connector, 6 feet
	2007482	Vent valve power cable – normally open, 115 or 230 VAC valve, DIN connector, 15 feet
	24N351	Save installation time and money without the need for additional cabling. Patch cable connects vent valves with DIN connection directly to the DIN Pump Power connector.



G3[®] HF PUMP

INJECTOR-BASED AUTOMATIC LUBRICATION GREASE PUMPS

Designed for off-road mobile equipment, low-end-sized mining machines, and medium to high-end-sized construction machines using injectors, the G3 HF offers a smarter combination of rugged durability, safety and intuitive tech. It's the next generation of automatic lubrication – built for today's cost- and safety-conscious operations.

Versatility

- Quickly fill hard to pump grease from the top of the reservoir

Usability

- Easy-to-use, internal or external controller options
- Optional cellular or Bluetooth[®] connectivity

Durability

These models take the best of Graco's field-proven G3 Max and G3 Standard pumps and upgrade with:

- A more robust motor and gear box
- Heavier-duty pump elements

Safety

Auto-Fill Shutoff options

- Avoid unsafe filling conditions
- Ability to install pump in hard-to-access locations

Repairability

- Easy-to-access components simplify troubleshooting and repair
- Repair without removing pump from equipment



ELECTRIC PUMPS

TYPICAL APPLICATIONS

- Off-road mobile equipment
- Low-end-sized mining equipment
- Construction machinery utilizing injector-based lubrication

TECHNICAL SPECIFICATIONS

Power Source	24 VDC (18-30 VDC; 3.2 amp current (4 amp with vent valve), inrush/locked rotor 30 amp)
Fluids Handled	NLGI #000 - #2 Greases
Operating Temperature	-22°F to 158°F (-30°C to 70°C)
Reservoir Size	4-, 8- or 12-liters
Control Option	Built-in (G3 HF Max models), GLC X or GLC 2200 (G3 HF Standard models)
Output Pressure	3,500 psi (24.1 MPa, 241 bar)
Pump Output	1.5 in ³ (24.6 cm ³) / per minute
Pump Outlet	1/4 -18 NPSF. Mates with 1/4 - 18 NPT male fittings
Protection Grade	IP69K
Instruction Manual	X022361 (G3 HF Standard) / X030566 (G3 HF Max)

G3[®] HF PUMP

ORDERING OPTIONS

G3 HF STANDARD

FOR USE WITH GLC CONTROLLER (sold separately)

All models include pressure switch and paddle-style low-level switch. Order part number 2011788 separately (GLC 2200 Controller and Harness Kit).

Reservoir Size			Follower Plate	Auto-Fill Shutoff (AFSO)
4 L	8 L	12 L		
96G400	94G411	96G414	–	–
–	96G412	–	•	–
–	–	96G415	–	•

FOR USE WITH GLC X CONTROLLER (sold separately)

All models include pressure transducer and paddle-style low-level switch. Order part number 2011789 separately (GLC X Controller and Harness Kit).

Reservoir Size			Follower Plate	Auto-Fill Shutoff (AFSO)
4 L	8 L	12 L		
96G410	–	96G416	–	–
–	96G407	–	•	–
–	96G413	–	•	•
–	–	96G417	–	•

G3 HF MAX

All models include pressure transducer and paddle-style low-level switch.

Reservoir Size		Follower Plate	Auto-Fill Shutoff (AFSO)
4 L	8 L		
96G617	96G619	–	–
–	96G635	•	–
–	96G636	•	•

G3 HF MAX WITH CELLULAR DATA CONNECTIVITY

All models include pressure transducer and reservoir level transducer.

Reservoir Size		Follower Plate	Auto-Fill Shutoff (AFSO)
4 L	8 L		
96G627	96G629	•	–
–	96G637	•	•

ACCESSORIES

Part Number	Description
25C987	Replacement HF pump element
2012025	2-pump manifold kit with vent valve and pressure switch
2012394	2-pump manifold kit with vent valve and pressure sensor
2011787	Union tube kit to combine third pump element (requires a 2-pump manifold kit)
124575	Replacement 24 VDC solenoid



G3[®] HAMMER PUMP

IDEAL FOR HYDRAULIC BREAKER/HAMMER LUBRICATION

Extend the life of your hydraulic hammer/breaker tools and provide a breakthrough for your budget. The new G3 Hammer Pump offers convenient top fill access, enabling chisel paste to be quickly added to the reservoir to avoid halting operations. Designed for harsh, high vibration environments, the G3 Hammer Pump ideally handles high shock hammer/breaker applications with ease.

Spin-Off Reservoir Cover

Quickly fill hard to pump grease from the top of the reservoir.

Robust Cover Design

Reinforced ribs to withstand high vibration and shock applications.



Multiple Reservoir Options

Available in both 4 and 8 liter capacities.

Up to Three Pump Elements

- 0.25 in³/min (4 cm³/min) per element.
- 5,100 psi (351.6 bar).

Power and Low Level Options

CPC or DIN-style connectors make for easy, no hassle installations.

Versatile Pump Elements

Built to withstand the harshest of greases, such as chisel paste and other greases containing additives.



TYPICAL APPLICATIONS

- Hydraulic breakers/hammers
- Carrier or pedestal mounted





TECHNICAL SPECIFICATIONS

	96G278	133789	96G279	133791
Power Source	18-30 VDC; 2.5A current, 60W, inrush/locked rotor 6A			
Fluids Handled	Chisel Paste, NLGI #000 to #2 Greases			
Operating Temperature	-40°F to 158°F (-40°C to 70°C)			
Reservoir Size	4 Liter		8 Liter	
Control Option	Control pump via external control method			
Pump Elements	Ships with one pump element, add up to two additional pump elements			
Output Pressure	5,100 psi (35.1 MPa, 351.6 bar)			
Pump Output	0.25 in ³ /min (4 cm ³ /min) per pump element			
Pump Outlet	1/4-18 NPSF, mates with 1/4-18 NPT male fittings			
Protection Grade	IP69K			
Instruction Manual	332291			

G3[®] HAMMER PUMP

ORDERING OPTIONS

G3 24 VDC HYDRAULIC BREAKER/HAMMER CHISEL PASTE LUBRICATION PUMPS

	Part Number	Description
	96G278	4 Liter, 5-Wire CPC Cable
	96G279	8 Liter, 5-Wire CPC Cable
	133789	4 Liter, External Low Level, 2 DIN Cables
	133791	8 Liter, External Low Level, 2 DIN Cables

ELECTRIC PUMPS



G3® DUAL-LINE PUMP

RELIABLE DROP-IN DUAL-LINE OR TWIN PUMP UPGRADE

Designed for a seamless pump upgrade or replacement in existing dual-line lubrication systems for yellow iron equipment. Effortlessly upgrade your dual-line or twin pump system while ensuring compatibility with the machine's existing dual-line metering devices.

Versatile Reservoir Options

Choose from durable 4- or 8-liter U.V.-resistant, high-impact reservoirs.

Easily Accessible Components

Streamline maintenance and troubleshooting.

Proven Components

Field-proven pump elements and motors engineered to excel in the toughest applications.

User-Friendly Pump Management

Effortlessly adjust pump parameters using the built-in controller (G3 Max models) or included GLC X® controller (G3 Standard models).

Universal Mounting Bracket

Easily install into existing dual-line systems.

Fail-Safe Reversing Valve

Minimize failures with a mechanically controlled reversing valve.

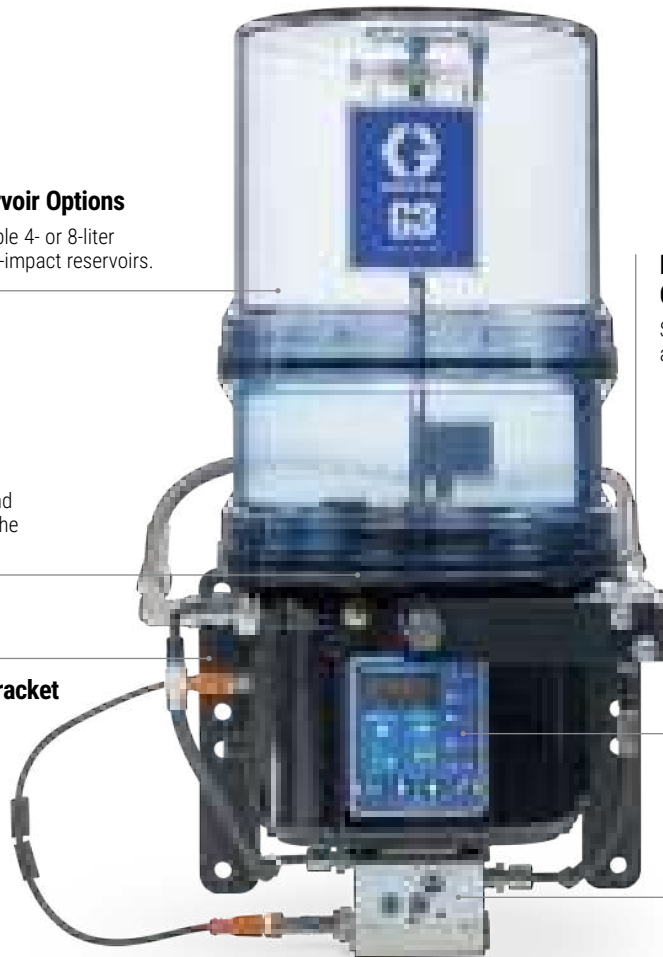

ELECTRIC PUMPS

TYPICAL APPLICATIONS

- Construction equipment
- Mining equipment
- Agricultural equipment









TECHNICAL SPECIFICATIONS

Power Source	18-30 VDC
Fluids Handled	NLGI #000 to #2 greases
Operating Temperature	14°F to 122°F (-10°C to 50°C)
Reservoir Size	4 or 8 liters
Control Option	Built-in (G3 Max models), GLC X (G3 Standard models)
Pump Elements	Ships with three pump elements if not specified in description
Output Pressure	3,500 psi (24.1 MPa, 241 bar)
Pump Output	0.25 cu in/min (4 cc/min) per pump element
Valve Outlet	(2) 1/4 in NPT female
Protection Grade	IP69K

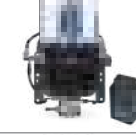
G3[®] DUAL-LINE PUMP

ORDERING OPTIONS

G3 DUAL-LINE PUMPS

	Part Number	Description
	2002240	G3 Max, 24 VDC, 4 liter with Internal Controller, 3 Pump Elements
	2002241	G3 Max, 24 VDC, 8 liter with Internal Controller, 3 Pump Elements
	2002243	G3 Standard, 24 VDC, 4 liter with GLC X Controller, 3 Pump Elements
	2002244	G3 Standard, 24 VDC, 8 liter with GLC X Controller, 3 Pump Elements
	2006886	G3 Max, 24 VDC, 4 liter with Internal Controller, 2 Pump Elements
	2006887	G3 Max, 24 VDC, 8 liter with Internal Controller, 2 Pump Elements
	2002247	G3 Standard, 24 VDC, 4 liter with GLC X Controller, 2 Pump Elements
	2002248	G3 Standard, 24 VDC, 8 liter with GLC X Controller, 2 Pump Elements

ACCESSORIES

Part Number	Description
2002702	3 Pump Element Union Kit with Pressure Relief Valve
2006225	G3 to Dual-Line Conversion Kit – Reversing Valve, Union Kit, Mounting Bracket
2004626	NPT to M10 Fitting
2002258	Reversing Valve Assembly
2004545	Reversing Valve Remote Mounting Kit
2004968	Reversing Valve Rebuild Kit



G5[®] PUMPS

DESIGNED FOR QUINTUPLEX PACKING LUBE

Greater profit is within reach with Graco G5 pumps. Equipped with five pump elements for more versatile and simpler grease operations, the G5 has been designed specifically for the harsh demands of fracking operations.



Robust Reservoir

U.V.-resistant, high-impact reservoirs to meet the needs of your equipment.

Auto-Fill Shutoff Option

Completely fill the reservoir while avoiding costly spills with an optional AFSO.

Reservoir Wiper Arm

Stirring paddle with wiper arm to keep material from separating.

Flexible Power Options

Two CPC-style connectors with low level output options make for easy, hassle-free installations.

Five Pump Elements

G5 comes standard with five adjustable pump elements installed.

Optional Pressure Relief Valves

Install up to five pressure relief valves with the option to vent back into the reservoir.

Two Controller Options

Use your existing machine's controller or choose the G5 Pro's built-in controller.

TYPICAL APPLICATIONS

- Quintuplex frac pumps
- Pumpjacks
- Other pump-to-point applications

TYPICAL FLUIDS

- Packing lube

TECHNICAL SPECIFICATIONS

Maximum Working Pressure	4,250 psi (293 bar)
Power	24 VDC
Operating Temperature	-40°F to 158°F (-40°C to 70°C), depending on lubricant used
Reservoir Size	4 and 8 liter (Enclosures fit 4 liter only)
Maximum Run Time	30 minutes
Control Options	Standard (no controller) or Pro (timer)
Adjustable Pump Output Per Element Per Minute*	0.155 in ³ (2.54 cm ³) [no shim] 0.104 in ³ (1.70 cm ³) [1 shim] 0.055 in ³ (0.90 cm ³) [2 shims]
Enclosure Dimensions (L x W x H)	Small – 17.75 in x 14.94 in x 13.00 in (45 cm x 38 cm x 33 cm) Large – 22 in x 17 in x 18 in (56 cm x 44 cm x 46 cm)
Certifications/Ratings	CE, UKCA
Instruction Manual	Standard – 3A8847 / Pro – 3A8848 / Pro with Enclosure – 3A9275

*Shims not included with pump element. Please see shim kit under Accessories section.

G5[®] PUMPS

ORDERING OPTIONS



G5 24 VDC STANDARD GREASE PUMPS

	Part Number	Description
	95G102	4 liter, 2-pin CPC with 15 ft power cable
	95G103	4 liter, external low level in CPC, with 15 ft power cable
	95G109	4 liter, external low level in CPC, JIC side vent, no power cord, (order cable 2003467 separately)
	95G112	8 liter, 2-pin CPC with 15 ft power cable
	134178	Assembly of 95G109 with pressure relief valves installed on all five outlets



ORDERING OPTIONS

G5 24 VDC PRO GREASE PUMPS

	Part Number	Description
	95G104	4 liter, low level with controller, 5-pin CPC
Image Coming Soon	95G108	4 liter, auto-fill shutoff, 5-pin CPC
Image Coming Soon	95G110	4 liter, auto-fill shutoff, DIN power, DIN alarm
Image Coming Soon	95G111	8 liter, auto-fill shutoff, DIN power, DIN alarm
	134179	Assembly, 4 liter, auto-fill shutoff, DIN power, DIN alarm, pressure relief valves, return to reservoir, controller cover
	134180	Assembly, 8 liter, auto-fill shutoff, DIN power, DIN alarm, pressure relief valves, return to reservoir, controller cover

G5[®] PUMP ACCESSORIES

ORDERING OPTIONS

G5 24 VDC GREASE PUMPS WITH ENCLOSURE

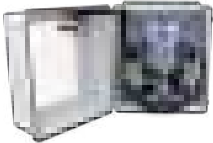
	Part Number	Description
	134410	Assembly – small enclosure, G5 Standard pump, 4 liter, pressure relief valves
	134411	Assembly – small enclosure, G5 Standard pump, 4 liter, pressure relief valves, return to reservoir
	134010	Assembly – small enclosure, G5 Pro pump, 4 liter, pressure relief valves, run lights
	134011	Assembly – large enclosure, G5 Pro pump, 4 liter, auto-fill shutoff, pressure relief valves, run lights







G5 PUMP ENCLOSURE ACCESSORIES

Part Number	Description
132095	Enclosure rubber grommet for power or AFSO
133919	Flying lead AMP connector
133994	Run light kit – green
133995	Run light kit – red
134142	Fluid manifold assembly – small enclosure
134167	Fluid manifold assembly – large enclosure
134169	Small bare enclosure
134170	Large bare enclosure
132163	Enclosure isolator kit



ORDERING OPTIONS

G5 PUMP ACCESSORIES

	Part Number	Description
	571041	Pump element
	571041PK	100-pack of replacement pump elements
Image Coming Soon	133960	Return to reservoir kit – includes no pressure relief valves
Image Coming Soon	133958	Return to reservoir kit – includes five pressure relief valves
	133910	Pressure relief valve, 4,000 psi (276 bar)
	133991	Pressure relief valve kit, 4,000 psi (276 bar) – includes five pressure relief valves
Image Coming Soon	571286	Auto-fill shutoff reservoir kit
Image Coming Soon	133457	Pump shim kit – includes five shims
	132187	G-Series isolation kit (vibration damper)
	2003467	CPC 5-wire power cord
	125910	G5 pump mounting L-bracket
	24Z962	Pro controller protective cover kit. Clear with cutouts for Reset and Manual Run buttons

LUBE MASTER®

BUILT FOR SEVERE-DUTY ENVIRONMENTS

The Lube Master is a rugged pump package designed for demanding applications. The adjustable output and anti-friction drive bearings make it both reliable and efficient. Rugged cast aluminum main body and heavy-duty internal components deliver consistent performance in harsh applications. With several reservoir choices and accessories to choose from, the Lube Master pump can be easily customized to meet virtually all application needs.

Reservoir Options

For oil or grease, 12 or 20 pint/pound, plastic or metal.

Low Level Switch Options

Available for both oil and grease reservoirs.

Continuous Duty

1/2 hp motors in 1 phase or 3 phase, choose from two different RPMs for each.

Drive and Mounting Base

- Choose from two gearbox ratios to configure your flowrate range.
- Choose floor mount or wall mount.



Adjustable Pump Displacement

Set the pump output with the turn of a wrench.

THEORETICAL CALCULATED DISCHARGES OF LUBE MASTER

Motor Speed (RPM)	60:1 Gear Ratio		10:1 Gear Ratio	
	Discharge Output in ³ (cm ³)			
	Minimum	Maximum	Minimum	Maximum
1,140	0.19 (3.11)	0.95 (15.57)	1.14 (18.69)	5.7 (93.42)
1,725	0.28 (4.59)	1.48 (23.44)	1.72 (28.19)	8.62 (141.28)

TECHNICAL SPECIFICATIONS

Cycle Rate	1-175 strokes per minute
Output Volume Per Minute	See chart below
Max Output Pressure	5,000 psi (340 bar)
Reservoir Material	Plastic or metal, cylindrical
Reservoir Size	Oil – 12 pint, 20 pint / Grease – 12 lb, 20 lb
Motor	115/230 VAC, 230/460 VAC, 60 Hz
Instruction Manual	3A2781

TYPICAL APPLICATIONS

- Cement plants
- Paper processing
- Steel mills
- Other harsh environments

TYPICAL FLUIDS

- Oil
- Grease up to NLGI #2



ORDERING OPTIONS

POPULAR LUBE MASTER ASSEMBLY MODELS

Pressure Gauge 2007096 is included with every LMxxxx assembly.

GREASE PACKAGES

Part Number	Reservoir		Base Mounting Configuration	Drive Ratio	Motor – All motors are 1/2 hp, 60 Hz		Low Level Switch
	Material	Capacity			RPM	Voltage	
LM6334	Plastic	20 pound*	Floor	10:1	1,725	230/460 VAC, 3-phase	SPDT, 15 amp
LM6544					1,140	115/230 VAC, 1-phase	SPDT, 15 amp
LM6611			Wall	60:1	None		None
LM7534	Metal	Floor	1,725		230/460 VAC, 3-phase	SPDT, 15 amp	
LM8534			20 pound*		1,725	230/460 VAC, 3-phase	SPDT, 15 amp



*Nominal grease reservoir size is based on a direct conversion of oil reservoir capacity and does not reflect volume loss due to the follower and spring. Actual volume of "12 lb" reservoir is 6 lb (3 L). Actual volume of "20 lb" reservoir is 12 lb (6 L).

OIL PACKAGES

Part Number	Reservoir		Base Mounting Configuration	Drive Ratio	Motor – All motors are 1/2 hp, 60 Hz		Low Level Switch
	Material	Capacity			RPM	Voltage	
LM9521	Metal	Overhead Supply	Floor	60:1	1,725	115/230 VAC, 1-phase	None



ACCESSORIES

PRESSURE INDICATORS

	Grease – Aluminum-colored disk, 2,350 PSI (162 bar)	Oil – Yellow-colored disk, 1,450 PSI (100 bar)	Description
		563184	
	563385	563384	High-pressure blowout switch kit*
	563965	563962	Package of 6 blowout disks



*Each kit requires approximately 3 ft of 1/4 in OD copper tubing, not included.

LOW LEVEL SWITCHES – GREASE

	Part Number	Description
		563322
564318		High/low level switch kit, for metal grease reservoirs only
	564377	Explosion-proof LL switch for grease reservoirs. (Class I, Group C and D; Class II, Group E, F and G)



ORDERING OPTIONS

LOW LEVEL SWITCHES – OIL

	12 Pint	20 Pint	Description
	563015	563016	SPST, 10 watt, most popular option
	563316	563317	SPDT, 15 amp, for use with heavy or stringy oils

PUMP REPAIR KITS

At the heart of all current Lube Master pump packages is pump part number 563380. There are three repair kits for the pump and some of the parts overlap because each kit includes some of the same seals. To completely rebuild the pump, all three kits are required and some extra parts will remain because of this overlap.

	Part Number	Description
	563915	Driveshaft Kit. Includes the driveshaft, cam, bearings and related seals and hardware.
	563921	Seal Kit. Includes seals and small hardware.
	563916	Standard Output Manifold Kit. Includes pump piston and cylinder, output manifold block and related seals and hardware.

RESERVOIR REPAIR KITS

	Part Number	Description
	562902	Polycarbonate tube with u-cup seal for part numbers 562892 (12 pt) and 562896 (12 lb).
	562903	Polycarbonate tube with u-cup seal for part numbers 562893 (20 pt) and 562897 (20 lb).

REPLACEMENT GEAR REDUCERS

Floor Mount and Wall Mount drives use the same gear reducers.

	Part Number	Description
	557160	10:1 Gear Reducer
	557161	60:1 Gear Reducer



ORDERING OPTIONS

LUBE MASTER MODULAR COMPONENTS

Use these parts to configure and build a Lube Master assembly whenever the specific combination is not offered as a configured part number.

LUBE MASTER BARE PUMP

Part Number	Description
563380	Lube Master bare pump

Note: When ordering 563380 for use with a grease reservoir, a fill stud 557374 is required. Mating coupler 558906. Order both parts separately.

RESERVOIR OPTIONS

Part Number	Description
562892	12 pt plastic oil reservoir (OPA)
562893	20 pt plastic oil reservoir (OPB)
562895	20 pt metal oil reservoir (OMB)
562896	12 lb plastic grease reservoir (GPA)
562897	20 lb plastic grease reservoir (GPB)
562898	12 lb metal grease reservoir (GMA)
562899	20 lb metal grease reservoir (GMB)
562908	Power Prime/Overhead Supply (OHS)

DRIVE OPTIONS

Part Number	Description
563383	Clutch drive with ratchet arm (DOA)
563388	10:1 reduction, floor-mounting base (DOB)
563386	10:1 reduction, wall-mounting base (DOC)
563389	60:1 reduction, floor-mounting base (DOD)
563387	60:1 reduction, wall-mounting base (DOE)

Note: 10:1 and 60:1 drives each contain all required mounting hardware: mounting base, coupler, coupler guard, nuts, bolts and washers.

MOTOR OPTIONS

Part Number	Description
557271	1/2 HP, 115/230 VAC, single phase, 60 Hz, 1,725 rpm (MOA)
557270	1/2 HP, 230/460 VAC, 3-phase, 60 Hz, 1,725 rpm (MOB)
557272	1/2 HP, 115/230 VAC, single phase, 60 Hz, 1,140 rpm (MOC)
557273	1/2 HP, 230/460 VAC, 3-phase, 60 Hz, 1,140 rpm (MOD)

PRESSURE GAUGE

Part Number	Description
2007096	Liquid-filled 0-3000 psi gauge (G3)

PRESSURE RELIEF VALVES (required for safety)

Part Number	Description
563179	Standard Blowout, 1,450 psi (100 bar), Oil (POA)
563184	Standard Blowout, 2,350 psi (162 bar), Grease (POB)
563384	High-Pressure Blowout Switch, 1,450 psi (100 bar), Oil (POC)
563385	High-Pressure Blowout Switch, 2,350 psi (162 bar), Grease (POD)

Note: 563384 and 563385 each require approximately 3 feet of 1/4 in OD tubing, which must be obtained from a 3rd party source.

LOW LEVEL OPTIONS

Part Number	Description
563316	12 pt oil, SPDT, 15 amps (LOA)
563317	20 pt oil, SPDT, 15 amps (LOB)
563015	12 pt oil, SPST, 10 watts (LOE)
563016	20 pt oil, SPST, 10 watts (LOF)
563322	12 and 20 lb grease, SPDT (LOC)
564318	High/low level switch kit (for METAL grease reservoirs 562898 and 562899 only)
564377	Explosion-proof LL switch for grease reservoirs, Class I, Group C and D; Class II, Group E, F and G (LOH)

MINIATURE METER-FLO® PUMP

VERSATILE, ALL-IN-ONE PUMP PACKAGE

Designed for use with virtually any type of Series Progressive or Single Line Resistive oil lubrication system. The Miniature Meter-Flo's rugged steel reservoir and motor assembly withstands the toughest applications. Capable of high volumetric output operating continuously at pressures up to 2,000 psi (138 bar).



Built-in Pressure Relief

Returns excess oil to the reservoir with no mess.

Continuous Duty Motor

Ideal for circulating oil systems.

Sensor Options

- Factory-installed low level.
- Pressure switch sold separately.

Oil Level Sight Glass

Provides visual indication of oil level.

Steel Oil Tank

Rugged construction offered in three sizes.

TYPICAL APPLICATIONS

- Ideal for smaller series progressive systems requiring continuous lubrication
- Adjustable, built-in pressure relief valve makes MMF packages compatible with resistive orifice systems

TYPICAL FLUIDS

- Oil – 160 to 15,000 SUS

TECHNICAL SPECIFICATIONS

Output Volume Per Minute	1, 5, 8, 14 in ³ (16, 82, 131, 229 cm ³)
Output Pressure	300-2,000 psi (20.7-138 bar)
Reservoir Material	Metal, Rectangular
Reservoir Size	1.5, 3 or 5 gal (5.7, 11.4 or 18.9 L)
Motor	115 VAC, 60 Hz, 1ph or 230 VAC, 50/60 Hz, 3 ph
Instruction Manual	L12600



ORDERING OPTIONS

MINIATURE METER-FLO (MMF) MODELS

Part Number	Reservoir Capacity gallons (liters)	Flow Rate in ³ /min (cm ³ /min)	Maximum PSI (Bar)
-------------	--	--	----------------------

MINIATURE METER-FLO (MMF) 115 VAC PUMPS WITH RESERVOIRS

MM1112	1.5 (5.7)	1 (16.4)	1,500 (103)
MM1113*		1 (16.4)	1,500 (103)
MM1212		5 (82)	2,000 (138)
MM1412		14 (229)	1,500 (103)
MM2112	3 (11.4)	1 (16.4)	1,500 (103)
MM2212		5 (82)	2,000 (138)
MM2412		14 (229)	1,500 (103)
MM3212	5 (18.9)	5 (82)	2,000 (138)
MM3412		14 (229)	1,500 (103)

*Part Number MM1113 includes dual level switch (high/low) part number 26C344.

MMF PUMP AND MOTOR ASSEMBLIES, WITHOUT RESERVOIRS

Part Number	Description
564412	1 in ³ /min flow rate
564413	5 in ³ /min flow rate
564414	8 in ³ /min flow rate
564415	14 in ³ /min flow rate

ADDITIONAL MMF SPARE PARTS

Part Number	Description
557286	Motor, 115 VAC
557293	Gear box, 1 in ³ /min (12.5:1)
557822	Gear pump only, 1 to 8 in ³ /min
557821	Gear pump only, 14 in ³ /min
557810	Suction strainer
563558	Pressure relief valve
557825	Low level switch
26C344	High/low level switch

SOLID STATE TIMER KIT

Part Number	Description
563339	Includes timer 562872, plus mounting bracket to connect to MMF oil tanks.

METER-FLO® PUMP

CONTINUOUS DUTY DURABILITY

With its solid pump housing, these rugged gear pumps are designed for dependable operation in high demand applications. The gear pump is available with a direct-coupled 1/2 horsepower motor capable of 1,725 rpms with output volumes of 245 cubic inches per minute. Eleven different pump models to choose from.



Solid Pump Housing

Rugged and durable for dependable operation.

NPT or SAE Porting

Options for 1/2 in NPT or 7/8 in SAE O-Ring Boss.

Drive Shaft with Woodruff Key

1/2 in (12.7 mm) drive shaft mates to standard couplings.

Adjustable Pressure Relief Valve

Protects pump against overload conditions.

Standard SAE 4-bolt Mounting

Simplifies installation.

TYPICAL APPLICATIONS

- Ideal for applications requiring continuous oil delivery up to 1,000 lubrication points

TYPICAL FLUIDS

- Oil – 300 to 3,000 SUS

TECHNICAL SPECIFICATIONS

Output Volume Per Minute	14 to 245 in ³ (230 to 4,015 cm ³)
Maximum Output Pressure	300 to 1,500 psi (20.7 to 103.5 bar)
Operating Temperature	50°F to 150°F (10°C to 65.5°C)
Instruction Manual	L12611



ORDERING OPTIONS

METER-FLO PUMPS

Part Number		Rotation	Displacement	
Port Thread			in ³ (cm ³)/minute	
1/2 in NPT	7/8 in SAE		1,140 RPM	1,725 RPM
557813	-	CCW	18 (295)	30 (492)
557814	558953	CCW	9 (147)	14 (229)
557815	-	CCW	56 (918)	84 (1,377)
558949	-	CW	56 (918)	84 (1,377)
557816	-	CCW	76 (1,245)	117 (1,917)
558950	-	CW	76 (1,245)	117 (1,917)
557817	-	CCW	111 (1,819)	168 (2,753)
558951	-	CW	111 (1,819)	168 (2,753)
557818	558954	CCW	26 (426)	40 (655)
557819	-	CW	9 (147)	14 (229)
557820	-	CCW	161 (2,638)	245 (4,015)
558955	-	CW	161 (2,638)	245 (4,015)

Above displacements are nominal outputs at 600 psi (41 bar) using 350 SUS oil at 70°F (76 cSt @ 21°C).



CW = Clockwise rotation / CCW = Counter-clockwise rotation when facing pump shaft

METER-FLO PADDLE BASE AND PUMP PACKAGES



Include motor mounting base, pump, L-bracket, coupler, coupler guard, and other small hardware needed to mount a 56F motor. Simply add any 56F motor (or 56C with feet) to complete the pump package.

Part Number	Description
563557	Paddle base with pump 557814
564411	Paddle base with pump 557813

REPAIR KITS

	Part Number	Description
	557997	Meter-Flo seal kit
	557998	Meter-Flo relief valve repair kit

ADDITIONAL MOUNTING OPTIONS FOR METER-FLO PUMPS – pumps not included.

	Part Number	Description
	558956	Bell housing bracket and coupler kit – requires NEMA 56C motor with feet.
	561067	L-bracket – bare part for mounting Meter-Flo pump in a custom application

COMPACT DYNA-STAR®

RIGHT-SIZED SOLUTION

The Graco Compact Dyna-Star (CDS) automatic lubrication system delivers high-capacity flow, robust durability and innovative control in a smaller footprint to extend uptime for today's toughest earth-moving machines and users in the harshest environments.

Rugged Durability

Metal construction ensures trustworthy operation in the most extreme environments.

Integrated Auto-Fill Shut-Off

This option enables single-person, powered-down, ground-level refills, without the need to climb or worry about spills.

Smart Power Train

24 VDC, brushless motor and zero-maintenance gear drive deliver lubricants on time, even at -40° F (-40° C).

Compact Power

Fits easily in space-limited applications; powerful enough to keep up with aggressive lubrication interval.

Intelligent Monitoring

Optional pressure and lubricant level sensors provide useful system information in real time.



TYPICAL APPLICATIONS

- Aggregates
- Mining
- Construction
- Hydraulic Fracturing Units

TYPICAL FLUIDS

- Oil and Grease up to NLGI #2

TECHNICAL SPECIFICATIONS

Maximum Working Pressure	3,500 psi (241 bar)
Operating Temperature	-40° F to 149° F (-40° C to 65° C)
Reservoir Size	12 L, 20 L, or 60 lb (30 L) reservoir or 35 lb (20 L) pail option
Maximum Flow Output Rate	4.5 in ³ /min (74 cm ³ /min)
Certifications/Ratings	IP69K
Instruction Manual	3A6941

COMPACT DYNA-STAR®, GLC™ X CONTROLLER AND AUTO LUBE™ APP



ORDERING OPTIONS

CD - X - X - X - X

Pump Description

Code	Description
1	12 L / 35 lb bucket length, 24 VDC
2	20 L reservoir length, 24 VDC
3	60 lb (30 L) reservoir length, 24 VDC

Metering System Feedback

Code	Description
0	Series progressive, no vent-valve, no pressure feedback (plugged outlet)
1	Vent-valve, no pressure feedback (plugged outlet)
2	Vent-valve, pressure switch
3	Vent-valve, pressure-reporting transducer

Reservoir

Code	Description
0	No reservoir, bare pump
1	12 L steel reservoir, follower plate
2	20 L steel reservoir, follower plate
3	35 lb plastic bucket kit – cover, follower plate (bucket not included)
4	12 L steel reservoir, no follower plate
5	20 L steel reservoir, no follower plate
6	60 lb (30 L) steel reservoir, follower plate
7	60 lb (30 L) steel reservoir, no follower plate

Reservoir Accessories

Code	Description
0	Bare pump or bucket kit (no reservoir)
1	Low-level switch
2	Level-reporting transducer
3	Auto-fill shut-off and low-level switch
4	Auto-fill shut-off and level-reporting transducer

COMPACT DYNA-STAR ACCESSORIES

	Part Number	Description
	26A883	GLC X to CDS 3 ft (1 m) cable
	26A884	CDS extension cable, 12-wire, 20 ft (6 m) with flying leads
	26A889	12-pin DT female CDS mating connector kit
	25R001	12 liter reservoir wall mount bracket
	25R318	Mounting bracket for GLC X, Red Alert filter, 3- and 5-section MSP assemblies or 3- and 5-bank GCI and GL-1 series injectors



ELECTRIC PUMPS

PAIR WITH THE GLC® X CONTROLLER AND AUTO LUBE™ APP

The all-new Bluetooth®-enabled GLC X controller and Auto Lube app will offer easy programming and real-time data for a wide range of auto-lube systems, even competitors' pumps.



Easy-to-Read Screen

High-contrast screen features text codes, faults and other data clearly in any ambient light.

Real-Time System Reporting

Program and display a wide range of customizable functions.

Smart Device and Mobile App

With the Auto Lube app, monitor lubrication levels, configure settings, track history and share important diagnostics.



Part Number	Description
26A855	GLC X controller with 20 ft (6 m) cable
26A814	GLC X controller
26A882	GLC X wiring harness, 12-wire, 20 ft (6 m) with flying leads

ACCESSORIES

Part Number	Description
26A853	GLC X pump and sensor simulator
26A882	GLC X 20 ft (6 m) cable
26A883	GLC X to Compact Dyna-Star® 3 ft (1 m) cable
26A888	14-pin mating connector kit

ELECTRIC DYNA-STAR® HP AND DYNA-STAR HF

THE RUGGED WORKHORSE

The Graco Electric Dyna-Star (EDS) pumps are built on a heavy steel reservoir with common bolt pattern to easily replace older designs. The time-proven Graco Advantage Drive is combined with existing Graco barrel pump lowers to provide performance you can depend on.

Safely Move Pump

Built-in lift ring is rated to 500 lbs (226 kg).

M23 Connector

Saves installation time.

Adjustable Motor and Amp Control

Make adjustments with the turn of a dial. LED status lights.

Mechanical Auto-Fill Shut Off

Shuts off the fill pump for clean, trouble-free refilling without electronics.

Graco Advantage Drive™

Hardened steel gears are lubricated for life and sealed to keep contaminants out for longer-lasting performance.

Direct-Mount Electric Vent Valve

Compact design means fewer parts to break or wear out.

Low-Level Sensor

Alerts low grease status and self-clears without a follower plate.

Tube-in-Tube

Provides simple and direct venting and filling to the foot of the pump.

Strong 12-Gauge Steel Reservoir

Available in 60 lb (27 kg) or 90 lb (41 kg) reservoirs. Matches common bolt pattern.

Remote Fill Manifold

Enables clean and efficient ground-level filling up to 5,000 psi (344 bar).



TYPICAL APPLICATIONS

- Mining Operations
- Milling and Crushing
- Heavy-duty Construction
- Well Services
- Industrial (see part number 77X524 for AC to DC Converter)

TYPICAL FLUIDS

- Oil and Grease up to NLGI #2



TECHNICAL SPECIFICATIONS

	HF Models	HP Models
Max Output Volume Per Minute	1.5 to 35 in ³ /min (24.6 to 574 cm ³ /min)	1.5 to 18 in ³ /min (24.6 to 295 cm ³ /min)
Maximum Outlet Pressure	3,500 PSI (241 bar)	5,000 PSI (344 bar)
Certifications/Ratings	IP69K	
Inlet/Outlet Sizes		
Tank/Reservoir Fill Port	1/2 in NPT	
Overflow Port	1/2 in NPT	
Fluid Outlet Size	3/8 in NPT	
Operating Temperature	14°F to 149°F (-10°C to 65°C)	-40°F to 149°F (-40°C to 65°C)
Power	24 VDC	
Instruction Manual	332514	



ORDERING OPTIONS

STAND ALONE PUMPS

	Part Number	Description
	77X000	24 VDC HP stand-alone pump for 35 or 60 pound reservoir
	77X001	24 VDC HP stand-alone pump with tube-in-tube for 35 or 60 pound reservoir
	77X002	24 VDC HP stand-alone pump with tube-in-tube for 90 or 120 pound reservoir
	77X003	24 VDC HP stand-alone pump with tube-in-tube for 400 pound reservoir
	77X014	24 VDC HF stand-alone pump for 35 or 60 pound reservoir
	77X015	24 VDC HF stand-alone pump for 120 pound reservoir
	77X016	24 VDC HF stand-alone pump for 400 pound reservoir

HP PUMP MODULES

Reservoir Size		Vent Valve	Dip Stick	Low Level 77X522 (DIN)	Follower Plate	Low Level 17L372 (M12)	Auto-Fill Shut Off
60 lb (27 kg)	90 lb (41 kg)						
77X100	77X101	•	•				
77X104	77X105	•		•	•		
77X202	77X203	•				•	•
77X204	77X205	•				•	



ELECTRIC DYNA-STAR® HP AND DYNA-STAR HF

ORDERING OPTIONS



CUSTOM TANK INJECTOR KITS

Part Number	Description
77X011	24 VDC HP pump and vent valve with tube-in-tube for 35 or 60 pound reservoir
77X012	24 VDC HP pump and vent valve with tube-in-tube for 90 or 120 pound reservoir
77X013	24 VDC HP pump and vent valve with tube-in-tube for 400 pound reservoir

FOLLOWER PLATES AND COVERS

	Container Size				Description
	35 Pound Bucket	60/90 Pound Graco Reservoir	120 Pound Refinery Drum	400 Pound Refinery Drum	
	77X510	77X500	77X511	77X512	Follower plate for pumps with tube-in-tube
		247700	247701	247702	Follower plate for pumps without tube-in-tube
	77X513	-	77X514	77X515	Drum cover

ACCESSORIES







	Part Number	Description
	77X521	Auto-fill Shut Off (AFSO) – diaphragm, plate, valve, coupler and pipes. Can be used to add AFSO to an EDS module that shipped without it, or as replacement part(s) for existing AFSO modules.
	77X522	Low level kit sight glass, electric low level switch and cable (requires follower plate 77X500)
	77X523	400 micron inline filter, maximum 5,000 psi (344 bar) inlet pressure (replacement filter 77X541)

ELECTRIC DYNA-STAR® HP AND DYNA-STAR HF ACCESSORIES



ORDERING OPTIONS

ACCESSORIES

	Part Number	Description
	17L366	Red alert filter with 380µm, 36 in² steel mesh filter (replacement filter 129031)
	24R952	Red alert filter with reservoir mounting kit (includes 17L366)
	16V678	Red alert filter mounting bracket
	77X524	110-230 VAC to 24 VDC converter box
Image Coming Soon	77X540	24 VDC electric vent valve with pressure relief
	77X542	Remote-fill manifold with vent
Image Coming Soon	77X543	HF output manifold with 4,000 psi pressure relief
	77X544	HP output manifold with 5,000 psi pressure relief
Image Coming Soon	77X545	Power cable for series progressive systems (pumps without a Vent Valve), M23 connector, 15 ft (4.6 m)
Image Coming Soon	77X546	Power cable for injector systems (pumps with a Vent Valve), M23 connector, 15 ft (4.6 m)
	115124	Pressure switch – pressure adjustment visible in window
	24N181	Pressure switch, 1/4 in NPT(F) inlet, DIN 43650 connector (1 NO/1 NC), 7,250 psi (500 bar)

ELECTRIC DYNA-STAR® XT

AN ELECTRIC ALTERNATIVE TO PNEUMATIC GREASE PUMPS

Electrify your lubrication system with Dyna-Star XT, an electric lubrication pump with XT Motor technology. Designed for heavy-duty mining equipment and industrial applications, Dyna-Star XT offers a drop-in upgrade for pneumatic grease pumps.

Electrifies the Lubrication System – No Air Supply Needed

- Eliminates issues related to dirty air, icing or inconsistent output

XT Motor Technology Leads to Extended Life and Optimized Output

- Increased Torque: Up to 15x more torque than conventional motors
- Consistent flow rate regardless of back pressure
- Quieter performance provides a more comfortable working environment

Seamless Drop-In Upgrades for Existing Systems

Higher Long-Term ROI

- Increased ease-of-repair compared to competitive pneumatic pumps in this size class



TYPICAL APPLICATIONS

- Heavy-duty mining equipment
- Industrial applications

TECHNICAL SPECIFICATIONS

Stroke	4.75 in (121 mm)
Operating Temperature	14°F to 104°F (-10°C to 40°C)
Control Options	PLC or GLC 4400 AC (Part #24B596 series "K" or later)
Max Working Pressure	7,000 psi (48.3 MPa, 483 bar)
Pump Output	2.1 in ³ (34.4 cm ³) / per cycle
Max Cycle Rate	30 cycles per minute
Pump Outlet	3/4 in NPT
Protection Grade	IP66, Type 4X
Electrical Ratings	100-120 V, Single Phase, 50/60 Hz, 12 A
Instruction Manual	X021555

ORDERING OPTIONS

DYNA-STAR XT PUMP

Part Number	Description
2009845	Dyna-Star XT Pump

DYNA-STAR XT PUMP ACCESSORIES

Part Number	Description
2010688	Motor Assembly Kit
2010555	Complete Pump Lower Assembly Kit
2009432	Pump Lower Seal Kit
2011184	Rotor Kit
2011185	Stator Cap Kit
2011186	Complete Rotor Repair Kit
2011187	Control Board Kit
25U200	Follower Plate – 400 lb (180 kg) Barrel
25U202	Drum Cover – 400 lb (180 kg) Barrel
2007333	Pump Flange Mounting Kit



MANZEL® MBL BOX LUBRICATORS

FORCE FEED BOX LUBRICATORS

The Manzel Modular Box Lubricator (MBL) provides true modularity that permits customizing a pump-to-point lubrication system from off-shelf components. MBL pumping packages can also be used with MHH divider valves in a series progressive system. Each moving part is lubricated at all times by the fluid in the reservoir. This and the wide range of options, high discharge pressure and rugged construction make the MBL ideally suited for a wide variety of industries and applications.

GBL 7500 Pumps

Modern design that has become the industry standard. See page 54 for pump part numbers.

Suction Pumps Installed

- Use ordering menu on page 55 to specify pumps to be installed.
- Gravity and Pressure Feed pumps are sold separately for field installation.

Modular Drive

External drive assemblies available as replacement parts.



Heater Port

Integrated 1 in NPT port makes optional electric heater installation simple.

Heavy Steel Reservoirs and Mounting Bases

Eight reservoir capacities are available to hold up to 40 pints and 24 pumps.

TYPICAL APPLICATIONS

- Compressors – petrochemical, refineries, gas transmission and more
- Edgers, planers and band saws
- Rubber mixers
- Cannery lid presses

TYPICAL FLUIDS

- Mineral oil or synthetic based lubricants
- 80 to 5,000 SUS

TECHNICAL SPECIFICATIONS

Maximum Pressure	7,500 psi (517 bar)
Power	115/230 VAC, 230/460 VAC, 60 Hz
Operating Temperature	-20°F to 140°F (-29°C to 60°C)
Reservoir Size	See the following pages
Maximum Run Time	Continuous
Output per Element/Min	0.7, 1.2, or 2.7 in ³ (11.45, 19.65, or 44.25 cm ³)
Certifications/Standards	ATEX (depends on configuration)
Instruction Manual	3A2100

ELECTRIC PUMPS

MANZEL® MBL BOX LUBRICATORS

MANZEL® MBL PUMP/RESERVOIR COMBINATIONS WITH MOTOR MOUNTING BASES

NOTE: All part numbers on the chart below use "0A" (Zero-A) to indicate assemblies with NO pumps. Refer to Smart Code ordering details.

END ROTARY DRIVES

Add GBL 7500 pumps and a NEMA 56F motor, or 56C with feet, to complete the assembly – see motor options on page 60.

Drive Ratio	Reservoir Size				
	4 pint (1.9 L)/ 2 Feed	6 pint (2.8 L)/ 3 Feed	8 pint (3.8 L)/ 5 Feed	12 pint (5.7 L)/ 8 Feed	16 pint (7.6 L)/ 12 Feed
50:1	MBJ0AK	MBK0AK	MBL0AK	MBM0AK	MBN0AK
100:1	MBJ0AL	MBK0AL	MBL0AL	MBM0AL	MBN0AL
200:1	MBJ0AM	MBK0AM	MBL0AM	MBM0AM	MBN0AM
400:1	MBJ0AN	MBK0AN	MBL0AN	MBM0AN	MBN0AN
Replacement Camshaft	564166	564167	564170	560381	564179

HEAVY DUTY GEARBOX DRIVES

Add GBL 7500 pumps and a NEMA 56C motor to complete the assembly – see motor options on page 60.

Drive Ratio	Reservoir Size		
	24 pint (11 L)/ 16 Feed	32 pint (15 L)/ 20 Feed	40 pint (19 L)/ 24 Feed
400:1	MBP0AY	MBR0AY	MBS0AY
Replacement Camshaft	564166	564167	564170

MBL REPLACEMENT PARTS

Part Number	Description
25T989	Cam replacement kit – includes cam, key, and set screw for one pump station. For replacement cam shafts, see tables above.

REPLACEMENT GEARBOXES

Drive Letter from Ordering Menu	Drive Ratio	Spare Part Number	Compatible with Reservoir/Base J – N?
J	25:1	564055	No*
K	50:1	564054	Yes
L	100:1	563121	Yes
M	200:1	563122	Yes
N	400:1	563120	Yes

*25:1 ratio is too low for use with 1,725 rpm motor.

Drive Letter from Ordering Menu	Drive Ratio	Spare Part Number
Y	400:1	557162



ORDERING OPTIONS

MBL Smart Code Ordering Menu

MB - X - X - X - X

Reservoir (Smart Code Option A)

Code	Former Code(s)	Description	Code	Former Code(s)	Description
A	T1	4 pt (1.9 L), 2 pump stations max	J	T1 and P1	4 pt, 2 pump stations max, motor mount base
B	T2	6 pt (2.8 L), 3 pump stations max	K	T2 and P2	6 pt, 3 pump stations max, motor mount base
C	T3	8 pt (3.8 L), 5 pump stations max	L	T3 and P3	8 pt, 5 pump stations max, motor mount base
D	T4	12 pt (5.7 L), 8 pump stations max	M	T4 and P4	12 pt, 8 pump stations max, motor mount base
E	T5	16 pt (7.6 L), 12 pump stations max	N	T5 and P5	16 pt, 12 pump stations max, motor mount base
F	T6	24 pt (11.4 L), 16 pump stations max	P	T6 and P6	24 pt, 16 pump stations max, motor mount base*
G	T7	32 pt (15.1 L), 20 pump stations max	R	T7 and P7	32 pt, 20 pump stations max, motor mount base*
H	T8	40 pt (18.9 L), 24 pump stations max	S	T8 and P8	40 pt, 24 pump stations max, motor mount base*

*Cannot use double reduction or right angle drives.

Pump Size – GBL 7500 Suction Pumps (Smart Code Option B)

Code	Former Code(s)	Description
0	00	No pumps
1	76/88B	3/16 in Suction Pump 24J391
2	76/88C	1/4 in Suction Pump 24J392
3	76/88E	3/8 in Suction Pump 24J393
4	76/88B and F3	3/16 in Suction Pump plus RENS Level Controller
5	76/88C and F3	1/4 in Suction Pump plus RENS Level Controller
6	76/88E and F3	3/8 in Suction Pump plus RENS Level Controller

NOTES:

1. When pump quantity is less than maximum pump stations of specified reservoir, a blank cover assembly is installed at Graco.
2. When low level is specified, deduct one pump for each option.
3. When ordering a ratchet drive, the maximum number of pumps allowable is 20.

Pump Quantity (Smart Code Option C)

Code	Qty	Code	Qty	Code	Qty	Code	Qty	Code	Qty	Code	Qty
A	0	E	4	J	8	N	12	T	16	X	20
B	1	F	5	K	9	P	13	U	17	Y	21
C	2	G	6	L	10	R	14	V	18	Z	22
D	3	H	7	M	11	S	15	W	19		

Drive Options (Smart Code Option D)

Code	Former Code	Description	Code	Former Code	Description
A	G01R	Direct End Rotary (50 rpm max)	H	G04L	End Rotary Ratchet 75:1 – max input of 800 RPM
B	G02R	End Ratchet (without drive arm 563005)	J	G05R	Double Reduction End Rotary 25:1
C	G03R	End Rotary Ratchet 37-1/2:1 – max input of 800 RPM	K	G06R	Double Reduction End Rotary 50:1
D	G04R	End Rotary Ratchet 75:1 – max input of 800 RPM	L	G07R	Double Reduction End Rotary 100:1
E	G01L	Direct End Rotary	M	G08R	Double Reduction End Rotary 200:1
F	G02L	End Ratchet (without drive arm 563005)	N	G09R	Double Reduction End Rotary 400:1
G	G03L	End Rotary Ratchet 37-1/2:1 – max input of 800 RPM	Y	G18R	400:1 Ratio Gear Reducer**

**Y (G18) requires motor mounting base; can only be used with reservoir options P, R and S.

MANZEL® MBL BOX LUBRICATORS

ORDERING OPTIONS

MBL BOX LUBRICATOR MOTORS

	Part Number	Description
	558289	M2 – 1/4 hp, 1,725 rpm, 115/230V, 1 ph., TENV, Foot-Mounted (56F)
Image Coming Soon	558293	M3 – 1/4 hp, 1,725 rpm, 115/230V, 1 ph., Hazardous Area, Class 1, Group D, Foot-Mounted (56F)
	558290	M5 – 1/4 hp, 1,725 rpm, 230/460V, 3 ph., TENV, Foot-Mounted (56F)
Image Coming Soon	558292	M6 – 1/4 hp, 1,725 rpm, 230/460V, 3 ph., Hazardous Area, Class 1, Group D, Foot-Mounted (56F)
	558294	M7 – 1/2 hp, 1,725 rpm, 115/230V, 1 ph., Hazardous Area, Class 1, Group C, Severe Duty, Tropical Insulation, Face-Mounted or Foot-mounted (56C with feet)
Image Coming Soon	558291	M10 – 1/2 hp, 1,725 rpm, 230/460V, 3 ph., 60Hz, Class 1, Group D, Face-Mounted (56C)
	557271	M11 – 1/2 hp, 1,725 rpm, 115/230V, 1 ph., 60Hz, TEFC, Face-Mounted (56C)
	557270	M12 – 1/2 hp, 1,725 rpm, 230/460V, 3 ph., 60Hz, TEFC, Face-Mounted (56C)

NOTE: Heavy Duty drive "Y" (G18R) requires 56C, face-mount. Normally a 1/2 hp motor would be used because more pumps are being operated by the HD drives.

ELECTRIC PUMPS



ORDERING OPTIONS

AUTO FILL OPTIONS

	Part Number	Description
	559037	F1 Gravity Supply

NOTE: F2 – obsolete, use F1 instead. F3 – ordered with pumps (see page 55). F4 – ordered with pumps (see page 55).

LOW LEVEL SWITCHES

	Part Number	Description
	563013	L1 – Low Level Switch Hazardous Area. Class 1, Group C and D; Class 2 Group, E, F and G.
	564015	L2 – Low Level, 10 Watts at 120 VAC, SPST Reed Switch, NC

SHAFT ROTATION ALARM

	Part Number	Description
	24K466	GBL 7500 Shaft Rotation Alarm Pump

HEATER OPTIONS

Image Coming Soon	Part Number	Description
	557207	120 VAC Electric Heater, Hazardous Area, Class 1, Group B, one-prong heater. Can be installed in 1 in NPT port on MBL reservoirs.

NOTE: Former codes H3, H4 and H6 use 557207. For H1, H2 and H5, contact factory for details about part number 564058 (two prong heater) Class 1, Group D

DAY TANK OPTIONS

Modu-Flo oil tanks include 1/2 in NPSF female thread at the bottom of the tank to receive a 1/2 in NPT male fitting.

	Part Number	Description
	563319	12 pt Tank
	563320	24 pt Tank
	563321	40 pt Tank

PNEUMATIC PUMP SELECTION GUIDE

Pump Family	Typical Applications	Fluid Type	Maximum Output Pressure psi (bar)	Maximum Output Volume in ³ (cm ³)	Reservoir Capacity Options		Metering	Reference Page
					US	Metric - Liters		
 <p>LubePro™</p>	<ul style="list-style-type: none"> • Energy, Infrastructure and Heavy Equipment • In-Plant Manufacturing 	40 cSt oil minimum / grease up to NLGI #2	3,500 to 4,000 (241 to 276)	Single Stroke Pumps – 0.56 to 3.0 (9.2 to 49.2) per stroke Reciprocating Pumps – 50 (819) per minute	Oil – 1.3, 4.2, 5 or 12 pints Grease – 1, 4, 6 or 12 lbs	Oil – 0.6, 2.0, 2.4 or 5.5 Grease – 0.5, 2, 3 or 6	SLP	63-67
 <p>LubriSystem</p>	<ul style="list-style-type: none"> • In-Plant Manufacturing 	Oil/grease up to NLGI #1	1,350 (93)	1.5 (25) per stroke	Oil – 6, 12 or 20 pints Grease* – 3, 6 or 12 lbs	Oil – 2.8, 5.5 or 9 Grease – 1.5, 3, or 6	SLP	68-69
 <p>Modu-Flo®</p>	<ul style="list-style-type: none"> • Energy, Infrastructure and Heavy Equipment • In-Plant Manufacturing 	Oil/grease up to NLGI #2	3,000 (207)	0.030, 0.120 or 0.240 (0.5, 2.0 or 3.9) per stroke	Oil – 5, 6, 12, 20, 24 or 40 pints Grease* – 3, 6, or 12 lbs	Oil – 2.4, 2.8, 5.5, 9, 11 or 19 Grease – 1.5, 3, or 6	SPDV	70-74
 <p>E-Series</p>	<ul style="list-style-type: none"> • In-Plant Manufacturing • Vehicle service 	Oil up to 30,000 SUS / grease up to NLGI #2	2,000 (138)	0.030 (0.5) per stroke	Oil – 4 pints Grease* – 3 or 6 lbs	Oil – 1.9 Grease – 1.5 or 3	SPDV	75-76
 <p>MSA-10 and MSA-100</p>	<ul style="list-style-type: none"> • In-Plant Manufacturing 	Oil/grease up to NLGI #2	3,000 (207)	0.120 or 0.800 (2 or 13) per stroke	N/A	N/A	SPDV	77-78
 <p>Pneumatic Dyna-Star® Fire-Ball® 300 50:1</p>	<ul style="list-style-type: none"> • Energy, Infrastructure and Heavy Equipment • In-Plant Manufacturing 	Oil/grease up to NLGI #2	3,500 (241)	54 (85) per minute	60 or 90 lb	30 or 45	SPDV or SLP	79-80

*See page 73 for note on legacy Trabon grease reservoir volumes and metric conversions.



= Single Line Parallel (Injectors)



= Series Progressive Divider Valve



LUBEPRO™

FOR SIMPLE, INJECTOR-BASED AUTOMATIC LUBRICATION SYSTEMS

As a hard-working professional focused on ensuring your production lines keep moving and your operating costs are reduced, automatic lubrication should be an essential part of your machine maintenance. Without proper lubrication your equipment can suffer from downtime and reduced life, which impacts your company's bottom line. Avoid the hassle. Meet your LubePro.



PNEUMATIC PUMPS

TYPICAL FLUIDS

- 40 cSt oil minimum
- NLGI #000 to NLGI #2 grease

TYPICAL APPLICATIONS

- Packaging
- Food and Beverage Processing and Packaging
- Glass Manufacturing
- Tire Production
- Thermoforming
- Injection Molding
- Paper Production
- Labelers
- Automation Machinery
- Presses
- Steel Forging and Finishing
- Bearing Manufacturing

A4000 RECIPROCATING PUMP

Two Models Available

Oil or grease: 4,000 psi (276 bar).

Multiple Reservoir Types

- Oil without follower plate – 5.5 liter
- Grease with follower plate – 7.5 lbs / 13 lbs.

Simple Controlling

PLC or lube controller actuates a 3-way air valve to drive pump and vent valve to relieve pressure in the system once lube cycle is complete.

Easy to Install

Utilize existing mounting holes for easy replacement and installation.

Pneumatic Power

Easily installed into existing air line.

Vent Valve

Integrated pneumatic vent valve.

Fast Cycle Rate and Flow

Output of up to 50 in³/min (819 cc/min).

Low Level Detection

Available as a factory-installed option. Easy to connect, comes with field-wireable DIN connector; NO or NC.



17P751

TECHNICAL SPECIFICATIONS

Fluid Handling Capabilities	40 cSt oil - #2 grease
Maximum Working Pressure	4,000 psi (276 bar)
Pressure Ratio	40:1
Pump Output Per Minute	50 in ³ (819 cm ³)
Maximum Air Inlet Pressure	100 psi (6.89 bar)
Air Inlet Size	1/4 in NPT
Fluid Outlet Size	1/4 in NPT
Operating Temperature	14°F to 149°F (-10°C to 65°C)
Instruction Manual	3A5266

ORDERING OPTIONS

Fluid	Pressure Ratio	Reservoir Size	Part Number
Oil	40:1	12 pints (5.5 L)	17P753
Grease		6 lbs (3 L)	17P751
		12 lbs (6 L)	17U217



A2800 AND A2900 VERTICAL PUMPS

Self-Venting Pump

Integrated vent automatically relieves pressure on return stroke, no pressure switch or wiring required.

High-Strength, Shatter-Resistant Reservoir

Utilizes a high-quality, polycarbonate reservoir.

Simple Controlling

PLC or Lube controller actuates a 3-way air valve to drive pump, and vent on the return stroke.

Fast Cycle Rate and Flow

Cycles and vents lubricant injectors in as little as 10 seconds. 0.56 in³ of oil per stroke and 0.58 in³ of grease per stroke.

Multiple Reservoir Types

- Oil without follower plate – 0.6 and 2 liter.
- Grease with follower plate – 1 and 4 lb.

Easy to Install

Utilize existing mounting holes for easy replacement and installation.

Low Level Detection

Reliable, Graco factory-installed low level indicator that is easy to connect using a simple DIN connection.



Pneumatic Power

Easily installed into existing air line.

TECHNICAL SPECIFICATIONS

	A2800	A2900
Fluid Handling Capabilities	40 cSt oil minimum	Up to #2 grease
Maximum Working Pressure	3,500 psi (241 bar)	
Pressure Ratio	28:1	29:1
Pump Output Per Stroke	0.56 in ³ (9.18 cm ³)	0.58 in ³ (9.5 cm ³)
Maximum Air Inlet Pressure	175 psi (12.1 bar)	
Air Inlet Size	1/4 in NPT	
Fluid Outlet Size	1/4 in NPT	
Operating Temperature	14°F to 149°F (-10°C to 65°C)	
Instruction Manual	3A4033	3A4096

ORDERING OPTIONS

Pump Model	Fluid	Pressure Ratio	Reservoir Size	Pump Without Low Level	Pump With Low Level
A2800	Oil	28:1	0.6 liters	-	24Z021 (NO)
					24Z022 (NC)
			2 liters	24Z026	24Z027 (NO)
					24Z028 (NC)
A2900	Grease	29:1	1 lb	-	24Z052 (NO)
					24Z053 (NC)
			4 lb	24Z057	24Z058 (NO)
					24Z059 (NC)



H1900, A1900 AND A2600 HORIZONTAL PUMPS

Two Reservoir Types

2 liter reservoir available in grease or oil. Select from the 19:1 oil pump or the 26:1 grease pump.

High-Strength, Shatter-Resistant Reservoir

Utilizes a high-quality, polycarbonate reservoir that is securely mounted to the pump with rigid tie rods for optimal sealing.

Easy to Install

Utilize existing mounting holes for easy replacement and installation.

Fire-Ball® Pump Casting

Leverages the proven quality and long life of Graco's Fire-Ball pump. Eliminates tie rods and end cap.

Pneumatic Power

Easily installed into existing air line.

Fast Cycle Rate and Flow

Cycles and vents lubricant injectors in as little as 10 seconds. 2.2 in³ of grease per stroke and 3.0 in³ of oil per stroke.

Self-Venting Pump

Integrated vent automatically and reliably relieves pressure on return stroke, no pressure switch or wiring required.

No Priming Required

No need to bleed the valve to prime the pump, no priming is required.

Low Level Detection Option

Reliable, Graco factory-installed low level indicator that is easy to connect using a simple DIN connection.



TECHNICAL SPECIFICATIONS

	H1900	A1900	A2600
Fluid Handling Capabilities	40 cSt oil minimum	40 cSt oil minimum	Up to #2 grease
Maximum Working Pressure	3,500 psi (241 bar)		
Pressure Ratio	19:1	19:1	26:1
Pump Output Per Stroke	3.0 in ³ (49.16 cm ³)	3.0 in ³ (49.16 cm ³)	2.2 in ³ (36.05 cm ³)
Maximum Air Inlet Pressure	185 psi (12.8 bar)	185 psi (12.8 bar)	135 psi (9.3 bar)
Air Inlet Size	1/4 in NPT		
Fluid Outlet Size	3/4 in NPT		
Operating Temperature	14°F to 149°F (-10°C to 65°C)		

ORDERING OPTIONS

Pump Model	Fluid	Pressure Ratio	Reservoir Size	NPT		BSPB
				Pump Without Low Level	Pump With Low Level	Pump With Low Level
H1900	Oil	19:1	–	24Y498	–	–
A1900	Oil	19:1	2 liters	–	17C752	18C752
A2600	Grease	26:1	4 lb	–	17C751	18C751









LUBEPRO™ ACCESSORIES

ORDERING OPTIONS

LUBEPRO ACCESSORIES

	Part Number	Description	Maximum Working Pressure	Pump Compatibility					
				A1900	H1900	A2600	A2800	A2900	A4000
	105474	3-way air valve, 150 psi (10 bar), 1/2 NPSM(F) conduit ports for wiring, 1/4 NPT(F) air ports. 24 VDC/120 VAC	150 psi (10.3 bar)				•	•	•
	128305	4-way air valve, 12 VDC		•	•	•			
	128254	4-way air valve, 24 VDC		•	•	•			
	128255	4-way air valve, 120 VAC		•	•	•			
	128257	4-way air valve, 240 VAC		•	•	•			
	560734	Air valve reservoir mounting bracket			•				
	121474	Female coupler. Quick-disconnect. 1/4 in NPT. Mates with fill stud on LubePro grease pumps.	3,700 psi (255 bar)	•	•	•	•	•	•

PNEUMATIC PUMPS

LUBRISYSTEM

AIR OPERATED PUMP FOR SINGLE LINE PARALLEL SYSTEMS

Easy to design, modify and adjust for oil or grease applications. Combine with LubriSystem/Grease Jockey injectors or Injecto-Flo piston distributors for easy, low cost system design solutions. Efficient design promotes increased productivity and less downtime. Offers several reservoir choices for both oil and grease applications

PNEUMATIC PUMPS



Standard Low Level Switch Options

Uses the same switch kits as many other Trabon® pumps, with options for oil and grease.

Options For Oil And Grease

- Grease reservoirs include follower plate and spring for up to NLGI #1 grease.
- Oil reservoirs are also available in 6, 12, and 20 pint.

Rugged Polycarbonate Reservoir

The "plastic" reservoir options utilize a polycarbonate tube or convert to a steel reservoir for an even tougher material.

Self-Venting Pump

Integrated vent automatically relieves pressure on return stroke, no pressure switch or wiring required.

Trabon® Fill Stud

Uses mating coupler that is common to other Trabon pump packages.

9:1 Pump Ratio

Same reliable design as the classic Grease Jockey and A900 pumps, but with more reservoir options for added flexibility.

TYPICAL APPLICATIONS

- In-plant equipment and machinery

TYPICAL FLUIDS

- Oil and grease up to NLGI #1

TECHNICAL SPECIFICATIONS

Output per Stroke	1.5 in ³ (24.6 cm ³)
Maximum Output Pressure	360 to 1,350 psi (25 to 93 bar)
Air Inlet Pressure	40 to 150 psi (3 to 10 bar)
Ratio	9:1
Reservoir Material	Plastic (polycarbonate)
Instruction Manual	L12100



ORDERING OPTIONS

LUBRISYSTEM PUMP PACKAGES

Low Level Option		Reservoir Size	Replacement Reservoir	Low Level Switch
Included	Not Included			

GREASE PACKAGES

563572	563571	6 lb	562907	563322
563573	–	12 lb	562896	

OIL PACKAGES

563577	563574	6 pt	–	563014
563578	563575	12 pt	562892	563015
–	563576	20 pt	562893	563016

For a metal reservoir, refer to Lube Master section and select from those four options, then combine with bare pump 563579.

BARE PUMP

Part Number	Repair Kit	Description
563579	563762	Pump includes Trabon fill stud and hardware to receive reservoir.

AIR SOLENOID VALVES

150 psi maximum pressure, 1/4 in NPT female inlet.

Voltage		Air Outlet	Valve Ways	Air Motor Action
24 VDC	120 VAC			
563332	563315	1/4 in NPSF male banjo	3-way	Single

MODU-FLO®

TRUE MODULARITY

Wide choice of standard modular components helps you meet application requirements more exactly without the added cost of a custom system. A complete Modu-Flo modular pumping package (MPP) includes a pump, a baseplate manifold, a reservoir, and a variety of optional accessories. For more details search for brochure L12000 on Graco.com.

PNEUMATIC PUMPS

Fill Cap and Strainer

Included with every oil reservoir.

Low Level Switch

Options available for both oil and grease reservoirs.

High-Pressure Blowout Switch

Options for most oil and grease reservoirs; sold as a kit.

Polycarbonate (Plastic) and Metal Reservoir Options

For oil or for grease, a total of 16 options are available (see page 73).

Baseplate Manifold Kit

- All plumbing connects to the manifold.
- Option for use with NPT or BSP fittings.
- Flapper valve inside works with modular pump design to allow removal and replacement of pump without draining lubricant from the reservoir.

Modular Pump Design

- With options for pneumatic or hydraulic (page 82), a total of six models are available.
- Pneumatic pumps may have single or double action on their air motors, depending on which air solenoid is used to actuate the air motor.

TYPICAL APPLICATIONS

- In-plant
- Presses
- Mixers

TYPICAL FLUIDS

- Oil and grease up to NLGI #2

TECHNICAL SPECIFICATIONS

Output per Stroke	0.010 to 0.240 in ³ (0.164 to 3.933 cm ³)
Air Motor Action	Single or Double
Lube Piston Action	Single
Pump Ratio	30:1
Instruction Manual	332042



STEPS TO BUILD YOUR MODU-FLO SYSTEM:

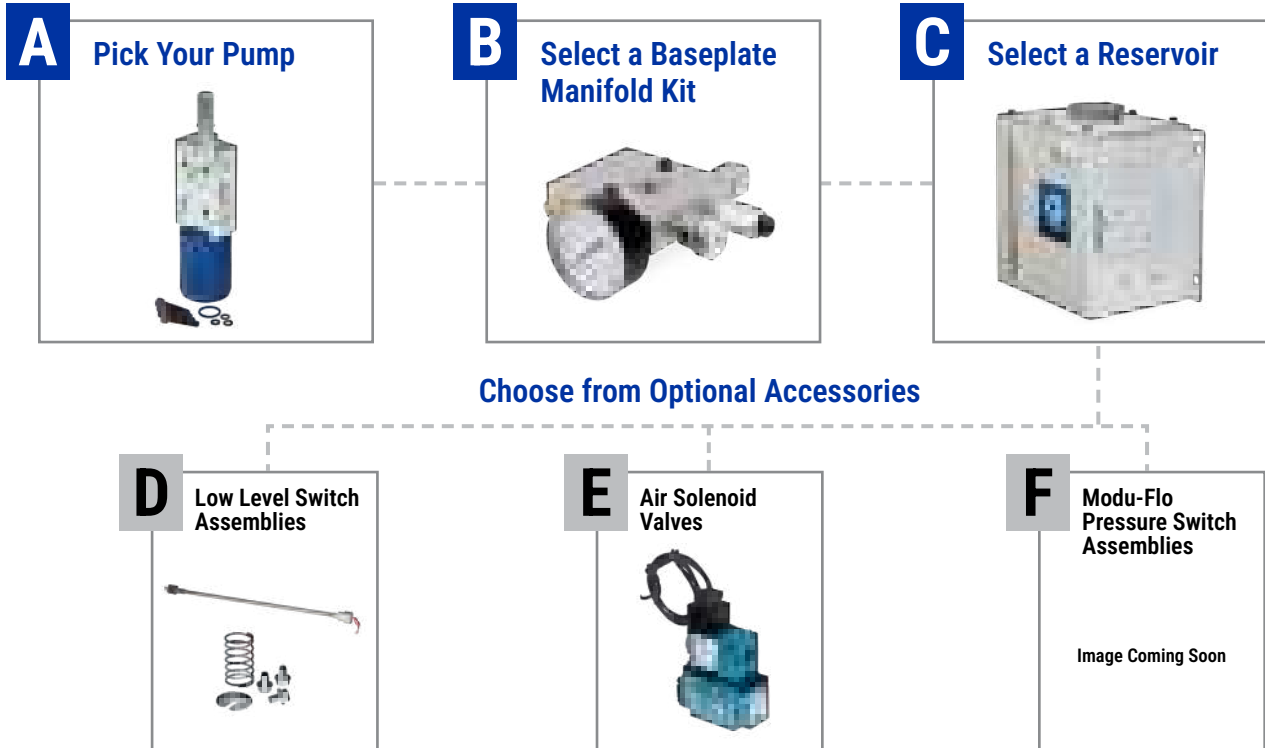

ORDERING OPTIONS

MODU-FLO PNEUMATIC PUMPS

	Pump Part Number	Model	Pump Output Range per Stroke in ³ (cm ³)	Air Motor Action	Maximum Cycles per Minute		Input Air Pressure Range PSI (bar)		Maximum Fluid Outlet Pressure PSI (bar)	Repair Kit Part Number
					Oil	Grease	Minimum	Maximum		
	563304	AL-5M	0.010 to 0.030 (0.164 to 0.492)	Single	30	10	40 (2.76)	150 (10.3)	3,000 (207)	563902
				Double*	60					
	563306	AL-25M	0.030 to 0.120 (0.492 to 1.966)	Single	30					563903
				Double*	60					
	563308	AL-50M	0.060 to 0.240 (0.983 to 3.933)	Single	30					563904
				Double*	60					

*Double acting air motors require a 4-way air solenoid to create the "double action." Single acting use a 3-way air solenoid and rely on spring return.

Complete your Modu-Flo pump package with a Baseplate Manifold, Reservoir and Accessories from the next page or refer to bulletin L12000. When replacing an older pump such as ALS-3A, ALJ-25C, etc., refer to the "Remote" Pump Manifold options to allow wall-mounting of the new pump instead of mounting directly to bottom of a reservoir.

MODU-FLO®

A ORDERING OPTIONS

PICK YOUR MODU-FLO PUMP

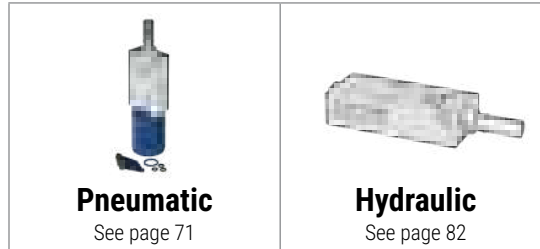

B ORDERING OPTIONS

BASEPLATE MANIFOLD KITS

Note: 563324 and 563331 are the most popular kits.

	Part Number	Thread	Mount	Outlet Check Valve	System Fill Check Valve	1,450 psi Blowout Assembly	0-3,000 psi Gauge
	563329	NPSF (NPT)	Reservoir	No	No	None	None
	563324	NPSF (NPT)	Reservoir	Yes	Yes	Standard	Dry
	563331	NPSF (NPT)	Reservoir	Yes	Yes	Tubed**	Dry
	563333	NPSF (NPT)	Reservoir	Yes	Yes	Tubed**	Liquid-filled
	563323	NPSF (NPT)	Wall/Remote*	Yes	Yes	Standard	None
	563330	NPSF (NPT)	Wall/Remote*	Yes	Yes	Tubed**	None

*Manifolds are intended for gravity feed (oil) or spring loaded follower feed (grease) only; not for use with header systems. **Includes 1/8 in NPT female spud.



C ORDERING OPTIONS

SELECT A RESERVOIR

Modu-Flo reservoirs include a built-in mounting bracket, and also a Pump Mounting Pad at the bottom of the reservoir. The pump mounting pad receives the "Reservoir" mount manifolds above (as well as several other pumps). The pad also includes a port with 1/2 in NPSF female thread to receive either an NPT or NPTF male fitting and then can then be used to gravity-feed a remote pump.

Part Number	Material	Capacity*	Tube and Gasket Replacement Kit
-------------	----------	-----------	---------------------------------

CYLINDRICAL GREASE RESERVOIRS

562911	Plastic (Polycarbonate)	3 pound	-
562888		5 pound	562901
562905		6 pound	562909
562884		12 pound	562902
562885		20 pound	562903
562906	Metal	6 pound	-
562886		12 pound	-
562887		20 pound	-

CYLINDRICAL OIL RESERVOIRS

562891	Plastic (Polycarbonate)	5 pint (2.4 L)	562901
562904		6 pint (2.8 L)	562909
562889		12 pint (5.7 L)	562902
562890		20 pint (9.5 L)	562903

RECTANGULAR OIL TANKS

563319	Metal	12 pint (5.7 L)	563934 oil level sight glass kit
563320		24 pint (11.4 L)	
563321		40 pint (18.9 L)	

*Nominal grease reservoir size is based on a direct conversion of oil reservoir capacity and does not reflect volume loss due to the follower and spring. Actual volumes contained are:

Nominal Size	Actual Volume
3 lb	3 lb (1.5 L)
5 lb	
6 lb	
12 lb	6 lb (3 L)
20 lb	12 lb (6 L)

D ORDERING OPTIONS

LOW LEVEL SWITCH ASSEMBLIES

FOR GREASE RESERVOIRS

3 lb	5, 6, 12 and 20 lb	Replacement Switch	Description
563272	563322	557781	SPDT switch and bracket kit installs to existing components included with grease reservoirs

FOR OIL RESERVOIRS

Cylindrical			Rectangular Metal Tanks	Replacement Switch	Description
5 and 12 Pint	20 Pint	6 Pint			
563015	563016	563014	563014	557825	"Low Watt" SPST switch assembly, used for most oils
563316	563317	563318	563318	557551	SPDT switch, older style preferred for heavy, stringy oils
-	-	-	564322	557825	Dual SPST, Low Watt Switches (One Low Level, One Shutdown)

MODU-FLO®

E ORDERING OPTIONS

AIR SOLENOID VALVES

150 PSI maximum pressure, 1/4 in NPT female inlet.

Voltage			Air Outlet	Valve Ways	Air Motor Action	Valve Mounting
24 VDC	120 VAC	240 VAC				
563332	563315	–	1/4 in NPSF male banjo	3-way	Single	Baseplate Manifold
128254	128255	128257	1/4 in NPT female	4-way	Double	Wall

F ORDERING OPTIONS

MODU-FLO PRESSURE SWITCH ASSEMBLIES

For Cylindrical Reservoirs		For Rectangular Metal Tanks	Replacement Switch	Description
5 Pint/Pound	6, 12 and 20 Pint/Pound			
563325*	563326*	563327	557781	High Pressure Blowout Switch Kit, requires approximately 3 ft of 1/4 in OD copper tubing, not included
563328*			557829	Kit includes Tee fitting for mounting to outlet port.

*Kits include yellow disks for use in oil systems. For grease systems replace the yellow disk with a red or an orange disk, depending on pressure rating of your mainline grease hose/tubing.

SPARE OR REPLACEMENT BLOWOUT DISKS

For pressure relief.

psi (bar)	Color Code	Part Number	
		Single	6-Pack
1,450 (99.9)	Yellow	557433	563962
1,750 (120.7)	Red	557434	563963
2,050 (141.4)	Orange	557435	563964
2,350 (162.0)	Aluminum	557436	563965
2,650 (182.6)	Pink	557437	–
2,950 (203.0)	Blue	557438	563966
3,250 (220.1)	Purple	557439	–

*Disks up to 2,350 psi have a tolerance of ± 500 psi. Disks greater than 2,350 psi have a tolerance of ± 20%.

MORE SPARE PARTS FOR MODU-FLO PACKAGES

Part Number	Description
563337	Pump mounting kit, includes four mounting screws, one large O-ring and three small O-rings to connect any Modu-Flo pump to bottom of baseplate manifold. Kit is included with new pumps, sold here as a spare part.

NPT Part Number	SAE-ORB Part Number	Description
563207	563053	Outlet Check Valve
563211	563056	System Fill Check Valve
563179	563180	Standard Blowout Assembly (1,450 psi / 100 bar)
563186	N/A	Tubed Blowout Assembly (1,450 psi / 100 bar)
557864	N/A	Standard (Dry) Pressure Gauge, 0-3,000 psi/0-210 bar dual scale, center back mount.
557866	557280	Liquid-Filled Pressure Gauge, 0-3,000 psi/0-210 bar dual scale, center back mount (557280 is PSI scale only).



E-SERIES

DESIGNED FOR RELIABILITY

The E-Series pump is a minimum cost, entry level alternative to standard pneumatic pump products. This all-in-one pump package comes complete with no assembly required and is easy to install. All pump packages include high-pressure rupture disk assembly and lube outlet check valve. The E-Series offers many reservoir options for either grease or oil. Great for any application where price is a concern and installation time is at a premium.



Modu-Flo Reservoirs

Provides easy interchangeability plus compatibility to most Modu-Flo accessories.

Standard Low Level Switch Options

Uses the same switch kits as many other Trabon® pumps.

Simple Operation

Each stroke of the fixed output pump supplies 0.030 in³ (0.491 cm³).

Drain Valve

Included petcock acts as a grease drain before removing a pump, and an air bleed during initial filling.

TYPICAL APPLICATIONS

- Presses and other in-plant machines

TYPICAL FLUIDS

- Oil up to 30,000 SUS
- Grease up to NLGI #2

TECHNICAL SPECIFICATIONS

Output per Stroke	0.030 in ³ (0.492 cm ³)
Maximum Output Pressure	2,000 psi (138 bar)
Ratio	20:1
Reservoir Material	Plastic
Air Pressure	40 to 150 psi (2.8 to 10.3 bar)
Cycle Rate	10 CPM grease, 30 CPM oil
Instruction Manual	L13126

E-SERIES

ORDERING OPTIONS

E-SERIES GREASE PUMP PACKAGES

Low Level Option		Reservoir Size	Relief Valve psi (bar)	Low Level Switch
Included	Not Included			
-	563365	3 lb	2,000 (138)	563272
563364	-	6 lb	2,350 (162)	563322

E-SERIES BARE PUMP

Part Number	Pump Output	Pump Output per Stroke in ³ (cm ³)	Relief Valve psi (bar)	Repair Kit
563358	Fixed	0.030 (0.492)	1,750 (121)	563909

AIR SOLENOID VALVES

150 psi maximum pressure, 1/4 in NPT female inlet

Voltage		Air Outlet	Valve Ways	Air Motor Action
24 VDC	120 VAC			
563332	563315	1/4 in NPSF male banjo	3-way	Single

To create your own custom pump package, combine 563358 with any Modu-Flo reservoir listed on page 73.



MSA-10 AND MSA-100

DURABLE IN-LINE PUMPS

MSA Series pumps are used together with main lubrication supply lines where the pump is fed directly from a bulk header system. MSA pumps can also be piped to Modu-Flo reservoirs. Use the MSA-10 for standard applications and the MSA-100 when larger outputs are required.



PNEUMATIC PUMPS

TYPICAL APPLICATIONS

- Presses and other in-plant machines and processing equipment

TYPICAL FLUIDS

- Oil and grease up to NLGI #2



TECHNICAL SPECIFICATIONS

	MSA-10	MSA-100
Material	Steel	Aluminum
Output per Stroke	0.04 to .120 in ³ (0.66 to 1.97 cm ³)	0.4 to 0.8 in ³ (6.57 to 13.11 cm ³)
Maximum Pump Strokes per Minute	Single-Acting – 15 Double-Acting – 60	Single-Acting – 15 Double-Acting – 30
Maximum Output Pressure	3,000 psi (207 bar)	
Air Pressure	40 to 150 psi (2.8 to 10.3 bar)	60 to 140 psi (4.1 to 9.7 bar)
Maximum Lube Inlet Pressure	500 psi (34 bar)	
Pump Ratio	25:1	
Instruction Manual	L12850	L12851

MSA-10 AND MSA-100

ORDERING OPTIONS

MSA PUMPS

	Part Number	Description
	562854	MSA-10 Air Operated Pump
	562855	MSA-100 Air Operated Pump

MSA KITS

	Part Number	Description
	563912	MSA-10 Repair Parts Kit
	563913	MSA-100 Repair Parts Kit

RESTRICTOR VALVE

	Part Number	Description
	563072	Slows the power stroke of the pump while allowing full speed on the return stroke.

RELIEF ASSEMBLY REPLACEMENT PARTS

Part Number	Description
557402	Blowout disk retaining nut with 1/4 in orifice
560701	Relief adapter body for MSA-10 pump
15R130	Relief adapter body for MSA-100 pump
557433	Yellow blowout disk, 1,450 psi (100 bar)
563962	Yellow blowout disk, 6 pack

See page 74 for full list of blowout disk options.

PNEUMATIC DYNA-STAR® FIRE-BALL® 300 50:1



SIMPLY LEGENDARY

Dyna-Star pump modules offer positive displacement lubrication for multiple lubrication points. At the heart of this system is the Graco Fire-Ball pump, the most durable pump in the industry. The entire system consists of a pump module, injectors and system controls. The pump module provides the system inherent pressurization and venting cycles to actuate and reset the injectors.

Reciprocating Air Motor

Continuously pumps grease as long as air is supplied to it, until it stalls against system pressure.

Fire-Ball 300 50:1 Grease Pump

Provides the lubricant pressure needed to activate the automatic lubrication system.

Vent Valve

- Opens a return path to the reservoir between lubrication cycles, allowing the injectors to reset.
- Includes 4,000 psi (276 bar) relief valve.

Strong 12-Gauge Steel Reservoir

- Available in 60 lb (27 kg) or 90 lb (41 kg) reservoirs.
- Matches common bolt pattern.



TYPICAL APPLICATIONS

- Energy, Infrastructure and Heavy Equipment
- In-Plant Manufacturing

TYPICAL FLUIDS

- Oil and grease up to NLGI #2

TECHNICAL SPECIFICATIONS

Maximum Output Flow Rate	54 in ³ /min (885 cm ³) at 60 PSI (4.1 bar) air
Maximum Recommended Pump Speed	76 cycles/min at 0.22 gpm (0.82 liter/min)
Ratio	60:1 theoretical, 50:1 common
Air pressure Operating Range	50 to 60 PSI (3.4 to 4.1 bar)
Air Inlet	3/8 in NPT on pump, 1/4 in NPT on module
Maximum Fluid Output Pressure	8,400 psi (580 bar) bare pump, 3,500 psi (241 bar) with vent valve
Fluid Output Thread	1/4 in NPT on pump, 1/2 in NPSM female on module
Instruction Manual	308955 / 308883

PNEUMATIC DYNA-STAR® FIRE-BALL® 300 50:1

ORDERING OPTIONS

PNEUMATIC DYNA-STAR INJECTOR SYSTEM MODULES

Modules ship fully assembled, complete with vent valve and hydraulic fluid controls.
See below for follower plate options (AFSO is not compatible with follower plate).



Part Number	Reservoir Size	Replacement Reservoir	Replacement Pump	Pump Repair Kits	
				Air Motor	Pump Lower
25D096	60 lb (27 kg)	247575	239877	206728	241623
241573	90 lb (41 kg)	241486	239887		

MODULE ACCESSORIES

	Part Number	Description
	215407	Air Solenoid – 150 PSI (10 bar) max, 24 VDC or 120 VAC , 1/4 in NPT with 3/8 in NPT adaptors.
Image Coming Soon	114488	Air Solenoid – 150 PSI (10 bar) max, 24 VDC only, 3/8 in NPT ports.
	109075	3/8 in NPT air regulator with gauge
	110150	FRL combo kit – includes air filter, regulator, pressure gauge, lubricator and connection fittings
	241485	Follower plate
	77X522	Low level switch kit – requires follower plate
	241572	Vent Valve Kit – included with packages 25D096 and 241573
	115122	Replacement Relief Valve – 4,000 psi (276 bar) relief pressure
	115124	Pressure switch – pressure adjustment visible in window
	24N181	Pressure switch – 1/4 in NPT(F) inlet, DIN connector (1 NO/1 NC), 7,250 psi (500 bar)



HYDRAULIC PUMP SELECTION GUIDE

Pump Family	Typical Applications	Fluid Type	Maximum Output Pressure psi (bar)	Maximum Output Volume in ³ (cm ³)	Reservoir Capacity Options		Metering	Reference Page
					US	Metric – Liters		
Modu-Flo® 	<ul style="list-style-type: none"> • Energy, Infrastructure and Heavy Equipment • In-Plant Manufacturing 	Oil/grease up to NLGI #2	3,000 (207)	0.12 (1.97) per stroke	Oil – 5, 6, 12, 20, 24 or 40 pints Grease* – 3, 6 or 12 lbs	Oil – 2.4, 2.8, 5.5, 9, 11 or 19 Grease – 1.5, 3 or 6	SLP	82
Hydraulic Dyna-Star® 10:1 and 5:1 	<ul style="list-style-type: none"> • Energy, Infrastructure and Heavy Equipment • In-Plant Manufacturing 	Oil/grease up to NLGI #2	7,500 (517)	36 (590) per minute	60 or 90 lb reservoir	30 or 45 L reservoir	SPDV or SLP	83-86
					or standard barrel length options			

*See page 43 for note on legacy Trabon grease reservoir volumes and metric conversions.



= Single Line Parallel (Injectors)



= Series Progressive Divider Valve

TRUE MODULARITY

Wide choice of standard modular components helps you meet application requirements more exactly without the added cost of a custom system. A complete Modu-Flo modular pumping package (MPP) includes a pump, a baseplate manifold, a reservoir and a variety of optional accessories. For more details, refer to brochure L12000 on Graco.com.

Polycarbonate (Plastic) And Metal Reservoir Options (not shown)

- For oil or for grease, a total of 16 options are available. (See page 73).

Baseplate Manifold Kit (not shown)

- All plumbing connects to the manifold.
- Options for use with NPT or BSP fittings. (See page 181).
- Flapper valve inside works with modular pump design to allow removal and replacement of pump without draining lubricant from the reservoir.



Adjustable Output

Permits a broad range of applications.

Modular Pump Design

- With options for pneumatic (page 71) or hydraulic power, a total of six models are available.
- Hydraulic pumps all utilize double-acting hydraulic motors (not reciprocating).

TYPICAL APPLICATIONS

- In-plant
- Presses
- Mixers

TYPICAL FLUIDS

- Oil and grease up to NLGI #2

TECHNICAL SPECIFICATIONS

Output per Stroke	0.010 in ³ to 0.120 in ³ (0.164 cm ³ to 1.966 cm ³)
Hydraulic Motor Action	Double
Lube Piston Action	Single
Instruction Manual	332042

ORDERING OPTIONS

MODU-FLO PUMPS

Pump Part Number	Model	Pump Ratio	Pump Output Range per Stroke in ³ (cm ³)	Maximum Cycles per Minute		Input Hydraulic Pressure Range PSI (bar)		Maximum Fluid Outlet Pressure PSI (bar)	Repair Kit Part Number
				Oil	Grease	Minimum	Maximum		
563305	HLJ-5M	5.5:1	0.010 to 0.030 (0.164 to 0.492)	60	10	200 (13.8)	2,000 (138)	3,000 (207)	563905
563307	HLJ-25M		0.030 to 0.120 (0.492 to 1.966)	50					563906

Complete your Modu-Flo pump package with a Baseplate Manifold, Reservoir, and Accessories from the Pneumatic Modu-Flo Pump Section on page 73, or refer to bulletin L12000. When replacing an older pump such as HLJ-5A, HLJ-25A, etc., refer to the "Remote" Pump Manifold options to allow wall-mounting of the new pump, instead of mounting directly to bottom of a reservoir.



HYDRAULIC DYNA-STAR®

FIELD PROVEN, ENERGY EFFICIENT

Hydraulic Dyna-Star pumps provide reliable, quiet, ice-free performance at maximum pressure and low flow rates and are up to three times more energy efficient than comparable compressed-air systems.

High-Efficiency Motor Design

Uses less hydraulic oil.

Self-Lubricating Vertical Design

For long life and reliable operation in high vibration environments.

10:1 Ratio For Lower Hydraulic Pressure

Full pressure performance by safely tapping low pressure hydraulics.

Quiet Hydraulic Motor

No need for add-on mufflers.

Multiple Pump And Accessory Options

For use with refinery drum and custom tank installations.

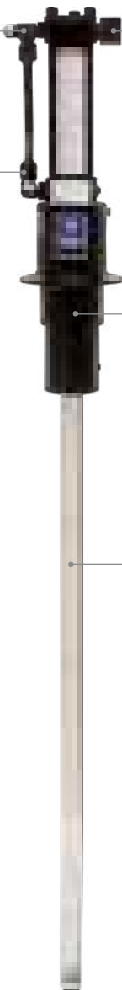

HYDRAULIC PUMPS

TYPICAL APPLICATIONS

- Energy, Infrastructure and Heavy Equipment
- In-Plant Manufacturing

TYPICAL FLUIDS

- Oil and grease up to NLGI #2

TECHNICAL SPECIFICATIONS

Maximum Hydraulic Fluid Input Volume	3 gpm (11 lpm)
Maximum Output Flow Rate	36 in ³ (0.59 l)/min
Maximum Cycles per Minute	60
Hydraulic Supply Inlet	3/4 in -16 JIC-8 (37° flare) male
Hydraulic Return Outlet	3/4 in NPT
Incoming Hydraulic Fluid Maximum Temperature	200°F (93°C)
Maximum Fluid Output Pressure	7,500 psi (517 bar)*
Maximum Hydraulic Input Pressure	600 psi (41 bar)
Fluid Outlet Thread	1/2 in NPT female
Instruction Manual	312350

*When used in an injector system, the vent valve limits maximum to 3,500 psi (241 bar).

HYDRAULIC DYNA-STAR®

ORDERING OPTIONS

HYDRAULIC DYNA-STAR PUMPS

Part Number	Description	Container Size	Overall Pump Length	Pump Lower Length
2008088	Dyna-Star 10:1, 60 lb (27 kg) pump*	60 lb (27 kg)*	33.9 in (861 mm)	19.15 in (501 mm)
247443	Dyna-Star 10:1, 90/120 lb (41/55 kg) pump*	90/120 lb (41/55 kg)*	41.5 in (1,054 mm)	26.75 in (679 mm)
247450	Dyna-Star 10:1, 400 lb (180 kg) pump	400 lb (180 kg)	48.5 in (1,232 mm)	33.75 in (857 mm)

*Used in Graco 60 or 90 lb (27 or 41 kg) reservoirs.

HYDRAULIC PUMP INJECTOR SYSTEM MODULES

Modules ship fully assembled, complete with vent valve and hydraulic fluid controls. See below for follower plate options (AFSO is not compatible with follower plate).

Part Number		Pump Ratio	Auto-Fill Shut Off (AFSO)	Instruction Manual
Reservoir Size				
60 lb (27 kg)	90 lb (41 kg)			
-	243159*	5:1*		309098
247574	247444	10:1		312349
-	24Y407		•	3A3429

*5:1 pump is normally used to replace existing pumps with the same or similar ratio. For new applications use 10:1 pumps.

HYDRAULIC PUMP PACKAGES

Packages are kits with popular components included in one part number. Some assembly required.

Module Part Number	Series Progressive System or Bulk Fluid Dispensing		Injector Pump Kits, without Reservoir – Mount to existing reservoir or refinery drum		
	247706	247707	26C537	26C538	26C539
Container Size	60 lb (27 kg)	90 lb (41 kg)	60 lb (27 kg)	90/120 lb (41/55 kg)	400 lb (180 kg)
Pump Ratio	10:1		10:1		
Bare Pump Part Number	2008088	247443	2008088	247443	247450
Reservoir Assembly	247575	241486	-		
Hydraulic Control Assembly	247538	247538	247538	247538	247538
Follower Plate	-		-		
Drum Cover	-		-		
Low Level Switch Kit	-		-		
Manual Pressure Relief Kit	247902	247902	-		
Pump Mounting Gasket	-		15M442	15M442	15M442
Vent Valve Kit	-		243170	243170	243170
Instruction Manual	312349		-		



ORDERING OPTIONS

RESERVOIR ASSEMBLIES









Part Number		Description
Container Size		
60 lb (27 kg)	90 lb (41 kg)	
247575	241486	Standard Dyna-Star Reservoir complete with cover
25C950	25C951	Bare Dyna-Star Reservoir with side port for Low Level Switch, no cover. Use to add LL sensor to an existing module. Sensor 17L372 sold separately.

FOLLOWER PLATES AND DRUM COVERS FOR 10:1 PUMPS

Part Number			
Container Size			
60/90 lb* Graco reservoir	120 lb refinery drum	400 lb refinery drum	Description
247700	247701	247702	Follower Plate
-	247703	247704	Drum Cover

*Follower plate can not be used with AFSO option.

ACCESSORIES AND REPLACEMENT PARTS

	Part Number	Description
	15M442	Pump mounting gasket
	243170	Vent valve kit
	247538	Hydraulic control module
	243191	Follower plate for 60 or 90 lb reservoir with 5:1 pump
	244023	Level indicator for 60 lb and 90 lb modules, cover-mount, with flying leads*
	77X522	Level indicator for 60 lb and 90 lb modules, cover-mount, with DIN connector*
Image Coming Soon	17L372	Low level switch for AFSO modules that include side port for switch
	115124	Pressure switch - pressure adjustment visible in window
	24N181	Pressure switch, 1/4 in NPT(F) inlet, DIN connector (1 NO/1 NC), 7,250 psi (500 bar)
	247902	Manual pressure relief (dump valve) kit for 247706 and 247707

*Cover-mount low level switches require follower plate (sold separately). Not Compatible with AFSO option.

HIGH-PRESSURE 10:1 HYDRAULIC DYNA-STAR®

10,000 PSI (689 BAR) HYDRAULIC LUBRICATION PUMP FOR 120 LB (55 KG) KEGS

High Pressure Pump and Reciprocator used for dispensing grease in wireline applications for oil well services.



Self-Lubricating Vertical Design

For long life and reliable operation in high-vibration environments.

Dyna-Star® Hydraulic Reciprocator

Time proven, Graco quality.

Outlet Port

13/16-16 UNC thread in pump body, ships with 1/2 NPT adapter included.

Pump Lower

Specially designed for the high pressure required for wireline lubrication.

Pump Shovel

Helps feed grease into the pump.

TECHNICAL SPECIFICATIONS

Maximum Hydraulic Fluid Input Volume	3 gpm (11 lpm)
Maximum Output Flow Rate	1.1 lb/min (0.5 kg/min)
Maximum Cycles per Minute	60
Hydraulic Supply Inlet	3/4 in -16 JIC-8 (37° flare) male
Hydraulic Return Outlet	3/4 in NPT
Incoming Hydraulic Fluid Maximum Temperature	200°F (93°C)
Container Size	120 lb (55 kg)
Overall Pump Length	41.5 in (1054 mm)
Pump Lower Length	26.75 in (679 mm)
Maximum Fluid Output Pressure	10,000 PSI (689 Bar)
Maximum Hydraulic Input Pressure	900 PSI (62 Bar)
Fluid Outlet Thread	13/16 in -16 UNC female
Instruction Manual	3A3005

TYPICAL APPLICATIONS

- Wireline lubrication
- Wellhead gate valve and plug valve greasing

TYPICAL FLUIDS

- Oil and grease up to NLGI #2

ORDERING OPTIONS

HIGH-PRESSURE HYDRAULIC DYNA-STAR® PUMP

Part Number	Description
25A189	Dyna-Star 10:1, 120 lb (55 kg) pump

MECHANICAL PUMP SELECTION GUIDE

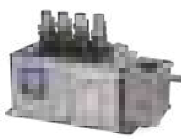

Pump Family	Typical Applications	Fluid Type	Maximum Output Pressure psi (bar)	Maximum Output Volume per Stroke in ³ (cm ³)	Reservoir Capacity Options		Metering	Reference Page
					US	Metric - Liters		
Lube Master® 	<ul style="list-style-type: none"> In-Plant Manufacturing 	Oil/grease up to NLGI #2	5,000 (345)	Direct Drive – 8.6 (143) Clutch Drive – 1.25 (20) per minute	Oil – 12 or 20 pint Grease* – 6 or 12 lb	Oil – 5.5 or 9 Grease – 3 or 6	SPDV	88-90
Manzel® MBL® 	<ul style="list-style-type: none"> Energy, Infrastructure and Heavy Equipment 	Oil – 80 to 5,000 SUS	7,500 (517)	2.7 (44) per element, per minute, adjustable Up to 24 pump elements	4, 6, 8, 12, 16, 24, 32 or 40 pint	1.9, 2.8, 3.8, 5.7, 7.6, 11, 15 or 19	SPDV or PTP	91-94

*See page 89 for note on grease reservoir volumes and the metric weight conversions.



= Series Progressive Divider Valve



= Pump to Point

LUBE MASTER® RATCHET DRIVE PUMP

RUGGED AND RELIABLE

Lubricates only while the machine is running! The Lube Master Clutch Drive is a rugged, reliable pump powered mechanically by the machine using the lubrication. This pump is ideal for applications where lubrication cycles vary and are unpredictable.

Low Level Switch Options

Available for both oil and grease reservoirs.

Direct or Clutch Drive

- Direct Drive provides shaft to receive a pulley or sprocket
- Clutch Drive functions like a ratchet arm to be driven linearly.



Reservoir Options

For oil or grease, 12 or 20 pint/pound, plastic or metal.

Adjustable Pump Displacement

Set the pump output with the turn of a wrench.

TECHNICAL SPECIFICATIONS

Output per Stroke	0.010 to 0.050 in ³ (0.164 to 0.819 cm ³)
Maximum Output Pressure	5,000 psi (340 bar)
Maximum Torque at Rated Maximum Pressure	27 ft lbs (36.6 N-m)
Reservoir Size	Oil – 12 pint or 20 pint / Grease – 12 lb or 20 lb
Reservoir Material	Plastic (polycarbonate) or metal, cylindrical
Instruction Manual	3A2781

TYPICAL APPLICATIONS

- In-plant – presses, Banbury mixers, rubber mills, upsetters, heading machines, crane trolleys, chains, conveyors

TYPICAL FLUIDS

- Oil and Grease up to NLGI #2

DIRECT DRIVE

Pump Output Ranges	RPM at Drive shaft	Pump Strokes per Minute	Output per Minute in ³ (cm ³)	
			Minimum	Maximum
Minimum	1	1	0.01 (1.64)	0.05 (8.20)
Maximum	175	175	1.75 (28.7)	8.75 (143.3)

CLUTCH DRIVE

Pump Output Ranges	Degree of Throw	Impulses per Minute	Pump Strokes per Hour	Output per Hour in ³ (cm ³)	
				Minimum	Maximum
Minimum	12	5	10	0.1 (1.64)	0.5 (8.19)
Maximum	60	150	1,500	15 (246)	75 (1,229)



ORDERING OPTIONS

POPULAR LUBE MASTER ASSEMBLY MODELS

Pressure Gauge 2007096 is included with every LMxxxx assembly.

With Low Level Switch	Reservoir		Drive Type
	Material	Capacity	

GREASE PACKAGES

LM5214	Plastic	12 pound	Clutch drive with ratchet arm
LM6214		20 pound	
LM7214	Metal	12 pound	
LM8114		20 pound	Direct drive, shaft only



OIL PACKAGES

LM1215	Plastic	12 pint	Clutch drive with ratchet arm
LM4215	Metal	20 pint	

See page 42-45 for a complete Lube Master ordering menu.



ACCESSORIES

PRESSURE INDICATORS

	Grease – Aluminum-colored disk, 2,350 PSI (162 bar)	Oil – Yellow-colored disk, 1,450 PSI (100 bar)	Description
	563184	563179	Standard blowout fitting
	563385	563384	High-pressure blowout switch kit*
	563965	563962	Package of 6 blowout disks

*Each kit requires approximately 3 ft of 1/4 in OD copper tubing, not included.



LOW LEVEL SWITCHES – GREASE

	Part Number	Description
	563322	Standard SPDT, 15 amp switch kit, mounts to top of all grease reservoirs
	564318	High/low level switch kit, for metal grease reservoirs only
	564377	Explosion-proof low-level switch for grease reservoirs. (Class I, Group C and D; Class II, Group E, F and G)

LUBE MASTER® RATCHET DRIVE PUMP

ORDERING OPTIONS

LOW LEVEL SWITCHES – OIL

	12 Pint	20 Pint	Description
	563015	563016	SPST, 10 watt, most popular option
	563316	563317	SPDT, 15 amp, for use with heavy or stringy oils

SPARE PARTS

	Part Number	Description
	563383	Replacement clutch drive with ratchet arm

See pages 42-45 for accessories, repair kits and other spare parts.



MANZEL® MBL BOX LUBRICATORS

FORCE FEED BOX LUBRICATORS

The Manzel Modular Box Lubricator (MBL) provides true modularity that permits customizing a pump-to-point lubrication systems from off-shelf components. MBL pumping packages can also be used with MHH divider valves in a series progressive system. Each moving part is lubricated at all times by the fluid in the reservoir. This and the wide range of options, high discharge pressure and rugged construction make the MBL ideally suited for a wide variety of industries and applications.

GBL 7500 Pumps

Modern design that has become the industry standard. See page 59 for pump part numbers.

Suction Pumps Installed

- Use ordering menu on page 59 to specify pumps to be installed.
- Gravity and pressure feed pumps are sold separately for field installation.

Modular Drive

External drive assemblies available as replacement parts.



Heater Port

Integrated 1 in NPT port makes optional electric heater installation simple.

Heavy Steel Reservoirs

Eight reservoir capacities are available to hold up to 40 pints and 24 pumps.

TECHNICAL SPECIFICATIONS

Maximum Pressure	7,500 psi (517 bar)
Operating Temperature	-20°F to 140°F (-29°C to 60°C)
Reservoir Size	See the following pages
Maximum Run Time	Continuous
Output per Element/Min	0.7, 1.2 or 2.7 in ³ (11.45, 19.65 or 44.25 cm ³)
Certifications/Standards	ATEX (depending on configuration)
Instruction Manual	3A2100

TYPICAL APPLICATIONS

- Compressors – petrochemical, refineries, gas transmission and more
- Edgers, planers and band saws
- Rubber mixers
- Cannery lid presses

TYPICAL FLUIDS

- Mineral oil base or synthetics
- 80 to 5,000 SUS

MANZEL® MBL PUMP/RESERVOIR COMBINATIONS WITHOUT PUMPS

ORDERING OPTIONS

DIRECT DRIVES

1:1 ratio means the camshaft turns at the same speed as the drive shaft. Maximum input speed 50 RPM.

	Reservoir Size							
	4 pint (1.9 L), 2 feed	6 pint (2.8 L), 3 feed	8 pint (3.8 L), 5 feed	12 pint (5.7 L), 8 feed	16 pint (7.6 L), 12 feed	24 pint (11 L), 16 feed	32 pint (15 L), 20 feed	40 pint (19 L), 24 feed
Right Hand End	MBA0AA	MBB0AA	MBC0AA	MBD0AA	MBE0AA	MBF0AA	MBG0AA	MBH0AA
Left Hand End	MBA0AE	MBB0AE	MBC0AE	MBD0AE	MBE0AE	MBF0AE	MBG0AE	MBH0AE
Replacement Camshaft	564173	564174	564178	564182	560387	560388	560389	560390

MBL DIRECT DRIVE WITH THRU SHAFT

Cam shaft protrudes from both right and left hand end of reservoir. Each end includes a #5 woodruff keyway on 5/8 in (15.9 mm) diameter shaft. Typically used when a pump-to-point system requires multiple oils/lubricants. As with other MBL assemblies, each pump station includes a single lobe cam.

	Reservoir Size	
	16 pint (7.6 L), 12 feed	24 pint (11 L), 16 feed
Reservoir and Shaft Combo	564290	25N624
Replacement Camshaft	561370	560392

RATCHET ARM DRIVES

Driven by mechanical power via the ratchet arm*.

	Reservoir Size							
	4 pint (1.9 L), 2 feed	6 pint (2.8 L), 3 feed	8 pint (3.8 L), 5 feed	12 pint (5.7 L), 8 feed	16 pint (7.6 L), 12 feed	24 pint (11 L), 16 feed	32 pint (15 L), 20 feed	40 pint (19 L), 24 feed
Right Hand End	MBA0AB	MBB0AB	MBC0AB	MBD0AB	MBE0AB	MBF0AB	MBG0AB	MBH0AB
Left Hand End	MBA0AF	MBB0AF	MBC0AF	MBD0AF	MBE0AF	MBF0AF	MBG0AF	MBH0AF
Replacement Camshaft	564166	564167	564170	560381	564179	560384	564186	564196

*Ratchet arm 563005 sold separately.

ROTARY RATCHET DRIVES

Maximum input speed 800 RPM.

	Drive Ratio	Reservoir Size		
		4 pint (1.9 L), 2 feed	6 pint (2.8 L), 3 feed	8 pint (3.8 L), 5 feed
Right Hand End	37.5:1	MBA0AC	MBB0AC	MBC0AC
Left Hand End		MBA0AG	MBB0AG	MBC0AG
Right Hand End	75:1	MBA0AD	MBB0AD	MBC0AD
Left Hand End		MBA0AH	MBB0AH	MBC0AH
Replacement Camshaft		564168	564171	564172



ORDERING OPTIONS

END ROTARY DRIVES

Offered for Right Hand End only.

Drive Ratio	Reservoir Size				
	4 pint (1.9 L), 2 feed	6 pint (2.8 L), 3 feed	8 pint (3.8 L), 5 feed	12 pint (5.7 L), 8 feed	16 pint (7.6 L), 12 feed
25:1	MBA0AJ	MBB0AJ	MBC0AJ	MBD0AJ	MBE0AJ
50:1	MBA0AK	MBB0AK	MBC0AK	MBD0AK	MBE0AK
100:1	MBA0AL	MBB0AL	MBC0AL	MBD0AL	MBE0AL
200:1	MBA0AM	MBB0AM	MBC0AM	MBD0AM	MBE0AM
400:1	MBA0AN	MBB0AN	MBC0AN	MBD0AN	MBE0AN
Replacement Camshaft	564166	564167	564170	560381	564179

ACCESSORIES

Part Number	Description
563005	Ratchet arm required for drives "B" and "F"
559037	Gravity Supply Auto-Fill Valve, for use with overhead day tank (refer to Modu-Flo oil tanks for options)
564015	Basic Low Level Switch – Single-pole, single-throw. 10 watts @ 120 VAC.
563013	Explosion Proof Low Level Switch – Single-pole, double-throw. Class 1 Group C and D requirements. Class 2 Group E, F and G requirements.
25T989	Cam replacement kit – includes cam, key, and set screw for one pump station. For replacement cam shafts, see tables above.

See page 226-230 for a complete MBL ordering menu and more accessories.

MANZEL® MB SPECIALTY BOX LUBRICATORS

LONG LIFE AND DURABILITY

Leak-proof welded steel reservoir and solid steel, hardened cams. Double-supported cam shafts and gear drives to eliminate cantilevered assemblies and high load capacity needle bearings and ball bearings.

MB118 BOX LUBRICATORS

- "Model 55" 118:1 reduction drive
- 4 or 6 pump stations max, use with any GBL 7500 pumps
- Maximum input speed 1,800 rpm
- Instruction Manual number 3A3006

MB60 BOX LUBRICATORS

- Rear 60:1 reduction drive
- Perfect for bolt-on gas compressor box lubrication solutions
- 2 or 4 pump stations max, use with gravity-fed or pressure-fed GBL 7500 pumps
- Maximum input speed 1,800 rpm
- Instruction Manual numbers 3A2953, 334210



ORDERING OPTIONS

MB118 BOX LUBRICATORS

4 PINT (1.9 L), 4 PUMP CAPACITY

For triplex mud pumps

Drive End		GBL 7500 Pumps*		Maximum Output Pressure
Left Hand	Right Hand	Quantity	Size	
25R513	24W633	0	N/A	N/A
25R557	24W636	3	1/4 in	6,000 psi (414 bar)

6 PINT (2.8 L), 6 PUMP CAPACITY

For quintuplex mud pumps

Right Hand Drive End	GBL 7500 Pumps*		Maximum Output Pressure
	Quantity	Size	
24W634	0	N/A	N/A
24W635	5	1/4 in	6,000 psi (414 bar)

MB60 BOX LUBRICATORS

2 PINT (0.95 L), 2 PUMP CAPACITY

Left Rear Drive

Mount Orientation		GBL 7500 Pumps*	
Floor	Wall	Quantity	Size
24V068	25A071	0	N/A

6 PINT (2.8 L), 4 PUMP CAPACITY



Center Rear Drive

Drive Shaft		GBL 7500 Pumps*	
Keyway	Tang	Quantity	Size
24U750	24N724	0	N/A

*See page 232 for GBL 7500 part numbers and more tech specs, including metric conversions.



MANUAL PUMP SELECTION GUIDE

Pump Family	Typical Applications	Fluid Type	Maximum Output Pressure psi (bar)	Maximum Output Volume per Stroke in ³ (cm ³)	Reservoir Capacity Options		Metering	Reference Page
					US	Metric - Liters		
PH Pump 	<ul style="list-style-type: none"> In-Plant Manufacturing 	Oil/grease up to NLGI #2	3,000 (207)	0.15 (2.5)	Oil – 5, 6, 12, 20, 24 or 40 pint Grease* – 3, 6, or 12 lbs	Oil – 2.4, 2.8, 5.5, 9, 11 or 19 Grease – 1.5, 3 or 6	SPDV	96-97
LubriSystem 	<ul style="list-style-type: none"> In-Plant Manufacturing 	Oil/grease up to NLGI #1	3,000 (207)	0.125 (2)	Oil – 5, 6, 12, 20, 24 or 40 pint Grease* – 3, 6, or 12 lbs	Oil – 2.4, 2.8, 5.5, 9, 11 or 19 Grease – 1.5, 3 or 6	SLP	98

*See page 73 for note on legacy Trabon grease reservoir volumes and metric conversions.



= Single Line Parallel (Injectors)



= Series Progressive Divider Valve

PH PUMP

VERSATILE AND TOUGH

Built with aluminum and steel components to meet the high standards of performance and quality you expect from Graco products. Available with a choice of standard clear plastic or metal Modu-Flo reservoirs for either oil or grease. Modular pump/reservoir design plus built-in features enable the PH Manual Pump to be customized for a wide range of applications.



Pump 563393 shown with 5 lb grease reservoir 562888.

Single-Acting Positive Displacement Pump Design

Minimizes the number of moving and wearing parts for extended pump life and reduced maintenance.

Built-In Volume Indicator

Provides easy verification that lubricant is being delivered to the system and that divider valves are completing lube cycles.

Pressure Relief Valve

Protects system components from over-pressure.

Built-In Outlet Check Valve

Prevents back pressure from damaging pump and minimizes chance for contaminants to get into the pump or the lube supply.

TYPICAL APPLICATIONS

- In-plant
- Mobile Equipment with an installed EZ-Greaser centralized lubrication system

TYPICAL FLUIDS

- Oil and Grease up to NLGI #2

TECHNICAL SPECIFICATIONS

Pump Output	0.15 in ³ (2.46 cm ³) per full stroke
Maximum Operating Pressure	3,000 psi (207 bar)
High Pressure Protection Relief Valve	Set @ 2,500 psi (172 bar)
Force to Operate Handle	29 lb (13.14 kg) per 1,000 psi (69 bar) @ rated pressure
Instruction Manual	L12415







ORDERING OPTIONS

PH PUMP

	Part Number	Description
	563393	PH Pump (without reservoir). Pressure gauge 557864 included.

REPLACEMENT PARTS

	Part Number	Description
	557864	3,000 PSI / 210 bar dual scale pressure gauge
	563160	Pressure relief valve, 2,500 psi (172 bar)
	558906	Mating coupler for grease fill stud
	563924	PH Pump Repair Kit

RESERVOIR OPTIONS

To create your own custom pump package, combine pump 563393 with any of the Modu-Flo reservoirs on page 73.

LUBRISYSTEM

RUGGED VERSATILITY

The LubriSystem hand pump package offers versatility for use in any application, large or small. Great for operation with Injectors or Piston Distributors, with oil or grease. Sturdy construction of aluminum and steel to provide years of service. Compact design can be used in areas where space is limited. Rugged bracket allows the pump package to be mounted in place in any application.



Pump 563580 shown with 12 lb grease reservoir 562884 and pressure gauge 557864

Modular Design

Combine the bare pump with any Modu-Flo reservoir from page 73 to build a custom package.

Polycarbonate Reservoir

High-strength, shatter-resistant material.

Pressure Gauge

Provides visual assurance to the operator that pressure is building to "fire" the injectors.

Built-in Vent Valve

Pull handle from half-stroke to full-stroke repeatedly to build pressure, then return the handle to vertical position to vent the pressure.

TYPICAL APPLICATIONS

- General machinery lubrication where power is limited or not available

TYPICAL FLUIDS

- Oil and Grease up to NLGI #2

TECHNICAL SPECIFICATIONS

Pump Output	0.125 in ³ (2 cm ³) per full stroke
Output Pressure	3,000 psi (207 bar)
Force to Operate Handle	20 lb (9 kg) per 1,000 psi (69 bar)
Instruction Manual	L12100

ORDERING OPTIONS

LUBRISYSTEM PUMP

Part Number	Description
563580	Pump (without reservoir)

ACCESSORIES

Part Number	Description
557864	3,000 PSI / 210 bar dual scale pressure gauge

RESERVOIR OPTIONS

To create your own custom pump package, combine pump 563580 with any of the Modu-Flo reservoirs on page 73.



CONTROLLERS

	Page
Controller Selection Guide	100-101
GLC [®] X Controller and Auto Lube [™] App	102-103
GLC [®] 4400 Controller	104
GLC [®] 2200 Controller	105-106
Grease Jockey [®] Timer	107-108
Solid State Timer	109
Controller Accessories	110-111

CONTROLLER SELECTION GUIDE

Controller	Markets	Power Type	Inputs/Outputs	Modes	Reference Page
GLC X™ Controller and Auto Lube™ App 	<ul style="list-style-type: none"> • Energy, Infrastructure and Heavy Equipment • In-Plant Manufacturing • Vehicle Service 	9–30 VDC	4/2	Pressure / Cycle / Timer	102-103
GLC™ 4400 Series Controller 	<ul style="list-style-type: none"> • Energy, Infrastructure and Heavy Equipment • In-Plant Manufacturing • Vehicle Service 	9–30 VDC or 100–240 VAC	4/4	Pressure / Cycle / Timer	104
GLC™ 2200 Series Controller 	<ul style="list-style-type: none"> • Energy, Infrastructure and Heavy Equipment • In-Plant Manufacturing • Vehicle Service 	9–30 VDC	2/2	Pressure / Cycle / Timer	105-106
Grease Jockey® Timer 	<ul style="list-style-type: none"> • Energy, Infrastructure and Heavy Equipment • Vehicle Service 	9–30 VDC	0/1	Timer	107-108
Solid State Timer 	<ul style="list-style-type: none"> • Energy, Infrastructure and Heavy Equipment • In-Plant Manufacturing 	115/230 VAC	0/1	Timer	109



Feature	Standalone Controllers						Integrated Controllers		
	GLC-X	GLC 4400 AC (24B596)	GLC 4400 DC (24B591)	GLC 2200 (24N468)	Grease Jockey Timer (24W482)	Solid State Timer (562872)	G3 Max	G3 Pro	G-Mini Controller
Voltage	9-30 VDC	100 240 VAC	9-30 VDC	9-30 VDC	9-30 VDC	115/230 VAC	AC: 88-264 VAC 24V: 18-32 VDC 12V: 9-16 VDC		24V: 18-32 VDC 12V: 9-16 VDC
AC Frequency	-	50/60 Hz	-	-		50/60 Hz	AC: 47-63 (50/60) Hz - DC: N/A		-
Max amps (pump output)	10 A	10 A	5 A	7 A		3 A	Internal connection only		
Min On Time	10 secs	1 sec		1 sec		~ 12 secs	1 sec*	1 sec*	1 min
Max On Time	100 hrs (99:59:59) (Timeout) Must be < Interval	100 hrs (99:59:59)		60 mins (59:59)		13 mins	30 mins	30 mins	30 mins
Minimum Cycle Count	1	1 (optional)		1 (optional)	-	-	1 (optional)	-	1
Maximum Cycle Count	100	9,999		99	-	-	99	-	99
Pressure Switch Function	Configurable for both injectors and divider valves	Configurable for both injectors and divider valves		For injectors only	-	-	For injectors only	-	-
Min Off Time	1 min (Interval) Must be > Timeout	1 sec		1 min		30 secs	1 min	1 min	15 min
Max Off Time	100 hrs (99:59) (Interval)	9,999 hrs		100 hrs (99:59)		32 hrs	9,999 hrs (Interval)	9,999 hrs	99 hrs
Stroke/Machine Count	Yes	Yes		-	-	-	Yes	-	-
Minimum Stroke/Machine Count	1	1 (optional)		-	-	-	1 (optional)	-	-
Maximum Stroke/Machine Count	10,000	9,999		-	-	-	9,999	-	-
Pulse mode for pump	Auto Lube App**	Yes		Yes	-	-	-	-	-
PreLube	Yes	Yes		-	-	-	Yes	Yes	Yes
PreLube Delay	Yes	Yes		-	-	-	Yes	Yes	Yes
Low Level Input	Yes	Yes		Yes	-	-	Internal connection only		
Low Level Output	Auto Lube App**	Yes		Yes	-	-	Yes	Yes	Yes
Alarm Output	Auto Lube App**	Yes		Yes	-	-	Yes	LL only	Yes
OK Signal	Auto Lube App**	Yes		-	-	-	Yes	-	-
Manual Run (onboard)	Yes	Yes		Yes	Yes	Yes	Yes	Yes	Yes
Remote Manual Run	Auto Lube App**	Yes		-	-	-	Yes	Yes	Yes
Enclosure Rating (None are explosion proof)	IP69K	IP69K		IP54	IP54	N/A	IP69K	IP69K	IP69K
Page Number	102	104		105-106	107-108	109	19-20	18	13-14

*Note: The 22 rpm motor needs 3 seconds to stroke the G3 or EGJ piston pump once. **These features are available via a Bluetooth connection to the Graco Auto Lube app on your smartphone or tablet.

GLC™ X CONTROLLER

DRIVE MORE PRODUCTIVITY

The powerful, easy-to-use Graco GLC X automatic lubrication controller captures more information so operators, technicians and managers can make faster, smarter decisions. Paired with the intuitive Auto Lube app, users can monitor system performance and make adjustments with incredible speed, precision and freedom from their personal mobile device.

Indoor/Outdoor Mountable (IP69K)

Designed to withstand all the elements, including high-pressure washes and inclement weather encountered at the harshest and dirtiest sites.

Universal Compatibility

One controller for all your lubrication systems simplifies training and inventory.

Real-Time System Reporting

Program and display a wide range of customizable functions – including lubrication intervals, pressure limits, lubricant levels and more.

Active Current Protection

9-30 VDC, 10 amp continuous power supply protects grease pumps from overcurrent and entire system from misfires, electrical shorts and surges.

Easy-to-Read Screen

High-contrast screen features text codes, faults and other data clearly in any ambient light without distracting operators.

Smart Device and Mobile App

With the Auto Lube™ app, monitor lubrication levels, configure settings, track history and share important diagnostics.



Quick Technical Information Access

Easily scan this QR code for access to instruction manuals, guides, video tutorials and more.



Scan Me!



CONTROLLERS

TYPICAL APPLICATIONS

- Heavy construction
- Mining
- Other off-road mobile equipment

TECHNICAL SPECIFICATIONS

Inputs/Outputs	4/2
Power Source	9-30 VDC
Modes	Pressure / Cycle / Timer
Dimensions	3.62 in (92 mm) wide x 6.66 in (169 mm) high x 1.98 in (50 mm) deep
Operating Temperature Range	-22°F to 158°F (-30°C to 70°C)
Protection Grade	IP69K
Instruction Manual	3A7031

GLC™ X CONTROLLER AND AUTO LUBE™ APP







ORDERING OPTIONS

CONTROLLERS

Part Number	Description
26A855	GLC X controller with 20 ft (6 m) cable
26A814	GLC X controller

ACCESSORIES

	Part Number	Description
	26A853	GLC X pump and sensor simulator
	26A882	GLC X wiring harness, 20 ft (6 m) with flying leads
	26A883	GLC X to Compact Dyna-Star®, 3 ft (1 m) cable
	26A888	14-pin mating connector kit
	17G007	Yellow iron mounting bracket with slide adjustment



PRODUCTIVITY LEADS TO PROFITABILITY

Help your crews work faster and minimize downtime by simplifying their everyday lubrication tasks. Designed for today's modern personal mobile device user, the **Graco Auto Lube App** is intuitive and easy to learn for users in the field. They can view historical performance charts, access support and share information with a tap or swipe.

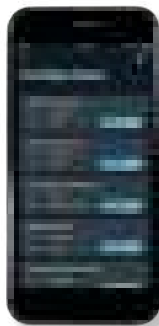

Control Lubrication Profile Configurations

- Customize profiles for equipment and end users
- Quickly and easily assign a Lube Profile Configuration with a GLCX Controller



Manage Devices

- Connect via Bluetooth to get instant status
- Review last-known state on any historical device

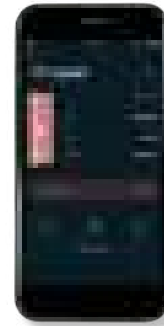

Communicate in Real Time

- See, control, check and clear alarms
- Complete a manual run
- Review and share system history

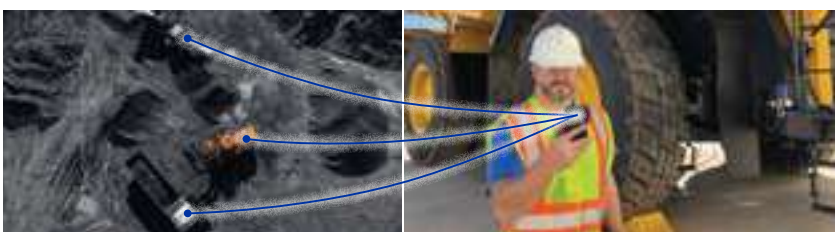

Workers simply need to be within Bluetooth range to perform maintenance tasks faster and easier – directly from their mobile devices.

Download the **Graco Auto Lube** app from Google Play or the App Store (iOS) and perform all controller functions from the convenience of a smartphone or tablet.

GLC™ 4400 CONTROLLER

EASILY MANAGE YOUR AUTO LUBE SYSTEM

Loaded with features and simple to operate. A must-have controller for ensuring critical machine lubrication.

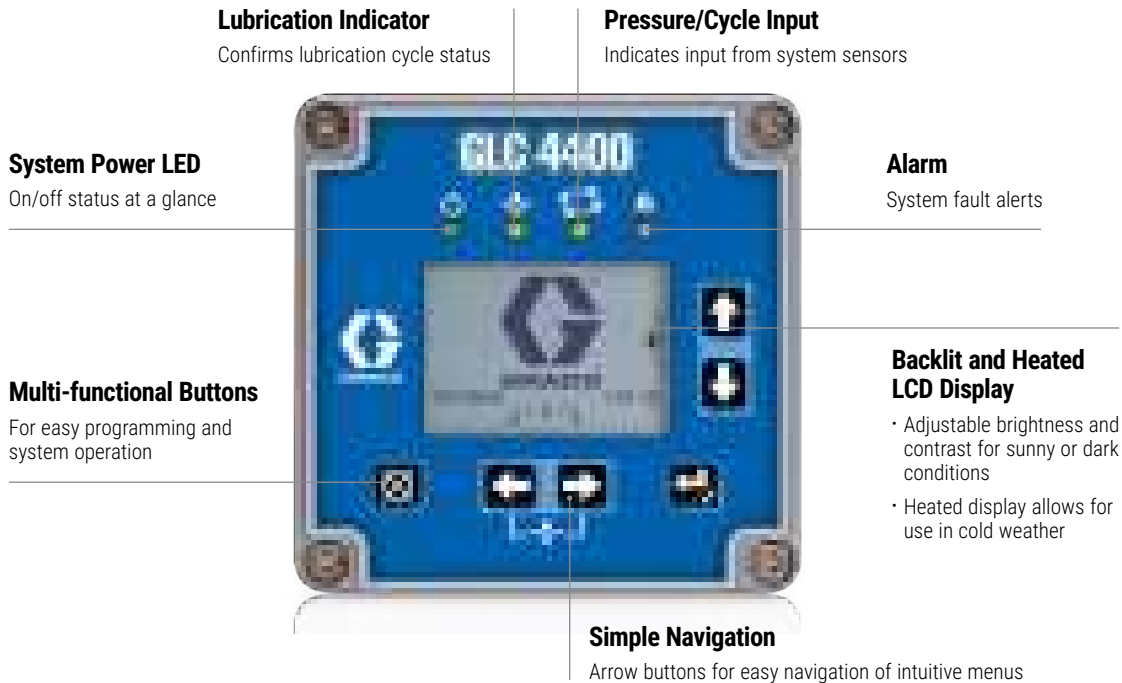

CONTROLLERS

TYPICAL APPLICATIONS

- Heavy construction
- Mining
- Off-road mobile
- In-plant machinery
- Food and beverage equipment
- Wind energy

TECHNICAL SPECIFICATIONS



Dimensions	4.7 in H x 4.8 in W x 3.6 in D (120 mm H x 122 mm W x 91 mm D)
Protection Grade	IP69K
Operating Temperature Range	-40°F to 145°F (-40°C to 63°C)
Net Weight	2 lbs (0.9 kg)
Standards	CE Marked
Instruction Manual	313855

ORDERING OPTIONS

CONTROLLERS

Part Number	Description
24B591	GLC 4400 controller – 9-30 VDC
24B596	GLC 4400 controller – 100-240 VAC

ACCESSORIES

	Part Number	Description
	17J939	Machine/stroke count inductive sensor – 12-24 VDC. NPN normally open, M12 male, 5 mm sensing distance.
	557781	Machine/stroke count SPTD dry contact limit switch – AC/DC. Can be wired N.O. or N.C. Use with cable 124300 and cord grip 260067.

REMEMBER TO ORDER!

	
Proximity Switches See page 165-166	Pressure Switches See page 207



GLC™ 2200 CONTROLLER

COMPACT AND VERSATILE FOR DEMANDING ON-VEHICLE AUTO LUBE

You spend a lot on your equipment. The GLC 2200 controller helps protect components by alerting you to lube events, lube failures and low lubrication levels. You have peace of mind knowing your investment is being protected.

External Mounting Tabs

Easy to mount without having to open up the control box.

Digital Readout

Easy-to-read digital display makes it simple to program and monitor your equipment.

Visual and Audible Alarms

- In-cab visual and audible alarms let the operator know your equipment needs attention.
- Alternatively, set up a remote alarm to alert service or maintenance staff.



LED Indicators

LED lights let you know what your system is doing at a glance.

Intuitive, Protected Control

- Simple icon-based push buttons make programming easy.
- PIN code lockout protects settings.

Plug and Play

Color-coded wiring harness with flying leads and easy-to-follow wiring diagrams makes installations efficient.

TYPICAL APPLICATIONS

- Heavy construction
- Mining
- On-road mobile
- Off-road mobile

TECHNICAL SPECIFICATIONS

Dimensions	5.53 in H x 2.75 in W x 1.38 in D (140 mm H x 70 mm W x 35 mm D)
Protection Grade	IP54
Operating Temperature Range	-40°F to 176°F (-40°C to 80°C)
Standards	CE Marked
Power Source DC	9 to 30 VDC
Instruction Manual	3A2960





GLC™ 2200 CONTROLLER

ORDERING OPTIONS

CONTROLLER

Part Number	Description
24N468	GLC 2200 controller

ACCESSORIES

	Part Number	Description
	24P314	GLC 2200 wiring harness – 5 feet (1.5 m) with flying leads
	24W981	GLC 2200 wiring harness – 10 feet (3 m) with flying leads
	24P686	10-pin mating connector kit
	24P687	10-pin mating connector kit – 5 pack
	16T671	Crimper for 10-pin connector kits
Image Coming Soon	24X606	Mounting bracket kit
	17G007	Yellow iron mounting bracket with slide adjustment

REMEMBER TO ORDER!

 <p>Proximity Switches See page 165-166</p>	 <p>Pressure Switches See page 207</p>
---	--



GREASE JOCKEY® TIMER

DRIVE MORE PRODUCTIVITY

Graco's Grease Jockey Timer is a compact and digital solution for on-road mobile lubrication with simple programming and easy connections. Mount in the cab to complete your pneumatic Grease Jockey auto lube system.

External Mounting Tabs

Easy to mount without having to open up the control box.

Digital Readout

Easy-to-read digital display makes it simple to program and monitor your equipment.

Visual and Audible Alarms

- In-cab visual and audible alarms let the operator know your equipment needs attention.
- Alternatively, set up a remote alarm to alert service or maintenance staff.



LED Indicators

LED lights let you know what your system is doing at a glance.

Intuitive, Protected Control

- Simple icon-based push buttons make programming easy.
- PIN code lockout protects settings.

Plug and Play

Color-coded wiring harness with flying leads and easy-to-follow wiring diagrams makes installations efficient.

CONTROLLERS

TYPICAL APPLICATIONS

- On-road mobile equipment

TECHNICAL SPECIFICATIONS

Power Source	9-30 VDC
Dimensions	5.53 in H x 2.75 in W x 1.38 in D (140 mm H x 70 mm W x 35 mm D)
Operating Temperature Range	-40°F to 176°F (-40°C to 80°C)
Protection Grade	IP54
Instruction Manual	334662



GREASE JOCKEY® TIMER

ORDERING OPTIONS

GREASE JOCKEY TIMERS

Part Number	Description
25A118	Grease Jockey Timer with 10 ft (3 m) cable
24W482	Grease Jockey Timer

ACCESSORIES

	Part Number	Description
	25C771	Grease Jockey Timer wiring harness – 10 ft (3 m) with flying leads
	24P686	10-pin mating connector kit
	24P687	10-pin mating connector kit – 5 pack
	16T671	Crimper for 10-pin connector kits
Image Coming Soon	24X606	Mounting bracket kit



SOLID STATE TIMER

FLEXIBLE AND DEPENDABLE

The Solid-State Timer from Graco is a compact on/off timer solution for AC power with easy to adjust dials. Features an internal terminal strip for simple wiring.



System Power LED

On/off status at a glance

Manual Run Button

Use to check system integrity as well as to simplify system filling and air purging

Dependable Performance

Solid-state technology combined with multiple-level protection

Built-In Memory

Keeps the timer "alive" for 1-1/2 hours during power failures and machine shutdown

TYPICAL APPLICATIONS

- In-plant machinery

TECHNICAL SPECIFICATIONS

Electrical	115/230 VAC; 50/60 Hz; 3 ampere (max.)
Operating Temperature Range	0° to 131°F (-18°C to 55°C)
Storage Temperature Range	-67° to 185°F (-55°C to 85°C)
Enclosure	High-impact plastic
Component Technology	CE Marked
Cycle (Off Time) Range	
Range 1	0.5 to 30 minutes
Range 2	0.5 to 32 hours
On Time Range	0.2 to 13 minutes
Vibration	5g's 50 Hz
Instruction Manual	312055



ORDERING OPTIONS

Part Number	Description
562872	Solid State Timer
558031	Replacement timer board, without enclosure

CONTROLLER ACCESSORIES

ORDERING OPTIONS

DT CONNECTOR KITS

	Part Number	Description
	26A889	12-pin DT female connector kit
	132571	12-pin DT male connector kit – with boot
	26A884	20 ft (6 m) cable, 12-pin DT male x flying leads, 2 x 16 AWG, 10 x 18 AWG. Use with connector kits 26A889 and 132571.

IN-LINE FUSE KITS

For up to 32 VDC

	Part Number	Description
Image Coming Soon	571039	Splash-proof holder with 4 amp blade fuse (557377 plus 124342)
Image Coming Soon	571040	Splash-proof holder with 7.5 amp blade fuse (557377 plus 124343)
Image Coming Soon	25C986	Weatherproof holder with 7.5 amp blade fuse (17P339 plus 124343)
Image Coming Soon	25C985	Weatherproof holder with 10 amp blade fuse (17P339 plus 131206)

FUSE HOLDERS

For up to 32 VDC

	Part Number	Description
Image Coming Soon	131944	Add-a-circuit tap/holder, 32 VDC max, for ATM blade fuses up to 10 amps, 18 AWG wire lead.
Image Coming Soon	17D688	Add-a-circuit tap/holder, 32 VDC max, for ATO blade fuses up to 10 amps, 18 AWG wire lead.
Image Coming Soon	17P339	In-line holder with weatherproof cover, 32 VDC max, for ATO blade fuses up to 30 amps, 12 AWG wire leads.
Image Coming Soon	557377	In-line holder with splash-proof cover, 32 VDC max, for ATO blade fuses up to 20 amps, 16 AWG wire leads.



ORDERING OPTIONS

BLADE FUSES

For up to 32 VDC

Image Coming Soon	Part Number	Size	Amp Rating
	124342	ATO	4
	557264		5
	124343		7.5
	131206		10
	17P340	30	
	131945	ATM	5

NYLON CABLE TIES

	Part Number	Description
	17K063	Single-loop, 14.75 in (375 mm), 100 count package
	563770	Single-loop, 11.5 in (292 mm), 100 count package
	26C980	Double-loop (Figure-8), 15 in (381 mm), 10 count package

P-CLAMPS

	Part Number	Clamp diameter	Mounting hole diameter
	557943	5/16 in (7.9 mm)	9/32 in (7 mm)
	557946	3/8 in (9.5 mm)	
	557944	7/16 in (11.1 mm)	
	557945	5/8 in (15.9 mm)	
	128051	1 in (25.4 mm)	13/32 in (10 mm)

RING TERMINALS

Image Coming Soon	Part Number	Crimp Connector Insulation (Nylon)	Compatible Wire Gauge (AWG)	Compatible Screw/ Stud Size
	104911	Yellow	10-12	#10
	102258	Blue	14-16	3/8 in
	106595	Red	16-22	3/8 in
	109025	Not insulated	18-22	#10
	131230		18	1/4 in
	131229		10	3/8 in

METERING



	Page
How to Design a Metering Device System	114
Metering Device Selection Guide	115
Thrif-T Luber®	116
Piston Distributors	117
GL-32®, GL-43®, GL-33™ and GL-42™ Injectors	118-120
GCI Injectors	121-122
GL-1™ Injectors	123-125
GL-11 Injectors	126
Compact Series Progressive (CSP) Valves	127-128
Trabon® MD Mono-Block Divider Valve	129
Trabon MJ Divider Valve	130-133
Trabon MSP Divider Valve	134-140
Trabon MSP Stainless Steel Divider Valve	141-146
Manzel® MHH Divider Valve	147-151
Trabon MX Divider Valve	152-155
Trabon MXP Divider Valve	156-160
Trabon MGO Divider Valve	161-164
Proximity Switches	165-166
Air Oil Manifold	167

METERING DEVICES

HOW TO DESIGN A METERING DEVICE SYSTEM

AT THE HEART OF EVERY AUTOMATIC LUBRICATION SYSTEM IS A METERING DEVICE.

People often ask why they can't just put a tee in the line to serve two points. The fluid in such a system would take the path of least resistance, leading it to only one of the points. Metering devices are used to prevent fluid from taking the path of least resistance.

As the "heart" of automatic lubrication, the system design process starts with metering. Once the metering system is designed, then an appropriate pump, and usually a controller can be selected to meet the needs of the system that has been designed. Many accessories are also specific to a certain metering device, so accessory selection also depends on the metering device(s) selected for the system.

Ultimately, the choice of which metering device to use for each application is often based on customer preference, but there are differences in functionality and sensor feedback which can influence the decision.

To learn more about system design, including calculating bearing requirements, determining lubrication ratios and component selection, contact your local Account Manager for Graco Lubrication Equipment.

If you are a Graco distributor, you can also ask about upcoming training classes. Attending one of our free classes in person also gives you the opportunity to tour our impressive factory in Anoka, Minnesota!

1

Select the Metering Device

Determined by your fluid type and usage requirements.

Metering Device Types

- SLR – Single Line Resistive Orifice** – Not a true "metering" device; uses a helical path to create resistance on the oil flow.
- SLP – Single Line Parallel** – Requires a pump with a Vent Valve to allow reset between cycles
- SPDV – Series Progressive Divider Valve** – "Trabon" system that uses shifting pistons to measure and route the lubricant pumped through it. Offers the most monitoring options of any metering system.

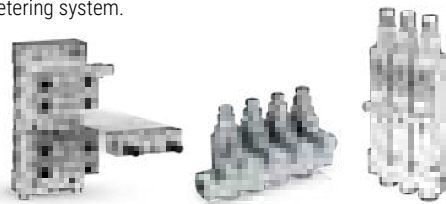
**METERING****2**

Select the Pump

Determined by your metering choice, fluid type and power source.

Pump Power Types

- AC
- DC
- Pneumatic
- Hydraulic
- Manual
- Mechanical

**PUMP****3**

Select the Controller (if needed)

Determined by your usage needs and whether your selected pump offers an integrated controller.

**CONTROLLER****4**

Add Accessories

Complete your metering system with high-quality Graco accessories including proximity and pressure switches, hoses, valves and fittings.

**ACCESSORIES**



METERING DEVICES SELECTION GUIDE

Name	Type	Typical Applications	Fluid Type	Maximum Pressure psi (bar)	Max. Temperature degrees F (C)	Reference Page			
Thrif-T Luber	SLR	Ideal for small to medium-sized lathes or grinders	Oil – 100 SUS to 10,000 SUS	150 (10)	180 (82)	116			
Injecto-Flo II	SLP	Medium-sized cutting machine tools	Oil – 32 to 2,000 cSt	650 (45)	140 (60)	117			
GL-32		In-plant machinery, mobile equipment and anywhere adjustable lubrication output is desired	Grease up to NLGI #2	3,500 (241)	350 (176)	118			
GL-43			Oil –10 weight minimum	1,000 (69)		118			
GL-33			Grease up to NLGI #2	3,500 (241)		119			
GL-42			Oil –10 weight minimum	1,000 (69)		119			
GL-1			Grease up to NLGI #2	3,500 (241)		121-123			
GL-1 Oil			Oil –10 weight minimum			121-123			
GL-1 SST			Grease up to NLGI #2	121-123					
GCI			Grease up to NLGI #2	5,000 (345)		250 (121)	121-122		
GL-1 X			Grease up to NLGI #2	6,000 (414)		123-125			
GL-1 XL			Grease up to NLGI #2			123-125			
GL-11			Grease up to NLGI #2	3,500 (241)		126			
CSP			SPDV	Industrial or mobile applications where space is at a premium		Oil and grease up to NLGI #2	5,076 (350)	212 (100)	127-128
MD						Oil and grease up to NLGI #2	3,000 (207)	212 (100)	129
MJ	Industrial applications where space is at a premium, and diverse output ratios are needed			Oil and grease up to NLGI #1		2,000 (138)	200 (93)	130-133	
MSP	Mobile, industrial, food and beverage, wind and many more	Oil and grease up to NLGI #2		3,500 (241)	350 (176)	134-140			
MSP SST	Food and beverage, off-shore rigs, marine lift cranes, locks and dams, pulp and paper production, chemical processing, oil and gas applications, and other harsh environments such as salty air or areas needing repetitive cleaning	Oil and grease up to NLGI #2		3,500 (241)	140 (60)	141-146			
MHH	Compressors, industrial equipment, and where high-pressure lubrication is required	Synthetic or Mineral Oil		7,500 (517)	350 (176)	147-151			
MX	Pulp and paper, steel mills, heavy- and high-volume industrial applications	Oil and grease up to NLGI #2		3,000 (207)	200 (93)	152-155			
MXP		Oil and grease up to NLGI #2		3,000 (207)	350 (176)	156-160			
MGO		Oil and grease up to NLGI #2		6,000 (414)	350 (176)	161-164			
Air/Oil Manifold		Steel mills, pulp and paper processing, high temperature and dirty environments			250 (17)	200 (93)	167		

METERING TYPES EXPLAINED

SLR	Single Line Resistive Orifice – Not a true "metering" device; uses a helical path to create resistance on the oil flow.
SLP	Single Line Parallel – Requires a pump with a Vent Valve to allow reset between cycles
SPDV	Series Progressive Divider Valve – "Trabon" system that uses shifting pistons to measure and route the lubricant pumped through it. Offers the most monitoring options of any metering system.

SIMPLE SOLUTIONS FOR TIGHT SPACES AND BUDGETS

Thrif-T Luber orifice systems offer an efficient method of applying lubricant, resulting in less machine downtime, increased productivity and a safer work environment. Available in three types and ten flow ranges to meet lube requirements.

Compression Nut With Captured Ferrule Included

For fast, easy connection to 5/32 in (4 mm) OD tubing.



564020



564034

Quality Sintered Bronze Filters

Won't shred or clog like felt.

TYPICAL APPLICATIONS

- Simple time and flow metering system; ideal for small to medium-sized lathes or grinders

TYPICAL FLUIDS

- Oil – 100 SUS to 10,000 SUS

TECHNICAL SPECIFICATIONS

Cracking Pressure	2 psi (0.1 bar)
Maximum Pressure	150 psi (10 bar)
Filter Rating	40 micron
Orifice Type A	Direct to bearing
Orifice Type B	Manifold
Orifice Type C	Direct to bearing or tee

ORDERING OPTIONS

1/8 IN NPT MALE BEARING FITTING

Compression fitting for 5/32 in (4 mm) OD tubing. All three parts are required to make one complete fitting. May also be used inline to mate with standard 1/8 in NPT "female" fittings such as anchor blocks, tees, etc.

Image Coming Soon	558220	TLBF-00	Fitting Body with 1/8 in NPT male thread
	558189	TLCN-00	Compression Nut
	558188	TLCF-00	Compression Ferrule

TUBE CLIPS

Zinc plated carbon steel clips for 5/32 in (4 mm) OD tubing.

Image Coming Soon	558156	TLTC-01	1-Tube
	558159	TLTC-04	4-Tubes

OTHER ACCESSORIES

Image Coming Soon	558190	TLIF-00	5/16 in-24 Inverted Compression Nut, used to attach tubing to manifold. Also requires ferrule 558188
-------------------	--------	---------	--

THRIF-T LUBER RESISTIVE ORIFICES

	Part Number	Reference/Description
		Type A
564019		TLOA-0
564020		TLOA-1
564021		TLOA-2
564022		TLOA-3
564024		TLOA-5
	564025	TLOA-2/0
	Type C	1/8 in NPTF mbe
	564034	TLOC-5



PISTON DISTRIBUTORS

COMPACT METERING SYSTEM WITH A WIDE RANGE OF OUTPUTS

Ideal for medium-sized cutting machine tools.

Piston Distributor Style Single Line Meters

Known worldwide for fast, simple installation.

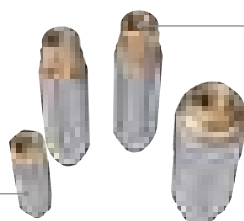

Metering Nipples

Can be changed to fine-tune your dispense volumes.

TYPICAL APPLICATIONS

- Compact metering system with a wide range of outputs; ideal for medium-sized cutting machine tools

TYPICAL FLUIDS

- Oil – 32 to 2,000 cSt

TECHNICAL SPECIFICATIONS

	3400 Series	3500 Series	3900 Series
Oil/Fluid Grease	Oil		
Reset Pressure	150 psi (10 bar)		
Max. Operating Pressure	650 psi (45 bar)		
Max. Operating Pressure	0.0006 to 0.009 in ³ (0.01 to 0.16 cm ³)	0.006 to 0.036 in ³ (0.1 to 0.6 cm ³)	0.012 to 0.09 in ³ (0.2 to 1.5 cm ³)
Metering Nipple Options	5	4	5
Cast Manifold Outlets	2, 3 or 5	2, 3 or 5	2 or 3

ORDERING OPTIONS

3400 SERIES SINGLE POINT PISTON DISTRIBUTORS – OIL

Part Number	Description
558306	0.01 cm ³ output, M8 x 1
558307	0.03 cm ³ output, M8 x 1
558308	0.06 cm ³ output, M8 x 1
558309	0.10 cm ³ output, M8 x 1
558310	0.16 cm ³ output, M8 x 1

3500 SERIES SINGLE POINT PISTON DISTRIBUTORS – OIL

121658	0.10 cm ³ output, M10 x 1
121659	0.20 cm ³ output, M10 x 1
121660	0.40 cm ³ output, M10 x 1
121661	0.60 cm ³ output, M10 x 1

3900 SERIES SINGLE POINT PISTON DISTRIBUTORS – OIL

121665	0.20 cm ³ output, M14 x 1.5
121668	1.00 cm ³ output, M14 x 1.5

3400 CAST MANIFOLDS

122841	2 outlets, oil PD, complete with red plastic cover
122861	3 outlets, oil PD, complete with red plastic cover
122862	5 outlets, oil PD, complete with red plastic cover

3400 METERING NIPPLES

Part Number	Description
558311	0.03 cm ³ (#2)
558312	0.06 cm ³ (#3)
558313	0.10 cm ³ (#4)
558314	0.16 cm ³ (#5)

3500 CAST MANIFOLDS

122866	2 outlets, oil PD, complete with red plastic cover
122868	3 outlets, oil PD, complete with red plastic cover
122869	5 outlets, oil PD, complete with red plastic cover

3500 METERING NIPPLES

558315	0.10 cm ³ (#4)
558316	0.20 cm ³ (#5)
558317	0.40 cm ³ (#6)
558318	0.60 cm ³ (#7)

3900 CAST MANIFOLDS

122888	2 outlets, oil PD, complete with red plastic cover
122889	3 outlets, oil PD, complete with red plastic cover

3900 METERING NIPPLES

558321	0.60 cm ³ (#7)
558322	1.00 cm ³ (#8)
558323	1.50 cm ³ (#9)

SINGLE LINE PARALLEL

GL-32™ AND GL-43™ INJECTORS

ACCURATE, RELIABLE LUBRICATION FOR EVERY LUBE POINT ON YOUR MACHINE

With its one piece design, Graco's GL grease injector systems are easy to design, fast to set up and allow you to add or subtract lube points without having to redesign your lubrication system. Easily handles up to NLGI #2 grease.

Adjustable Lubrication For Each Lube Point

Systems are easy to design, fast to set up and allow you to add or subtract lube points without having to redesign your lubrication system.

Large Selection of Outlet Types and Manifold Quantities

Convenient options for any application.



Versatile High Performance

Versions for oil or grease grades to NLGI #2.

High Temperature Applications – Up To 350°F (176°C)

All injectors come standard with fluoroelastomer seals.

TYPICAL APPLICATIONS

- In-plant machinery, mobile equipment and anywhere adjustable lubrication output is desired

TYPICAL FLUIDS

- Oil (10 weight minimum) and grease up to NLGI #2

TECHNICAL SPECIFICATIONS

	GL-32 Grease Injectors	GL-43 Oil Injectors
Maximum Operating Pressure	3,500 psi (241 bar)	1,000 psi (69 bar)
Minimum Operating Pressure	1,200 psi (83 bar)	750 psi (52 bar)
Typical Operating Pressure	1,500 psi (103 bar)	850 psi (59 bar)
Reset Pressure	200 psi (13.7 bar)	150 psi (10 bar)
Output Volume Per Cycle (adjustable)	0.001 to 0.008 in ³ (0.02 to 0.13 cm ³)	
Maximum Temperature Rating	350°F (176°C)	
Cycle Indication	Visual pin	
Instruction Manual	313798	

ORDERING OPTIONS

Number of Injectors	Inlet Thread	Outlet Fitting	GL-32 Grease		GL-43 Oil
			Carbon Steel	304 Stainless	Carbon Steel
Stand-Alone	1/4 in NPT male	1/8 in OD tube compression	24A919*	24E389*	24E240*
1	1/4 in NPT female		24A921	24E391	24E241
2			24A922	24E392	24E242
3			24A923	24E393	24E243
4			24A924	24E394	24E244
6			25T775	–	–
Replacement			N/A	24A920*	24E390*
1	1/8 in BSPP female	1/8 in OD tube compression	24F509	24F551	24F544
2			24F510	24F552	24F545
3			24F511	24F553	24F546
4			24F512	24F554	24F548
Replacement			N/A	24F508*	24F550*
Repair/Overhaul Kit	N/A		N/A	24B360	24F944

*Must be ordered in quantities of five.

See page 120 for alternate and replacement outlet fittings and more accessories.



GL-33™ AND GL-42™ INJECTORS

Life-Long Seals

Graco-quality manifold and indicator seals deliver increased productivity.

Seven Output Fitting Sizes

Use your preferred size of tubing or hose.

Wide Range of Manifold Options

Manifolds designed to hold up to 15 injectors decreases installation time.

Adjustable Injector Output

Adjust output volume on each injector for a custom fit in any application.

One-Piece Machined Body

Provides durability not seen in other brands.

Visual Indicator Pin

Convenient front-mounted cycle pin indicator confirms that the injector is functioning properly.

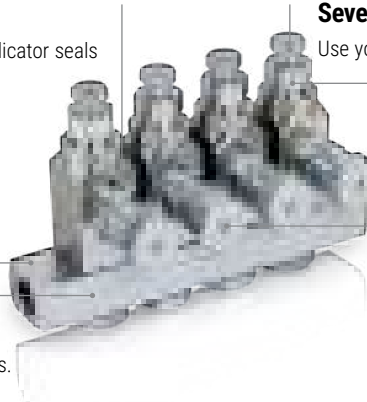

TYPICAL APPLICATIONS

- In-plant machinery, mobile equipment and anywhere adjustable lubrication output is desired

TYPICAL FLUIDS

- Oil (10 weight minimum) and grease up to NLGI #2

TECHNICAL SPECIFICATIONS

	GL-33 Grease Injectors	GL-42 Oil Injectors
Maximum Operating Pressure	3,500 psi (241 bar)	1,000 psi (69 bar)
Minimum Operating Pressure	1,200 psi (83 bar)	750 psi (52 bar)
Typical Operating Pressure	1,500 psi (103 bar)	850 psi (59 bar)
Reset Pressure	200 psi (13.7 bar)	150 psi (10 bar)
Output Volume Per Cycle (adjustable)	0.001 to 0.003 in ³ (0.02 to 0.5 cm ³)	
Maximum Temperature Rating	350°F (176°C)	
Cycle Indication	Visual pin	
Instruction Manual	334495	

ORDERING OPTIONS

Number of Injectors	Inlet Thread	Outlet Fitting	GL-33 Grease		GL-42 Oil		
			Carbon Steel	304 Stainless	Carbon Steel		
Stand-Alone	1/8 in NPT male	1/8 in OD tube compression	24W487*	24W489*	24W493*		
1	1/8 in NPT female		24W401	24W601	24W801		
2			24W402	24W602	24W802		
3			24W403	24W603	24W803		
4			24W404	24W604	24W804		
5			24X302	24X304	24X306		
6			24W405	24W605	24W805		
7			25R873	-	-		
9			24W406	-	24W806		
10			24W407	24W606	24W807		
15			24W408	24W607	24W808		
Replacement			N/A	24W483*	24W485*	24W491*	
Stand-Alone			1/8 in NPT male	6 mm OD tube compression	24W488*	24W490*	24W494*
1			1/8 in BSPP female		24W501	24W701	24W901
2					24W502	24W702	24W902
3		24W503			24W703	24W903	
4	24W504	24W704			24W904		
5	24X303	24X305			24X307		
6	24W505	24W705			24W905		
10	24W506	24W706			24W906		
15	24W507	24W707			24W907		
Replacement	N/A	24W484*			24W486*	24W492*	
Repair/Overhaul Kit	N/A	N/A			24W913	24W914	24W915

*Must be ordered in quantities of five.

See page 120 for alternate and replacement outlet fittings and more accessories.

ACCESSORIES FOR GL-32™, GL-33™, GL-42™ AND GL-43™ INJECTORS

ORDERING OPTIONS

		GL-32, GL-33, GL-42 and GL-43 Outlet Fittings		
		Carbon Steel	Stainless Steel	Nickle-Plated Brass
Porting	JIC-4 male	17B168	17B169	-
	1/8 in OD tube	24B677	24F943	-
	1/8 in OD Push-to-Connect	-	-	17B879
	1/4 in OD Push-to-Connect	-	-	17B880
	1/8 in NPT female	17B780	17B781	-
	4 mm OD tube	24F513	24F555	-
	6 mm OD tube	24F514	24F556	-
	Closure Plug	17B782	17B783	-

ACCESSORIES

Part Number	Description
24W495	Manual grease fitting adapter – compatible with 1/8 in OD tube outlet only
17B785	Measuring chamber vinyl cap





GCI INJECTORS

INJECTOR TECHNOLOGY THAT DEFIES CONVENTION

This revolutionary, new patent pending cartridge injector system from Graco ushers in a new era of automatic lubrication system technology! This system will reduce maintenance frequency, labor and costly downtime and will transform uptime, production capacity and profitability expectations.

Quick-Exchange Injectors

Injector replacements take seconds rather than minutes using either a 24 mm or 15/16 in. socket – without the need to remove any lubrication lines.

Backward Compatible

Uses same mounting pattern as GL-1 and GL-1 X series injectors that also match many competitive mounting patterns.



Locked-In Output

Color-coded output spacers dictate the amount of grease dispensed per lubrication cycle, reducing the likelihood of incorrect field adjustments during repair.



PATENT PENDING

Greater Output Range

0.015 to 0.150 in³, nearly doubling the output of our GL-1 injectors, reducing the need for crossporting multiple injectors in a system

SINGLE LINE PARALLEL

TECHNICAL SPECIFICATIONS

Maximum Pressure	Standard-pressure manifold (aluminum) – 3,500 psi (24.1 MPa, 241 bar) High-pressure manifold (steel) – 5,000 psi (34.5 MPa, 345 bar) GCI 150 cartridges – 5,000 psi (34.5 MPa, 345 bar)
Recommended Operating Pressure	2,500 psi (17 MPa, 172 bar)
Reset Pressure	1,000 psi (6.89 MPa, 68.9 bar)
Output Volume Per Cycle	0.015 to 0.150 in ³ (.25 to 2.46 cm ³)
Recommended Fluids	NLGI #2 grease down to 32° F (0° C)
Wetted Materials	Carbon steel, nitrile rubber, aluminum

MANIFOLD DIMENSIONS

	2-Point	3-Point	4-Point	5-Point	6-Point
Width in (cm)	3.13 (7.94)	4.38 (11.11)	5.63 (14.29)	6.88 (17.46)	8.13 (20.64)
Height in (cm)	3.4 (8.64)				
Distance Between Mounting Holes in (cm)	–	1.25 (3.18)	2.50 (6.34)	3.75 (9.51)	5.00 (12.70)

GCI INJECTORS

ORDERING OPTIONS

Graco cartridge injectors are easy to handle, can be serviced in one minute or less and eliminate the need to disconnect lines when replacing. Numerous injector replacements on a machine can be completed in minutes instead of hours, leaving service technicians with more time to focus on other equipment issues.

STANDARD-PRESSURE MANIFOLDS

Zerks and caps included

Part Number	Description
134362	2-point manifold, 3,500 psi
134363	3-point manifold, 3,500 psi
134364	4-point manifold, 3,500 psi
134365	5-point manifold, 3,500 psi
134366	6-point manifold, 3,500 psi

HIGH-PRESSURE MANIFOLDS

Zerks and caps included

Part Number	Description
134372	2-point manifold, 5,000 psi
134373	3-point manifold, 5,000 psi
134374	4-point manifold, 5,000 psi
134375	5-point manifold, 5,000 psi
134376	6-point manifold, 5,000 psi

GCI 150 INJECTORS

Part Number	Description
134250	Injector - single
134354	Injector - 100-pack

OUTPUT SPACERS

Part Number	Color	Output Target in ³ (cm ³)
134337	Black	0.015 (0.25)
134338	Red	0.030 (0.49)
134339	Silver	0.045 (0.74)
134340	Gold	0.060 (0.98)
134341	Green	0.080 (1.31)
134342	Gray	0.100 (1.64)
134343	Purple	0.125 (2.05)
134344	Blue	0.150 (2.46)

ACCESSORIES

Part Number	Description
134105	Injector crossport kit
133668	Injector port plug
114916	Zerk and cap fitting
134393	Dust cap replacement





GL-1™ INJECTORS

GRACO QUALITY PROVIDES CONSISTENT PERFORMANCE IN RUGGED ENVIRONMENTS

Custom fit your system with Graco's adjustable GL-1 series grease injectors. Designed to meet the needs of each lube point, these systems provide years of reliable operation in the harshest operating environments.

Hex-Head Adjustment Nut

Heavy-duty hex-head nut makes output adjustments simple.

Injector Covers

Clear, polycarbonate covers protect cycle pin indicators from contamination. (Included with GL-1 X and GL-1 XL models)

Unibody Design

Rugged, single-piece body for use in harsh environments.

GL-1 Manifold

6,000 psi, 3/8 in NPT port manifolds fit pre-existing mounting patterns.

Output Spectrum Sleeves

Colored-coded spacers enable simple, targeted output volume.



SINGLE LINE PARALLEL

TECHNICAL SPECIFICATIONS

	GL-1	GL-1 Oil	GL-1 SST	GL-1 X	GL-1 XL
Maximum Operating Pressure	3,500 psi (241 bar)	3,500 psi (241 bar)	3,500 psi (241 bar)	6,000 psi (414 bar)	6,000 psi (414 bar)
Minimum Operating Pressure	1,850 psi (128 bar)	750 psi (52 bar)	1,850 psi (128 bar)	1,850 psi (128 bar)	1,850 psi (128 bar)
Reset Pressure	600 psi (41 bar)	150 psi (10 bar)	600 psi (41 bar)	1,000 psi (69 bar)	1,000 psi (69 bar)
Output Volume Per Cycle	0.008 to 0.08 in ³ (0.13 to 1.31 cm ³)	0.008 to 0.08 in ³ (0.13 to 1.31 cm ³)	0.008 to 0.08 in ³ (0.13 to 1.31 cm ³)	0.015 to 0.08 in ³ (0.25 to 1.31 cm ³)	0.035 to 0.305 in ³ (0.57 to 5.0 cm ³)
Materials	Zinc-plated carbon steel	Zinc-plated carbon steel	316 stainless steel	Zinc-plated carbon steel	Zinc-plated carbon steel

GL-1™ INJECTORS

SINGLE LINE PARALLEL

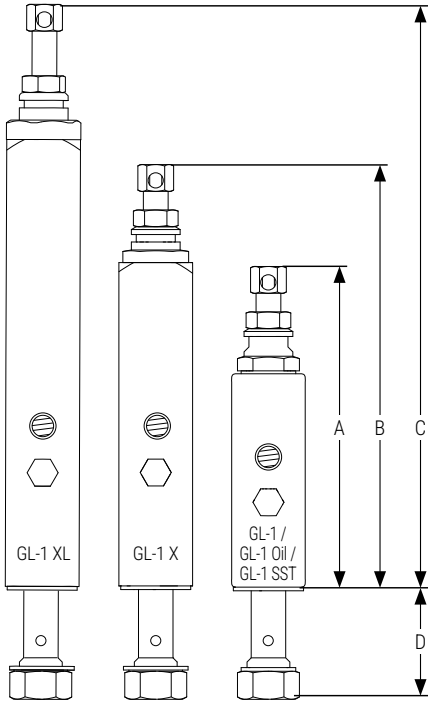

GL-1 Injector Dimensions

A	5.3 in (13.46 cm)
B	6.9 in (17.53 cm)
C	9.5 in (24.13 cm)
D	1.7 in (4.32 cm)

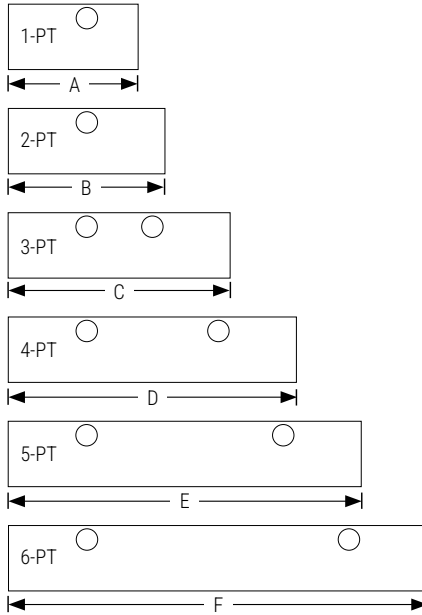

GL-1 Manifold Dimensions

A	2.5 in (6.35 cm)
B	3.0 in (7.62 cm)
C	4.2 in (10.67 cm)
D	5.5 in (13.97 cm)
E	6.7 in (17.02 cm)
F	8.0 in (20.32 cm)



114905



24X807

ORDERING OPTIONS

GL-1 INJECTORS AND MANIFOLD ASSEMBLIES

	GL-1	GL-1 Oil	GL-1 SST	GL-1 X	GL-1 XL
GL-1 one point assembly	114901	25T641	-	24X801	24X811
GL-1 two point assembly	114902	25T642	-	24X802	24X812
GL-1 three point assembly	114903	25T643	-	24X803	24X813
GL-1 four point assembly	114904	25T644	-	24X804	24X814
GL-1 five point assembly	114905	25T645	-	24X805	24X815
GL-1 six point assembly	117206	25T646	-	24X806	24X816
GL-1 single replacement injector (no manifold)	114909	25T649	25N109	24X807	24X817

GL-1 BARE INJECTOR MANIFOLDS (NO INJECTORS INCLUDED)

One bank GL-1 manifold	114911	114911	25N101	114911	114911
Two bank GL-1 manifold	114912	114912	25N102	114912	114912
Three bank GL-1 manifold	114913	114913	25N103	114913	114913
Four bank GL-1 manifold	114914	114914	25N104	114914	114914
Five bank GL-1 manifold	114915	114915	25N105	114915	114915
Six bank GL-1 manifold	118206	118206	25N106	118206	118206



24X817



ORDERING OPTIONS

GL-1 INJECTOR ACCESSORIES

	GL-1	GL-1 SST	GL-1 X	GL-1 XL
Injector Cover Kit, polycarbonate	17L754	17L754	17L754*	17L755*
Injector Crossport Kit	133095	128139	133095	133095
Zerk and Cap Kit (5 pack)	17Y511	17Y498	17Y511	17Y511
Adjustment Screw and Lock Nut (5 pack)	17Y510	17Y489	-	-
Seal Repair Kit	241234	241234	25A081	25A080
GL-1 Oil Conversion Kit	25E349	25E349	-	-
Injector Port Manifold Plug	25D336	-	25D336	25D336

*Included with every GL-1 X and GL-1 XL injector.

GL-1 MANIFOLD MOUNTING WELD BAR

Part Number	Description
17S392	One bank GL-1 manifold
17S392	Two bank GL-1 manifold
17S393	Three bank GL-1 manifold
17S394	Four bank GL-1 manifold
17S395	Five bank GL-1 manifold
17S396	Six bank GL-1 manifold

OUTPUT SPECTRUM SLEEVES

GL-1 Output Target in ³ (cm ³)	Output Target Ratio		Color	10-Pack Part Number
	From Minimum	From Maximum		

GL-1 / GL-1 SST INJECTORS

0.01 (0.1)	1.0	0.10	N/A	N/A
0.03 (0.5)	2.0	0.50	Red	17K601
0.05 (0.8)	3.0	0.60	Silver	17K602
0.06 (1.0)	4.0	0.80	Gold	17K603
0.08 (1.3)	5.0	1.00	Green	17K604

GL-1 X INJECTORS

0.01 (0.3)	1.0	0.20	N/A	N/A
0.03 (0.5)	2.0	0.40	Red	17K601
0.04 (0.7)	3.0	0.50	Silver	17K602
0.06 (0.8)	3.3	0.60	Gold	17K603
0.07 (1.2)	5.0	0.75	Green	17K604

GL-1 XL INJECTORS

0.04 (0.6)	1.0	0.10	N/A	N/A
0.05 (0.8)	1.5	0.15	Red	17K601
0.06 (1.0)	2.1	0.25	Silver	17K602
0.09 (1.5)	2.8	0.30	Gold	17K603
0.12 (2.0)	3.4	0.40	Green	17K604
0.13 (2.0)	3.9	0.45	Black	17N453
0.15 (2.5)	4.3	0.50	Purple	17N454
0.18 (3.0)	5.4	0.60	Blue	17N455
0.21 (3.5)	6.4	0.75	Orange	17N456
0.24 (4.0)	7.5	0.90	Brown	17N457
0.30 (5.0)	8.6	1.00	Yellow	17N458



GL-11 INJECTORS

HIGH VOLUME OUTPUT AT HIGH PRESSURES FOR THE MOST DEMANDING APPLICATIONS

Rugged, medium-pressure metering system for pumping grease; ideal for heavier-duty applications such as mobile mining vehicles, milling, cement batch plants or material processing equipment.

SINGLE LINE PARALLEL

Adjustable Output Volumes

To custom fit the system for each lube point.

24A918

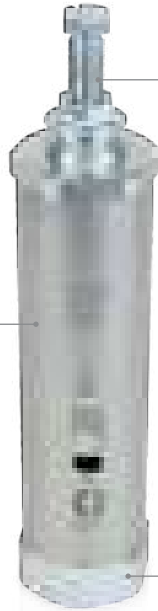

Convenient Top-Mounted Cycle Pin Indicator

Provides quick, at-a-glance confirmation that the injector is functioning properly.

Hex-Head Adjustment

For easy turning from most any orientation.

TYPICAL APPLICATIONS

- Rugged, medium-pressure metering system for pumping grease; ideal for heavier-duty applications such as mobile mining vehicles, milling, cement batch plants or material processing equipment.

TYPICAL FLUIDS

- Grease up to NLGI #2

ORDERING OPTIONS

GL INJECTORS AND ACCESSORIES

Part Number	Description
24A918	GL-11 Injector
24B359	GL-11 Injector Repair Kit
17Y511	GL-11 Zerk and Cap Kit (5 pack)

TECHNICAL SPECIFICATIONS

Reset Pressure	600 psi (41 bar)
Maximum Pressure	3,500 psi (241 bar)
Suggested Operating Pressure	2,500 psi (172 bar)
Minimum Operating Pressure	1,000 psi (69 bar)
Output Range	0.05 to 0.5 in ³ (0.82 to 8.2 cm ³)
Number of Adjustment Turns	14
Cycle Indicator	Visual
Instruction Manual	313704

COMPACT SERIES PROGRESSIVE (CSP) VALVES



GRACO QUALITY IN A COMPACT PACKAGE

Compact Series Progressive (CSP) valve with broad-market versatility. Combine with field-proven Graco pumps for a complete system solution.

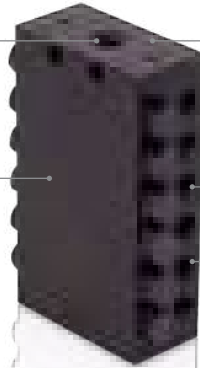

1/8 in NPT or BSPP Inlet

Built-in Durability

Zinc iron plating stands up to harsh environments.

Variety of Configurations

6 to 22 outlets, available with or without indicators.

High Output Pressure

Maximum working pressure of 5,076 psi (350 bar).

Output to Meet Your Needs

0.012 in³ (0.2 cc)/stroke output with the ability to double-up outlets if greater output is required.

TYPICAL APPLICATIONS

- Industrial or mobile applications where space is at a premium.

TYPICAL FLUIDS

- Oil or grease up to NLGI #2

TECHNICAL SPECIFICATIONS

Reset Pressure	600 psi (41 bar)
Maximum Pressure	3,500 psi (241 bar)
Suggested Operating Pressure	2,500 psi (172 bar)
Minimum Operating Pressure	1,000 psi (69 bar)
Output Range	0.05 to 0.5 in ³ (0.82 to 8.2 cm ³)
Number of Adjustment Turns	14
Cycle Indicator	Visual
Instruction Manual	313704

ORDERING OPTIONS

CSP VALVES WITHOUT CYCLE PIN

Number of Outlets	Inlet Port Thread	
	1/8 in NPT	1/8 in BSPP
6	24Z486	24Z477
8	24Z487	24Z478
10	24Z488	24Z479
12	24Z489	24Z480
14	24Z490	24Z481
16	24Z491	24Z482
18	24Z492	24Z483
20	24Z493	24Z484
22	24Z494	24Z485







CSP VALVES WITH CYCLE PIN

Number of Outlets	Inlet Port Thread	
	1/8 in NPT	1/8 in BSPP
6	24Z504	24Z495
8	24Z505	24Z496
10	24Z506	24Z497
12	24Z507	24Z498
14	24Z508	24Z499
16	24Z509	24Z500
18	24Z510	24Z501
20	24Z511	24Z502
22	24Z512	24Z503

COMPACT SERIES PROGRESSIVE (CSP) VALVES



ORDERING OPTIONS

CSP OUTLET FITTINGS

	Part Number	Description
	17Y692	1/4 in OD tube compression with check valve – for use with Nylon tubing
	17Y693	1/8 in NPT female thread with check valve
	17L440	1/4 in OD tube Push-to-Connect with check valve – for use with Nylon tubing
	17L441	1/4 in stud G-Lock Push-to-Connect – connects to G-Lock 1/4 in stud hose end fitting
	17L458	6 mm stud G-Lock Push-to-Connect – connects to hose with G-Lock 6 mm stud hose end fitting
	17L543	6 mm stud Push-to-Connect for nylon tubing
	17L550	6 mm stud compression fitting – connects to hose with 6 mm stud hose end fitting

Refer to page 211 for mating tubing, hose studs and hoses.

CSP VALVE ACCESSORIES

	Part Number	Description
	17L651	Output Doubling Plug – crossports/shunts flow to next outlet further from inlet
	17L879	Solid State Proximity Switch – for electronic cycle indication, 10-36 VDC PNP, M12 electrical connector
Image Coming Soon	17R703	M12 extension cable, 1 ft (30 cm) long. Connect to Solid State Prox Switches when installed on a CSP mounted directly to bottom of a G-Mini or G3 Max pump.
Image Coming Soon	17Y640	Replacement CSP piston enclosure plug
Image Coming Soon	25E935	Acrylic Demo Kit with pneumatic squeeze bulb, CSP-8 without Indicator
Image Coming Soon	25N730	Weld Bar Kit
Image Coming Soon	26A478	Weld Stud Kit
Image Coming Soon	26A479	Weld Stud Template

CSP COMPACT CYCLE SWITCHES

New compact proximity switches mount to the cycle pin assembly on a CSP divider valve and provide electronic cycle indication to G3 and G-Mini pumps with built-in controllers, as well as most external controllers compatible with PNP sensors.

- Use with CSP divider valves with a cycle indicator pin
- LED light on each switch provides visual indication of cycles
- 10-30 VDC PNP, wires the same as other PNP switches
- Wiring diagram is included with each switch
- Rated IP67; UL, CE certified

	Part Number	Description
Image Coming Soon	26C822	Switch assembly with 9.5 in (24 cm) cable to M12 connector. Recommended for a divider valve mounted to the bottom of a G3 Max or SP, or G-Mini Controller pump.
Image Coming Soon	26C823	Switch assembly with 16.5 ft (5 m) cable to flying leads. Recommended for G-Series pumps with a remote mounted valve, and for GLC controllers. M12 connector 124594 (sold separately) is required when wiring to G-Series pumps.

TRABON® MD MONO-BLOCK DIVIDER VALVE



COMPACT VALVE SOLUTION

The Trabon MD Series is the most compact series progressive solution making it a perfect fit for tight-spaced applications.

Available with 2, 3, 4 or 6 Outlets

Fluoroelastomer Seals

For high temperature applications or synthetic lubricants.

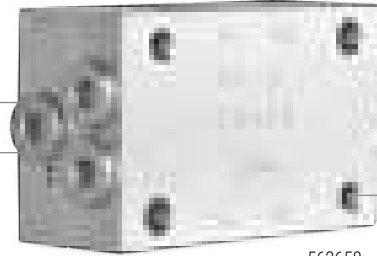

562658

Easy to Install

On new or existing equipment.

TYPICAL APPLICATIONS

- Industrial or mobile applications where space is at a premium.

TYPICAL FLUIDS

- Oil or grease up to NLGI #2

TECHNICAL SPECIFICATIONS

Material	Steel
Maximum Pressure	3,000 psi (207 bar)
Net Weight (approximate)	1 lb 8 oz (0.68 kg)
Max Operating Temperature	350°F (176°C)
Instruction Manual	312497

ORDERING OPTIONS

	Number of Outlets	Output per Outlet, in ³ (cm ³)	Valve Only	Valve with Cycle Pin	Valve with Cycle Switch and Bracket Assembly
MD-2	2	0.040 (0.66)	562656	562653	563270
MD-3	3	Outlet 1 – 0.040 (0.66) Outlet 2 and 3 – 0.020 (0.33)	562657	562654	563271
MD-4	4	0.020 (0.33)	562658	562655	564356
MD-6	6	0.010 (0.16)	562659	N/A	

MD PARTS AND ACCESSORIES

Part Number	Description
17M380	Solid State Proximity Switch – for electronic cycle indication, 10-36 VDC PNP, M12 Electrical Connector
563555	Cycle Indicator Spud assembly
557720	Cycle Indicator Pin (replacement only, not compatible with valves that don't already have the pin)
557781	Replacement SPDT Cycle Switch
122276	Viton O-ring

TRABON® MJ DIVIDER VALVE

COMPACT YET CONFIGURABLE

The Trabon MJ series features a compact and easily customizable design that can be tailor fit to meet a variety of specific lube requirements. Capable of handling grease grades up to NLGI #1.

Space Efficient

From 6 to 16 points from one block assembly.

Output Options

Three different piston sizes, each offered as S (single) or T (twin) outlet valves, allow a variety of ratios without increasing the size of the valve assembly.

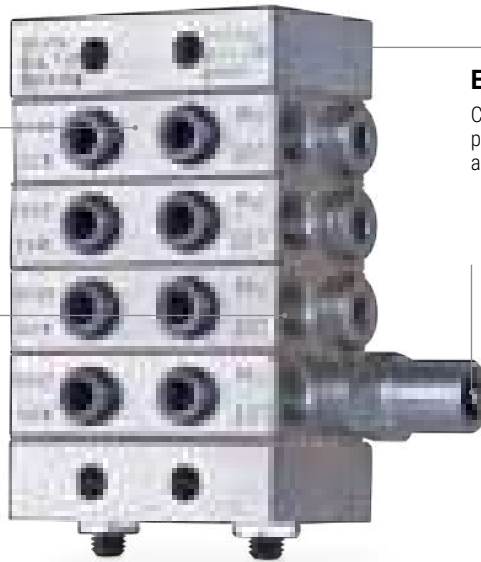

Easily Accessorized

Can be easily accessorized with cycle and performance indicators to provide positive assurance of a successful lube event.

Built-In Outlet Check Valves

Ensure accurate lube delivery, every time.

TYPICAL APPLICATIONS

- Machine tools
- Textile, glass and can machinery

TYPICAL FLUIDS

- Oil or grease up to NLGI #1

TECHNICAL SPECIFICATIONS

Material	Plated Steel
Maximum Pressure	2,000 psi (137.89 bar)
Max Operating Temperature	200°F (93°C)
Max Cycle Rate with Cycle Pin	60 cycles/minute
Instruction Manual	312497



STEPS TO BUILD YOUR MJ DIVIDER VALVE SYSTEM:

A Select Valve Working Sections

B Select Inlet and End Sections

C Select Tie Rods and Tie Rod Nuts

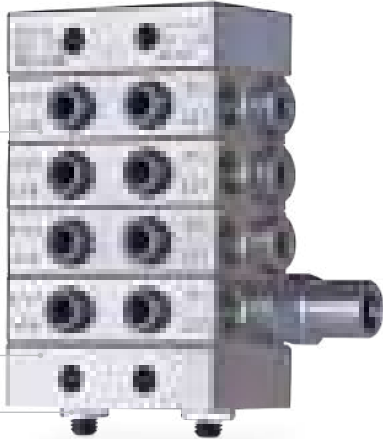

Choose from Optional Accessories

D Cross-port and Singling Bars

E Cycle Indicators and Proximity Switches

F Performance Indicators

G Mounting Bars

A ORDERING OPTIONS

VALVE WORKING SECTIONS

Standard 1/8 in NPSF outlet ports accept NPT fittings. Must be ordered in multiples of five.

Outlet Configuration	Description	Output Per Outlet, in ³ (cm ³)	Part Number	
			Standard Section	With Cycle Pin
Single	MJ-5S	0.010 (0.16)	562500	N/A
	MJ-10S	0.020 (0.33)	562501	562508
	MJ-15S	0.030 (0.49)	562502	562509
Twin	MJ-5T	0.005 (0.08)	562503	N/A
	MJ-10T	0.010 (0.16)	562504	562510
	MJ-15T	0.015 (0.26)	562505	562511

MJ SPARE PARTS AND ACCESSORIES

Part Number	Description
563948	Cycle Indicator Repair Kit
557514	Replacement Gasket
557349	Replacement Outlet Port Plug (one is already included with each "S" section)

B ORDERING OPTIONS

INLET AND END SECTIONS

Must be ordered in multiples of five.

Component	Description	Part Number
Inlet Section	Standard 1/8 in NPSF inlet, accepts NPT fittings.	560643
End Section	Standard end section.	560645

Note: Each valve, inlet and end section is packaged with a gasket, so a complete MJ assembly will have one gasket leftover.

TRABON® MJ DIVIDER VALVE

C ORDERING OPTIONS

TIE RODS AND TIE ROD NUTS

Two tie rods and two tie rod nuts required for each MJ assembly.

Component	Length	Part Number
Tie Rods	3-section	557515
	4-section	557516
	5-section	557517
	6-section	557518
	7-section	557519
	8-section	557520
Tie Rod Nuts	N/A	556371

D ORDERING OPTIONS

CROSSPORT AND SINGLING BARS

For each bar used, order one of part number 557349 (1/8 in NPT pipe plug) to plug the unused outlet.

	Part Number	Component	Description
	562914	Right Crossport Bar	Provides a path to redirect output from one outlet to the next one below it, away from the inlet.
	562915	Singling Bar	Converts a "T" valve to an "S" valve.

E ORDERING OPTIONS

CYCLE INDICATORS AND PROXIMITY SWITCHES

These switches sense the divider valve piston's action for accurate control and monitoring of lube cycles.

Part Number	Component	Description
563272	Single pole, double throw (SPDT) standard cycle switch and bracket assembly	Used in conjunction with the cycle indicator at cycle rates not exceeding 60 cpm, the switch provides an electrical signal to the system controller which counts cycles to monitor and verify completion of the lube cycle. Included bracket clamps to spud around cycle pin.
563273	Moisture-resistant SPDT cycle switch and bracket assembly	
564357	Double pole, double throw (DPDT) cycle switch and bracket assembly	
17M380	Solid State Proximity Switch (see page 161 for mating cables)	This rugged switch has no moving parts, making it ideal for applications such as metal stamping presses and yellow iron equipment. 10-32 VDC PNP switching, M12 electrical connector, 200 cpm, 3,000 PSI (207 bar) maximum pressure. 50,000,000 cycle life, IP65, IP68, IP69 rated.



F ORDERING OPTIONS

PERFORMANCE INDICATORS

These vital safeguards react to excess lube pressure when points or lines become blocked. Installed in indicator ports on the working piston sections, they quickly identify the affected lines. 1/8 in NPT male thread installs in the indicator ports on the front of each valve.

RESET INDICATORS

Features and Benefits

- Provides quick troubleshooting tool with visual indication
- No tools for reset or parts to replace after indication
- Easy information on blocked lines, high system pressure or blocked bearings

	Part Number	Indication Pressure
Image Coming Soon	563231	250 psi (17 bar)
	563232	500 psi (35 bar)
	563233	750 psi (52 bar)
	563234	1,000 psi (69 bar)
	563235	1,500 psi (103 bar)
	563236	2,000 psi (138 bar)

AUTOMATIC RELIEF INDICATORS

These performance indicators pinpoint lube line blockages but allow the lube system to continue to supply lubrication to points that are not blocked.

Features and Benefits

- Provides quick troubleshooting tool with visual indication
- No tools for reset or parts to replace after indication
- Easy information on blocked lines, high system pressure or blocked bearings

	Part Number	Indication Pressure
Image Coming Soon	563163	750 psi (52 bar)
	563164	1,000 psi (69 bar)
	563166	1,500 psi (103 bar)
	563167	2,000 psi (138 bar)

G ORDERING OPTIONS

MOUNTING BAR

Part Number	Component	Description
561101	MJ Divider Valve Weld Bar	1/2 in (12.7 mm) thick steel bars are designed for welding to uneven metal surfaces. Tapped holes are provided for mounting the divider valves. This part is one individual bar, so order quantity 2 when needed.

TRABON[®] MSP DIVIDER VALVE

THE INDUSTRY STANDARD FOR QUALITY AND RELIABILITY

The Trabon MSP Series sets the industry standard for quality, reliability and ease-of-use features. It was the original modular-style series progressive divider valve and is still the best!

Baseplate Assemblies

Pre-assembled and tested base plates now available!
Make your parts list shorter and assembly quicker.

Easily Accessorized

Accessories such as cycle indicating proximity switches provide positive assurance of a successful lube event.

Built-In Outlet Check Valves

Ensure accurate lube delivery, every time.

Quick Change Valve Sections

Easily removed from the base assembly without disturbing any lube lines.

Indicator Ports

Alternate outlets on face of each valve can be fitted with optional performance indicators, taking the guesswork out of troubleshooting.

Fluid Flexibility

Use the same MSP components for oil or grease applications, reducing the number of parts that need to be stocked.

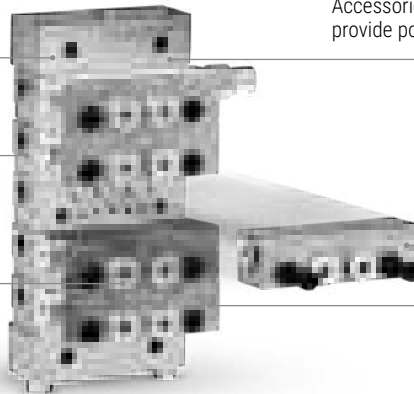

TYPICAL APPLICATIONS

- Mobile, industrial, food and beverage, wind and many more

TYPICAL FLUIDS

- Oil or Grease up to NLGI #2

TECHNICAL SPECIFICATIONS

Material	Plated Steel
Maximum Pressure	3,500 psi (241 bar)
Max Operating Temperature	350°F (176 °C)
Max Cycle Rate with Cycle Pin	60 cycles/minute
Max Cycle Rate without Cycle Pin	200 cycles/minute
Instruction Manual	312497



STEPS TO BUILD YOUR MSP DIVIDER VALVE SYSTEM:

A Select the Base Plate Assembly by the Number of Valve Sections Needed

B Select Valve Working Sections



Choose from Optional Accessories

- C** Cross-port and Singling Bars
- D** Performance Indicators
- E** Cycle Indicators and Proximity Switches
- F** Mounting Bars and Brackets
- G** Modular Specialty Inlets

A ORDERING OPTIONS

FACTORY-TESTED MSP BASE PLATE ASSEMBLIES

How many valve sections are in the assembly? Count up the number of sections and order a base assembly that has the correct number of sections. Base plate assembly is delivered completely assembled and tested with inlet, intermediate base plate sections, end section, tie rods and nuts.

Item	Maximum Number of Outlets	Number of Valve Sections	Part Number	
			NPSF	BSPP
1/2/3/4/5	6	3	24G485	24N915
	8	4	24G486	24N916
	10	5	24G487	24N917
	12	6	24G488	24N918
	14	7	24G489	24N919
	16	8	24G490	24N920

TRABON® MSP DIVIDER VALVE

A ORDERING OPTIONS (CONTINUED)

BUILD YOUR OWN MSP BASE PLATE ASSEMBLIES

Item	Component	Description	Part Number			Note
			NPSF	BSPP	SAE-ORB	
1	Inlet section options See page 140 for Zero Leak and Shunt inlet section options	Standard "MS" inlet section	560919	560936	560943	Must be ordered in multiples of 5.
		"MH" inlet with bleed ports	563421	N/A	563422	
2	Intermediate base plate	Two outlet ports	563425	563447	563451	
3	End section options	Standard end	563424			
		With alternate inlet port*	563279			
4	Tie Rods (3 required)	3-section	557731			3 tie rods and tie rod nuts required for assembly.
		4-section	557732			
		5-section	557733			
		6-section	557734			
		7-section	557735			
		8-section	557736			
		9-section	557738			
5	Tie Rod Nuts (3 required)	Tie rod nuts	556371			

*Alternate inlet port requires Leak Proof Zerk fitting such as part number 555888, 556429 or similar.

LEGEND

1	Inlet Section
2	Intermediate Base Plate Section / Subplate
3	End Section
4	Tie Rod
5	Tie Rod Nut
6	MSP Valve Section
7	Outlet Port Plug
8	Cross-port or Singling Bar
9	Performance Indicator

MSP SECTION SPARE PARTS

Part Number	Description
122276*	Standard O-ring (90 DURO Fluoroelastomer), black
556540*	Alternate O-ring (70 DURO Buna-N), black
557721*	MSV O-ring (70 DURO Fluoroelastomer), brown
563929	Cycle Indicator Pin Repair Kit
556327	Outlet Check Ball
557508	Outlet Check Spring, NPSF and BSPP bases
556994	Outlet Check Spring, SAE-ORB bases

*Part numbers are for a single O-ring; each section requires nine O-rings.

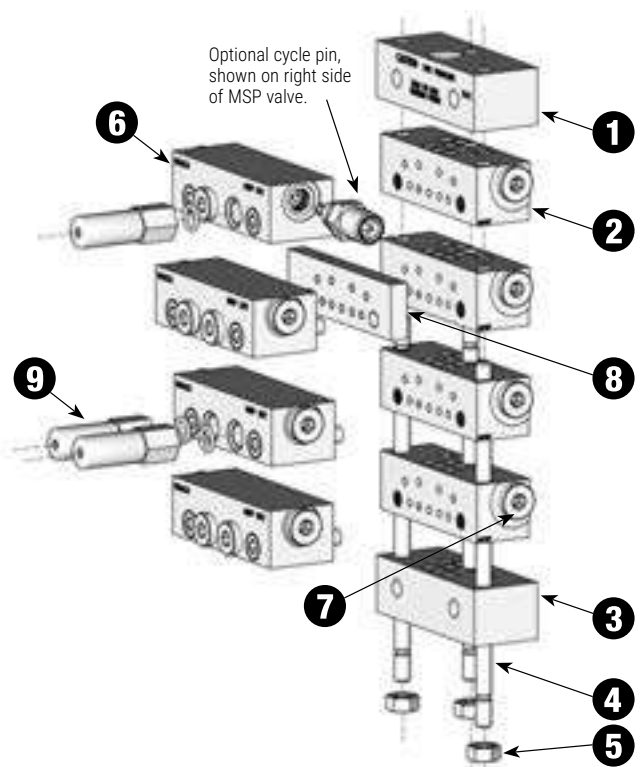



B ORDERING OPTIONS

MSP VALVE SECTIONS

Also called "Working" sections. Must be ordered in multiples of 5.

Outlet Configuration	Description	Output Per Outlet, in ³ (cm ³)	Part Number	
			Standard Section	With Cycle Pin
Single	MSP-5S*	0.010 (0.16)	562711	N/A
	MSP-10S*	0.020 (0.33)	562712	
	MSP-15S*	0.030 (0.49)	562713	
	MSP-20S*	0.040 (0.66)	562714	562729
	MSP-25S*	0.050 (0.82)	562715	562730
	MSP-30S*	0.060 (0.98)	562716	562731
	MSP-35S*	0.070 (1.15)	562717	562732
	MSP-40S*	0.080 (1.31)	562718	562733
Twin	MSP-5T	0.005 (0.08)	562720	N/A
	MSP-10T	0.010 (0.16)	562721	
	MSP-15T	0.015 (0.26)	562722	
	MSP-20T	0.020 (0.33)	562723	562739
	MSP-25T	0.025 (0.41)	562724	562740
	MSP-30T	0.030 (0.49)	562725	562741
	MSP-35T	0.035 (0.57)	562726	562742
	MSP-40T	0.040 (0.66)	562727	562743

*Each "S" section uses only one outlet, but each intermediate base has two outlets. For each "S" section in the assembly, order one Outlet Port Plug (below), to plug the unused outlet.

OUTLET PORT PLUGS

Part Number			Note
NPSF	BSPP	SAE-ORB	
557349 (NPT)	558799 (with seal ring)	567251 (with O-ring)	1 outlet port plug is required for each "S" valve section.

BYPASS SECTION

Part Number	Description
562660	MSP-BP Bypass Block takes the place of a valve, but has no output. Not a true working section. Requires two outlet port plugs for the unused outlets.

C ORDERING OPTIONS

CROSS-PORT AND SINGLING BARS

Part Number	Component	Note
563469	Right Cross-port Bar	1 outlet port plug is required for each cross-port bar, to plug the unused outlet.
563470	Left Cross-port Bar	
563471	Right and Left Cross-port Bar	2 outlet port plugs are required for each double cross-port bar.
563472	Singling Bar	Converts a "T" valve to an "S" valve.

TRABON® MSP DIVIDER VALVE

D ORDERING OPTIONS

PERFORMANCE INDICATORS

These vital safeguards react to excess lube pressure when points or lines become blocked. Installed in indicator ports on the working piston sections, they quickly identify the affected lines.

RESET INDICATORS WITH MEMORY

Features and Benefits

- Provides quick troubleshooting tool with visual indication
- No tools for reset or parts to replace after indication
- Easy information on blocked lines, high system pressure or blocked bearings
- 1/8 in NPSF thread with O-ring seal

	Part Number	Cracking Pressure
Image Coming Soon	563252	250 psi (17 bar)
	563253	500 psi (35 bar)
	563254	750 psi (52 bar)
	563255	1,000 psi (69 bar)
	563256	1,500 psi (103 bar)
	563257	2,000 psi (138 bar)
	563258	2,500 psi (172 bar)
	563261	3,000 psi (207 bar)
	563263	3,500 psi (241 bar)

AUTOMATIC RELIEF INDICATORS

Features and Benefits

These performance indicators pinpoint lube line blockages but allow the lube system to continue to supply lubrication to points that are not blocked.

- Allows machine to continue to run when non-critical bearings are blocked
- No time or effort required for reset after blockage is cleared
- Easy information on blocked lines, high system pressure or blocked bearings
- 1/8 in NPSF thread with O-ring seal

	Part Number	Cracking Pressure
	563170	750 psi (52 bar)
	563171	1,000 psi (69 bar)
	563172	1,250 psi (86 bar)
	563173	1,500 psi (103 bar)
	563174	2,000 psi (138 bar)
	563175	2,500 psi (172 bar)
	563176	3,000 psi (207 bar)

PERFORMANCE INDICATOR SPARE PARTS



Part Number	Description
556569	Standard O-ring (90 DURO Fluoroelastomer), black
556567	Alternate O-ring (90 DURO Buna-N), black
16U217	Indicator Port Plug, with O-ring 556569



E ORDERING OPTIONS

CYCLE INDICATORS AND PROXIMITY SWITCHES

A wide variety of safeguards to monitor and verify lube cycles. These mechanical and electrical units sense the divider valve piston's action for accurate control and monitoring of lube cycles.

	Part Number	Component	Description
	563251	Magnetic Visual Cycle Indicator	The highly visible cycle indicator has a snap-action movement which allows the user to visually determine the timing of each divider valve cycle.
	563272	SPDT Cycle Switch, provides electrical signal to controller or PLC	Used in conjunction with the cycle indicator pin at cycle rates not exceeding 60 cpm, it provides an electrical signal to the system controller which counts cycles to monitor and verify completion of the lube cycle.
	564357	Double Pole, Double Throw (DPDT) Cycle Switch and bracket assembly	
Image Coming Soon	563273	SPDT Cycle Switch, provides electrical signal to controller or PLC, moisture resistant	
	17L983	Solid State Proximity Switch (see page 161 for mating cables)	This rugged switch has no moving parts, making it ideal for applications such as metal stamping presses and yellow iron equipment. 10-32 VDC PNP switching, M12 electrical connector, 200 cpm, 7,500 PSI (518 bar) maximum pressure. 50,000,000 cycle life, IP65, IP68, IP69 rated.
Image Coming Soon	557741	Field-Sensitive Proximity Switch, 3-Pin BH, with O-ring	A ceramic-magnet switch for grease or oil systems up to 200 cpm at pressure up to 3,500 psi (241 bar), accurately signals piston cycles, and is ideal for high-cycle applications. Bradley-Harrison (BH) electrical connectors, 115 VAC. 7/16-20 thread with O-ring seal mates to MSP valves with date codes L94 and newer.
	557746	Field-Sensitive Proximity Switch, 5-Pin BH, with O-ring	

PROXIMITY SWITCH SPARE PARTS

Part Number	Description
556570	Standard O-ring (90 DURO Fluoroelastomer), black
556568	Alternate O-ring (90 DURO Buna-N), black
567251	Enclosure Port Plug, with O-ring 556570

F ORDERING OPTIONS

MOUNTING BARS

Part Number	Component	Description
560920	MSP/MHH Weld Bar	1/2 in (12.7 mm) thick steel bars are designed for welding to uneven metal surfaces. Mounting holes are threaded 1/4-20 to attach MSP or MHH valve assembly.
563465	Divider Valve Weld Bar Kit	Includes 2 mounting bars (560920), 4 screws, washers and lockwashers.

TOOL

Part Number	Component	Description
17J423	MSP/MHH Weld Stud Fixture	Attach studs to the jig before welding to ensure perfect alignment. For 3-valve to 8-valve assemblies

TRABON® MSP DIVIDER VALVE

G ORDERING OPTIONS

MSP MODULAR SPECIALTY INLETS

SHUNT INLETS

NEW – Graco has updated the Shunt Valve power connection to a DIN Connector. Previous versions used a 3-Pin Brad Harrison Connector. Adapter kit 25T585 (see below) is available to convert from 3-Pin BH to DIN.

Features and Benefits

- For use with oil and FLUID grease only – 3,500 psi maximum fluid pressure
- A three-way valve, incorporated into the MSP inlet section – can replace standard inlet or mount in-line with remote manifold kit.
- Options for 115 VAC, 24 VDC or pneumatic
- "Normal" state allows lubricant to enter divider valve
- Energized state sends fluid out the bypass port – to another divider valve, to a large bearing or back to tank.

Image Coming Soon	Power	Connection	Normal State	Shunt Inlet Part Number			Replacement Solenoids**
				Connection Thread			
				NPSF	BSPP	SAE-ORB	
	115 VAC	DIN	NO	25B534	–	25U054	20A339
	115 VAC	DIN	NC	25B535	–	25U053	
	24 VDC	DIN	NO	25B515	25U041	25U052	20A081
	24 VDC	DIN	NC	25B514	25U040	25U051	
	Pneumatic	1/8 NPSF*	NC*	563456	–	–	–

*Pneumatic Shunt 563456 ships in Normally Closed configuration, can be converted to Normally Open in the field. Air pressure range 40 to 150 psi, 1/8 in NPSF female air inlet port.

**Replacement Solenoids will NOT work in the old-style Shunt Inlets. If the coil or solenoid in an old style Inlet section has failed, replace the entire Inlet section.

ZERO-LEAK SHUT-OFF INLETS

NEW – Graco has updated the Zero-Leak Shut-Off Valve power connection to a DIN Connector. Previous versions used a 3-Pin Brad Harrison Connector. Adapter kit 25T585 (see below) is available to convert from 3-Pin BH to DIN.

Features and Benefits

- For use with oil only – 1,500 psi maximum oil pressure
- A two-way valve that can be used with either continuous or intermittent pressurized header systems.
- Replaces a standard inlet section or mounts in-line with a remote manifold kit.
- All models are Normally Closed

Image Coming Soon	Power	Connection	Normal State	Zero Leak Inlet Part Number			Replacement Solenoids**
				Connection Thread			
				NPSF	BSPP	SAE-ORB	
	115 VAC	DIN	NC	20A900	–	20A901	20A586
	24 VDC	DIN	NC	20A903	20A902	20A904	20A585
	Inlet restrictor with 90 micron last chance filter			563074	–	–	–

**Replacement Solenoids will NOT work in the old-style Zero-Leak Shut-Off Inlets. If the coil or solenoid in an old style Inlet section has failed, replace the entire Inlet section.

OTHER COMPONENTS FOR SHUNT AND ZERO-LEAK SHUT-OFF INLETS

CONNECTOR AND CABLE OPTIONS

	Part Number	Description
	2007482	Power cable with DIN connector, 15 ft (4.5 m).
	132924	Field-installable DIN connector, no wire provided.
	25T585	Adapter Cable Kit, 3-Pin BH to DIN. To be used on retrofits. Some assembly required. Instruction Manual number 3A8068.

REMOTE MOUNT MANIFOLD KIT

Part Number	Description
563461	Includes manifold with 1/4 NPSF outlet, O-ring 556540 and two mounting screws.

TRABON[®] MSP STAINLESS STEEL DIVIDER VALVE



SETTING THE INDUSTRY STANDARD FOR QUALITY, RELIABILITY AND EASE-OF-USE FEATURES

More durability with the same high-quality performance and precision machining as the carbon steel version. The stainless steel MSP valves and accessories overcome harsh conditions, such as salty air or areas needing repetitive cleaning, with durable 303 materials and a design with proven success.

Baseplate Assemblies

Pre-assembled and tested base plates now available! Make your parts list shorter and assembly quicker.

Built-In Outlet Check Valves

Ensure accurate lube delivery, every time.

Indicator Ports

Alternate outlets on face of each valve can be fitted with optional performance indicators, taking the guesswork out of troubleshooting.



Easily Accessorized

Accessories such as cycle indicating proximity switches provide positive assurance of a successful lube event.

Quick Change Valve Sections

Easily removed from the base assembly without disturbing any lube lines.

Fluid Flexibility

Use the same MSP components for oil or grease applications, reducing the number of parts that need to be stocked.

TYPICAL APPLICATIONS

- Food and beverage, machine tools, textile, glass and can machinery, mobile equipment

TYPICAL FLUIDS

- Oil or Grease up to NLGI #2

TECHNICAL SPECIFICATIONS

External Material	Stainless Steel
Internal Material	Carbon Steel
Maximum Pressure	3,500 psi (241 bar)
Max Operating Temperature	140°F (60°C)
Max Cycle Rate without Cycle Pin	200 cycles/minute
Instruction Manual	312497

TRABON® MSP STAINLESS STEEL DIVIDER VALVE

STEPS TO BUILD YOUR MSP STAINLESS STEEL DIVIDER VALVE SYSTEM:

A Select the Base Plate Assembly by the Number of Valve Sections Needed

B Select Valve Working Sections



Choose from Optional Accessories

C Cross-port and Singling Bars

D Performance Indicators

E Cycle Indicators and Proximity Switches

A ORDERING OPTIONS

FACTORY-TESTED MSP BASE PLATE ASSEMBLIES

How many valve sections are in the assembly? Count up the number of sections and order a base assembly that has the correct number of sections. Base plate assembly is delivered completely assembled and tested with inlets, intermediate base plate sections, end section, tie rods and nuts.

Item	Maximum Number of Outlets	Number of Valve Sections	Part Number	
			NPSF	BSPP
1/2/3/4/5	6	3	24N382	24N388
	8	4	24N383	24N389
	10	5	24N384	24N390
	12	6	24N385	24N391
	14	7	24N386	24N392



A ORDERING OPTIONS (CONTINUED)

BUILD YOUR OWN MSP BASE PLATE ASSEMBLIES

Item	Component	Description	Part Number		Note
			NPSF	BSPP	
1	303 stainless steel inlet section		15Y070	16P368	Must be ordered in multiples of 5
2	303 stainless steel intermediate base plate – with two outlet ports		24B497	24N369	
3	303 stainless steel end section		24B498		
4	416 stainless steel tie rods (3 required)	3-section	126247		3 tie rods and tie rod nuts required for assembly
		4-section	126248		
		5-section	126249		
		6-section	126250		
		7-section	126251		
5	Tie rod nuts (3 required)	Tie rod nuts	558633		

LEGEND

1	Inlet Section
2	Intermediate Base Section / Subplate
3	End Section
4	Tie Rod
5	Tie Rod Nut
6	MSP Valve Section
7	Outlet Port Plug
8	Cross-port or Singling Bar
9	Performance Indicator

MSP SECTION SPARE PARTS

Part Number	Description
122276*	Standard O-ring (90 DURO Fluoroelastomer), black
556540*	Alternate O-ring (70 DURO Buna-N), black
556327	Outlet Check Ball
557508	Outlet Check Spring

*Part numbers are for a single O-ring; each section requires nine O-rings.

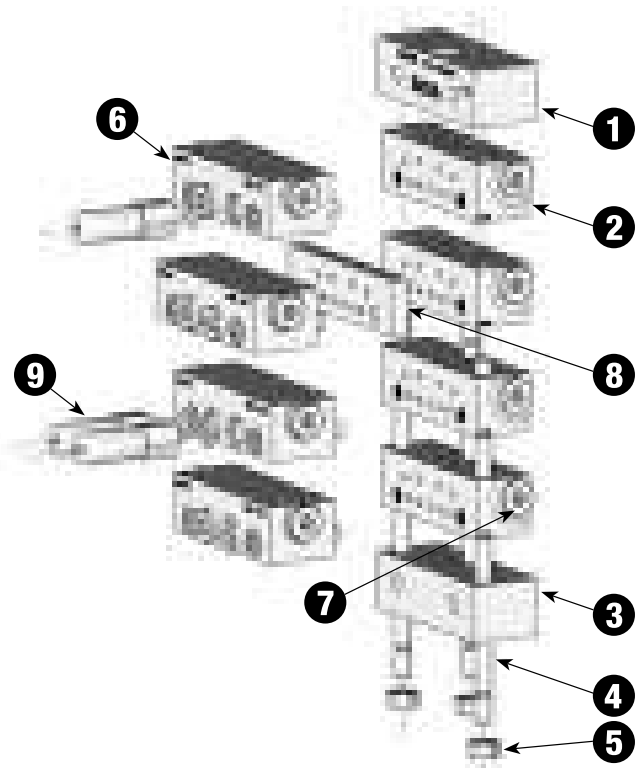

TRABON® MSP STAINLESS STEEL DIVIDER VALVE

B ORDERING OPTIONS

MSP VALVE SECTIONS – 303 STAINLESS STEEL

Also called "Working" sections. Must be ordered in multiples of 5.

Outlet Configuration	Description	Output Per Outlet, in ³ (cm ³)	Part Number
			Standard Section
Single	MSP-5S*	0.010 (0.16)	24B474
	MSP-10S*	0.020 (0.33)	562755
	MSP-15S*	0.030 (0.49)	24B475
	MSP-20S*	0.040 (0.66)	562756
	MSP-25S*	0.050 (0.82)	24B476
	MSP-30S*	0.060 (0.98)	24B477
	MSP-35S*	0.070 (1.15)	24B478
	MSP-40S*	0.080 (1.31)	562757
Twin	MSP-5T	0.005 (0.08)	24B479
	MSP-10T	0.010 (0.16)	562758
	MSP-15T	0.015 (0.26)	24B480
	MSP-20T	0.020 (0.33)	562759
	MSP-25T	0.025 (0.41)	24B481
	MSP-30T	0.030 (0.49)	24B482
	MSP-35T	0.035 (0.57)	24B483
	MSP-40T	0.040 (0.66)	562760

*Each "S" section uses only one outlet, but each intermediate base has two outlets. For each "S" section in the assembly, order one Outlet Port Plug (below), to plug the unused outlet.

316 STAINLESS STEEL OUTLET PORT PLUGS

Part Number		Note
NPSF	BSPP	
555457 (NPT)	114172 (BSPT)	1 outlet port plug is required for each "S" valve section

C ORDERING OPTIONS

CROSS-PORT AND SINGLING BARS – 303 STAINLESS STEEL

Part Number	Component	Note
24R632	Right Cross-port Bar	1 outlet port plug is required for each cross-port bar
24R633	Left Cross-port Bar	
24R631	Right and Left Cross-port Bar	2 outlet port plugs are required for each double cross-port bar



D ORDERING OPTIONS

Performance Indicators

These vital safeguards react to excess lube pressure when points or lines become blocked. Installed in indicator ports on the working piston sections, they quickly identify the affected lines.

RESET INDICATORS WITH MEMORY

Features and Benefits

- Provides quick troubleshooting tool with visual indication
- No tools for reset or parts to replace after indication
- Easy information on blocked lines, high system pressure or blocked bearings
- 1/8 NPSF thread with O-ring seal
- 303 Stainless Steel

Image Coming Soon	Part Number	Cracking Pressure
	24B495	1,000 psi (69 bar)
	24B496	1,500 psi (103 bar)
	24N373	2,000 psi (138 bar)

AUTOMATIC RELIEF INDICATORS

Features and Benefits

These performance indicators pinpoint lube line blockages but allow the lube system to continue to supply lubrication to points that are not blocked.

- Allows machine to continue to run when non-critical bearings are blocked
- No time or effort required for reset after blockage is cleared
- Easy information on blocked lines, high system pressure or blocked bearings
- 1/8 NPSF thread with O-ring seal
- 303 Stainless Steel

	Part Number	Cracking Pressure
	24N945	1,000 psi (69 bar)
	24N948	1,500 psi (103 bar)
	24N949	2,000 psi (138 bar)
	24N951	2,500 psi (172 bar)
	24N952	3,000 psi (207 bar)

PERFORMANCE INDICATOR SPARE PARTS

Part Number	Description
556569	Standard O-ring (90 DURO Fluoroelastomer), black
556567	Alternate O-ring (90 DURO Buna-N), black
19B227	Indicator Port Plug, 303 stainless steel with O-ring 556569

TRABON® MSP STAINLESS STEEL DIVIDER VALVE

E ORDERING OPTIONS

CYCLE INDICATORS AND PROXIMITY SWITCHES

A wide variety of safeguards to monitor and verify lube cycles. These mechanical and electrical units sense the divider valve piston's action for accurate control and monitoring of lube cycles.

	Part Number	Component	Description
	563251	Magnetic Visual Cycle Indicator	The highly visible cycle indicator has a snap-action movement which allows the user to visually determine the timing of each divider valve cycle.
	17L983	Solid State Proximity Switch (see page 161 for mating cables)	This rugged switch has no moving parts, making it ideal for applications such as metal stamping presses and yellow iron equipment. 10-32 VDC PNP switching, M12 electrical connector, 200 cpm, 7,500 PSI (518 bar) maximum pressure. 50,000,000 cycle life, IP65, IP68, IP69 rated.
	557741	Field-Sensitive Proximity Switch, 3-Pin BH, with O-ring	A ceramic-magnet switch for grease or oil systems up to 200 cpm at pressure up to 3,500 psi (241 bar), accurately signals piston cycles, and is ideal for high-cycle applications. Bradley-Harrison (BH) electrical connectors, 115 VAC.
	557746	Field-Sensitive Proximity Switch, 5-Pin BH, with O-ring	

PROXIMITY SWITCH SPARE PARTS

Part Number	Description
556570	Standard O-ring (90 DURO Fluoroelastomer), black
556568	Alternate O-ring (90 DURO Buna-N), black
19A574	Enclosure Port Plug, 303 stainless steel with O-ring 556570



MANZEL® MHH DIVIDER VALVE

MODULAR DESIGN FOR EASY MAINTENANCE

Same capable design as the Trabon MSP Series with even tighter and more exacting tolerances. The Manzel MHH Series delivers highly accurate lube delivery for demanding high-pressure oil applications.

Baseplate Assemblies

Pre-assembled and tested base plates now available! Make your parts list shorter and assembly quicker.



Quick Change Valve Sections

Easily removed from the base assembly without disturbing any lube lines – minimizing labor cost and maximizing your machine uptime.

Easily Accessorized

Accessories such as cycle indicating proximity switches provide positive assurance of a successful lube event.

Built-In Outlet Check Valves

Ensure accurate lube delivery, every time.

Indicator Ports

Alternate outlets on face of each valve can be fitted with optional performance indicators, taking the guesswork out of troubleshooting.

TYPICAL APPLICATIONS

- Compressors, industrial equipment, and where high-pressure lubrication is required

TYPICAL FLUIDS

- Synthetic or Mineral Oil

TECHNICAL SPECIFICATIONS

Material	Plated Steel
Maximum Pressure	7,500 psi (517 bar)
Maximum Operating Temperature	350°F (176°C)
Maximum Cycle Rate	200 cycles/min
Instruction Manual	312497

MANZEL[®] MHH DIVIDER VALVE

STEPS TO BUILD YOUR MHH DIVIDER VALVE SYSTEM:

A Select the Base Plate Assembly by the Number of Valve Sections Needed

B Select Valve Working Sections

Choose from Optional Accessories

C Cycle Indicators and Proximity Switches

D Performance Indicators

E Mounting Bars and Brackets



SERIES PROGRESSIVE

A ORDERING OPTIONS

FACTORY-TESTED MHH BASE PLATE ASSEMBLIES

How many sections are in the assembly? Count up the number of sections, and order a base assembly that has the correct number of sections. Base plate assembly is delivered completely assembled and tested with inlets, intermediate base plate sections, end section, tie rods and nuts.

Item	Maximum Number of Outlets	Number of Valve Sections	Part Number
			NPSF
1/2/3/4/5	6	3	24F596
	8	4	24F597
	10	5	24F598
	12	6	24F599
	14	7	24F600
	16	8	24F601



A ORDERING OPTIONS (CONTINUED)

BUILD YOUR OWN MHH BASE PLATE ASSEMBLIES

Item	Component	Description	Part Number	Note	
			NPSF		
1	Inlet section options	"MH" inlet with bleed ports	563421	Must be ordered in multiples of 5	
		"MS" inlet without bleed ports	560919		
2	Intermediate base plate	Two outlet ports	563425		
3	End section options plate	Standard end	563424		
		With alternate inlet port*	563279		
4	Tie Rods (3 required)	3-section	557731		3 tie rods and tie rod nuts required for assembly
		4-section	557732		
		5-section	557733		
		6-section	557734		
		7-section	557735		
		8-section	557736		
		9-section	557738		
10-section	557739				
11-section	557740				
5	Tie Rod Nuts (3 required)	Tie rod nuts	556371		

*Alternate inlet port in end section 563279 requires Leak Proof Zerk fitting such as part number 555888, 556429 or similar.
NOTE: Refer to MSP pages for BSPP and SAE inlet and base plate porting options.

LEGEND

1	Inlet Section
2	Intermediate Base Section / Subplate
3	End Section
4	Tie Rod
5	Tie Rod Nut
6	MSP Valve Section
7	Outlet Port Plug
9	Performance Indicator

MHH SECTION SPARE PARTS

Part Number	Description
122276*	Standard O-ring (90 DURO Fluoroelastomer), black
556540*	Alternate O-ring (70 DURO Buna-N), black
556327	Outlet check ball
557508	Outlet check spring

*Part numbers are for a single O-ring; each section requires nine O-rings.

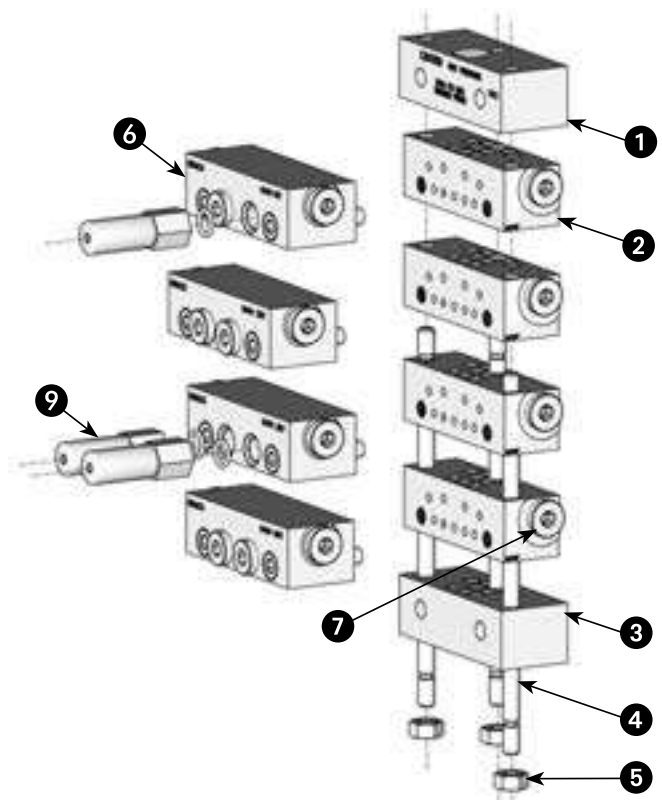

MANZEL® MHH DIVIDER VALVE

B ORDERING OPTIONS

MHH VALVE SECTIONS

Also called "Working" sections. Must be ordered in multiples of 5.

Outlet Configuration	Description	Output Per Outlet, in ³ (cm ³)	Part Number
			Standard Section
Single	MHH-6S*	0.012 (0.197)	562679
	MHH-9S*	0.018 (0.295)	562680
	MHH-12S*	0.024 (0.393)	562681
	MHH-15S*	0.030 (0.492)	24X029
	MHH-18S*	0.036 (0.590)	562682
	MHH-21S*	0.042 (0.688)	24X030
	MHH-24S*	0.048 (0.787)	562683
	MHH-30S*	0.060 (0.983)	562684
Twin	MHH-6T	0.006 (0.098)	562685
	MHH-9T	0.009 (0.149)	562686
	MHH-12T	0.012 (0.197)	562687
	MHH-15T	0.015 (0.246)	24X027
	MHH-18T	0.018 (0.295)	562688
	MHH-21T	0.021 (.0344)	24X028
	MHH-24T	0.024 (0.393)	562689
	MHH-30T	0.030 (0.492)	562690

*Each "S" section uses only one outlet, but each intermediate base has two outlets. For each "S" section in the assembly, order one of part number 557349 (1/8 in NPTF Outlet Port Plug) to plug the unused outlet.

C ORDERING OPTIONS

CYCLE INDICATORS AND PROXIMITY SWITCHES

	Part Number	Component	Note
	563251	Magnetic Visual Cycle Indicator	The highly visible cycle indicator has a snap-action movement which allows the user to visually determine the timing of each divider valve cycle.
Image Coming Soon	557745	Explosion-Proof FSmech Proximity Switch	Explosion-proof dry contact switch dual rated for 115 VAC or 10-32 VDC. Includes potted 6 ft (1.8 m) cable with flying leads. Used at pressures that do not exceed 7,500 psi (517 bar) at cycle rates up to 200 cycles per minute. Approved for hazardous locations: Class I, Groups A, B, C and D – Division 1.
Image Coming Soon	558941	Micro-Monitor	LCD shows total cycle count up to 999,999. Reset to zero by inserting the reset magnet into the recessed opening. An LED will also flash with each cycle of the piston in the divider block indicating a complete stroke.

PROXIMITY SWITCH SPARE PARTS

Part Number	Description
556570	Standard O-ring (90 DURO Fluoroelastomer), black
556568	Alternate O-ring (90 DURO Buna-N), black
567251	Enclosure Port Plug, with O-ring 556570



D ORDERING OPTIONS

PERFORMANCE INDICATORS

These vital safeguards react to excess lube pressure when points or lines become blocked. Installed in indicator ports on the working piston sections, they quickly identify the affected lines.

RESET INDICATORS WITH MEMORY

Features and Benefits

- Provides quick troubleshooting tool with visual indication
- No tools for reset or parts to replace after indication
- Easy information on blocked lines, high system pressure or blocked bearings
- 1/8 NPSF thread with O-ring seal

	Part Number	Cracking Pressure
Image Coming Soon	563258	2,500 psi (172 bar)
	563261	3,000 psi (207 bar)
	563263	3,500 psi (241 bar)
	563262	5,000 psi (345 bar)

DISK-TYPE PRESSURE INDICATOR

Features and Benefits

A blow-out disk ruptures when lube line blockage occurs and lubricant forces a pin to protrude from the body of the indicator. There is no provision for relief and the pressure escalates until relieved elsewhere in the system. The disk must be replaced and the pin reset manually after the blockage is eliminated.

- Easy information on blocked lines, high system pressure or blocked bearings
- 1/8 NPSF thread with O-ring seal

	Part Number	Cracking Pressure	Replacement Rupture Disks
	563229	2,800 psi (193 bar)	557422
	563221	3,700 psi (255 bar)	557423
	563222	4,600 psi (317 bar)	557424
	563224	5,500 psi (380 bar)	557425
	563226	6,400 psi (441 bar)	557427
	N/A	7,300 psi (503 bar)	557428
	N/A	8,200 psi (565 bar)	557429

PERFORMANCE INDICATOR SPARE PARTS

Part Number	Description
556569	Standard O-ring (90 DURO Fluoroelastomer), black
556567	Alternate O-ring (90 DURO Buna-N), black
16U217	Indicator Port Plug, with O-ring 556569

E ORDERING OPTIONS

"Manzel Mount" MHH valves have the same footprint as the Trabon MSP valves. Please refer to the MSP pages for mounting bar and bracket options available from Graco.

TRABON® MX DIVIDER VALVE

GREATER OUTPUT VOLUMES FOR HEAVY SERVICE REQUIREMENTS

The Trabon MX Series is ideal for steel and paper mill systems with its economical and compact design.

Durable Design

Withstands harsh environments and operating conditions.

Indicator Ports

Alternate outlets on face of each valve can be fitted with optional performance indicators, taking the guesswork out of troubleshooting.

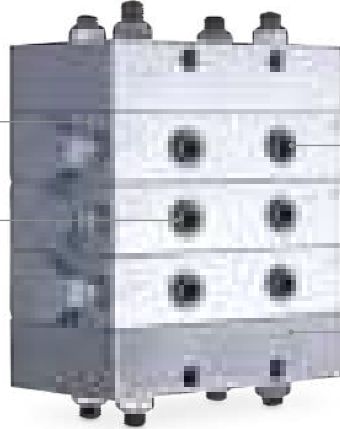

Easily Accessorized

Accessories such as proximity switch cycle indicators provide positive assurance of a successful lube event.

Built-In Outlet Check Valves

Ensure accurate lube delivery, every time.

TYPICAL APPLICATIONS

- Pulp and paper, steel mills, heavy- and high-volume industrial applications
- Please Note: MX valves are primarily offered for replacement of existing MX, MXS, and MXO valve assemblies. For new application, consider the MXP series instead.

TYPICAL FLUIDS

- Oil or Grease up to NLGI #2

TECHNICAL SPECIFICATIONS

Material	Plated Steel
Maximum Pressure	3,000 psi (207 bar)
Maximum Operating Temperature	200°F (93°C)
Maximum Cycle Rate with Cycle Pin	60 cycles/min
Instruction Manual	312497



STEPS TO BUILD YOUR MX DIVIDER VALVE SYSTEM:

A Select Valve Working Sections

B Select Inlet and End Sections

C Select Tie Rods and Tie Rod Nuts

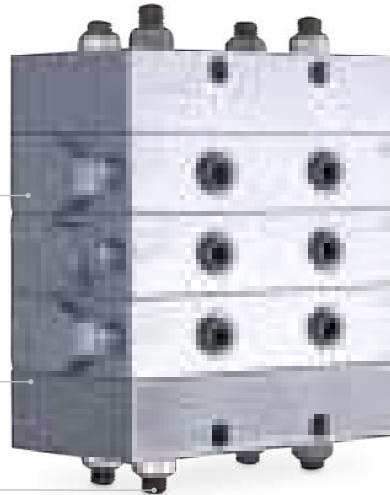

Choose from Optional Accessories

D Cross-port and Singling Bars

E Cycle Indicators and Proximity Switches

F Performance Indicators

G Mounting Bars

A ORDERING OPTIONS

VALVE WORKING SECTIONS

Must be ordered in multiples of two.

Outlet Configuration	Description	Output Per Outlet, in ³ (cm ³)	Part Number	
			Standard Section	With Cycle Pin – Right
Single	MX-25S	0.050 (0.82)	562514	N/A
	MX-50S	0.100 (1.64)	562516	562518
	MX-75S	0.150 (2.46)	562538	562519
	MX-100S	0.200 (3.28)	562540	562520
	MX-125S	0.250 (4.10)	562542	562521
	MX-150S	0.300 (4.92)	562545	562522
Twin	MX-25T	0.025 (0.41)	562515	N/A
	MX-50T	0.050 (0.82)	562517	562523
	MX-75T	0.075 (1.23)	562539	562524
	MX-100T	0.100 (1.64)	562541	562525
	MX-125T	0.125 (2.05)	562543	562526
	MX-150T	0.150 (2.46)	562546	562527

MX SPARE PARTS AND ACCESSORIES

Part Number	Description
563917	Cycle indicator repair kit
557509	Replacement intermediate gasket
557391	Replacement 1/4 in NPTF outlet port plug (one is already included with each "S" section)

TRABON® MX DIVIDER VALVE

B ORDERING OPTIONS

INLET AND END SECTIONS

Must be ordered in multiples of two.

Component	Description	Part Number
Inlet Section	Standard 3/8 in NPSF inlet, accepts NPT fittings	560620
End Section	Standard end section	563287

Note: Each valve, inlet and end section is packaged with a gasket, so a complete MX assembly will have one gasket leftover.

C ORDERING OPTIONS

TIE RODS AND TIE ROD NUTS

Four tie rods and eight tie rod nuts required for each MX assembly.

Component	Length	Part Number
Tie Rods (4 required)	3-section	557488
	4-section	557489
	5-section	557490
	6-section	557491
	7-section	557492
	8-section	557493
Tie Rod Nuts (8 required)	9-section	560576
	N/A	557494

D ORDERING OPTIONS

CROSS-PORT AND SINGLING BARS

For each bar used, order one of part number 557391 (1/4 in NPT pipe plug) to plug the unused outlet.

	Part Number	Component	Description
	562917	Right or Left Cross-port Bar	Provides a path to redirect output from one outlet to the next one below it, away from the inlet.
	562916	Singling Bar	Converts a "T" valve to an "S" valve

E ORDERING OPTIONS

CYCLE INDICATORS AND PROXIMITY SWITCHES

A wide variety of safeguards monitor and verify lube cycles. These switches sense the divider valve piston's action for accurate control and monitoring of lube cycles.

	Part Number	Component	Description
	563260	Magnetic Visual Cycle Indicator	The highly visible cycle indicator has a snap-action movement which allows the user to visually determine the timing of each divider valve cycle.
	563272	Single Pole, Double Throw (SPDT) Standard Cycle Switch and Bracket Assembly	Used in conjunction with the cycle indicator pin at cycle rates not exceeding 60 cpm, the switch provides an electrical signal to the system controller which counts cycles to monitor and verify completion of the lube cycle. Included bracket clamps to spud around cycle pin.
	563273	Moisture-resistant SPDT Cycle Switch and Bracket Assembly	
	564357	Double Pole, Double Throw (DPDT) Cycle Switch and Bracket Assembly	
	17L880	Solid State Proximity Switch (see page 161 for mating cables)	This rugged switch has no moving parts, making it ideal for applications such as metal stamping presses and yellow iron equipment. 10-32 VDC PNP switching, M12 electrical connector, 200 cpm, 7,500 PSI (518 bar) maximum pressure. 50,000,000 cycle life, IP65, IP68, IP69 rated.
	563476	Field-Sensitive Proximity Switch, 3-Pin BH, with O-ring	A ceramic-magnet switch for grease or oil systems up to 200 cpm at pressure up to 3,500 psi (241 bar), accurately signals piston cycles, and is ideal for high-cycle applications. Bradley-Harrison (BH) electrical connectors, 115 VAC.
	564399	Field-Sensitive Proximity Switch, 5-Pin BH, with O-ring	



F ORDERING OPTIONS

PERFORMANCE INDICATORS

These vital safeguards react to excess lube pressure when points or lines become blocked. Installed in indicator ports on the working piston sections, they quickly identify the affected lines. 1/4 in NPT male thread installs in the indicator ports on the front of each valve.

RESET INDICATORS WITH MEMORY

Features and Benefits

- Provides quick troubleshooting tool with visual indication
- No tools for reset or parts to replace after indication
- Easy information on blocked lines, high system pressure or blocked bearings
- 1/4 in NPTF thread

	Part Number	Indication Pressure
	563239	250 psi (17 bar)
	563240	500 psi (35 bar)
	563241	750 psi (52 bar)
	563242	1,000 psi (69 bar)
	563243	1,500 psi (103 bar)
	563244	2,000 psi (138 bar)
	563245	2,500 psi (172 bar)

AUTOMATIC RELIEF INDICATORS

These performance indicators pinpoint lube line blockages but allow the lube system to continue to supply lubrication to points that are not blocked.

Features and Benefits

- Allows machine to continue to run while non-critical bearings are lubricated
- No time or effort required for reset after blockage is cleared
- Easy information on blocked lines, high system pressure or blocked bearings
- 1/4 in NPTF thread

	Part Number	Indication Pressure
	563156	750 psi (52 bar)
	563157	1,000 psi (69 bar)
	563158	1,250 psi (86 bar)
	563159	1,500 psi (103 bar)
	563160	2,000 psi (138 bar)
	563161	3,000 psi (207 bar)

G ORDERING OPTIONS

MOUNTING BARS

Part Number	Component	Description
561102	MX/MXP Mounting Bar	For welding to uneven metal surfaces. Two sets of mounting holes are threaded 5/16-18 to attach MXP or MX. This part is one individual bar, so order quantity 2 when needed.

TRABON® MXP DIVIDER VALVE

MODULAR VERSION OF MX VALVES – SAME FUNCTION, BUT MODERN DESIGN.

The “big brother” of the MSP. Uses same performance indicators as MSP!

Built-In Outlet Check Valves

Ensure accurate lube delivery, every time.

Indicator Ports

Alternate outlets on face of each valve can be fitted with optional performance indicators, taking the guesswork out of troubleshooting.



Easily Accessorized

Accessories such as proximity switch cycle indicators provide positive assurance of a successful lube event.

Quick Change Valve Sections

Easily removed from the base assembly without disturbing any lube lines.

TYPICAL APPLICATIONS

- Pulp and paper, steel mills, heavy- and high-volume industrial applications

TYPICAL FLUIDS

- Oil or Grease up to NLGI #2

TECHNICAL SPECIFICATIONS

Material	Plated Steel
Maximum Pressure	3,000 psi (207 bar)
Maximum Operating Temperature	350°F (176°C)
Maximum Cycle Rate with Cycle Pin	60 cycles/min
Maximum Cycle Rate without Cycle Pin	110-200 cycles/min (see chart below)
Instruction Manuals	312497

MXP MAXIMUM CYCLE RATES WITHOUT CYCLE PIN (CYCLES/MIN)

		Number of Sections							
		3	4	5	6	7	8	9	10
Smallest Piston in the Assembly	MXP-150	200	200	200	200	200	200	180	165
	MXP-125	200	200	200	200	200	195	175	155
	MXP-100	200	200	200	200	200	185	165	150
	MXP-75	200	200	200	200	200	175	155	140
	MXP-50	200	200	200	200	195	165	145	130
	MXP-25	200	200	200	200	165	140	125	120



STEPS TO BUILD YOUR MXP DIVIDER VALVE SYSTEM:

A Build Your Base Plate Assembly from the Chart Below

B Select Valve Working Sections



Choose from Optional Accessories

- C** Cross-port and Singling Bars
- D** Performance Indicators
- E** Cycle Indicators and Proximity Switches
- F** Mounting Bars

A ORDERING OPTIONS

BUILD YOUR OWN MXP BASE PLATE ASSEMBLIES

How many sections are in the assembly? This includes working sections and bypass blocks. Count up the number of sections and order at least one Intermediate Base Plate for each section. Then add one Inlet and one End section. Finally choose the correct tie rods and order three of them and also three nuts.

Item	Component	Description	Part Number			Note
			NPSF	BSPP	SAE-ORB	
1	Inlet section option	Includes one threaded port	15R993 (3/8-18)	561029 (3/8-19)	15R994 (3/4-16)	
2	Intermediate base plate	Standard base with outlet checks	563519 (1/4-18)	563522 (1/4-19)	563521 (9/16-18)	Must be ordered in multiples of 5
		"MXPO" base, no outlet checks	563527	24Z675	N/A	
3	End section options	Standard	563518			
4	Tie rods (3 required)	3-section	557766			3 tie rods and tie rod nuts required for assembly
		4-section	557767			
		5-section	557768			
		6-section	557769			
		7-section	557770			
		8-section	557771			
		9-section	557772			
10-section	563520					
5	Tie rod nuts (3 required)	Tie rod nuts	555406			

LEGEND

1	Inlet Section
2	Intermediate Base Section / Subplate
3	End Section
4	Tie Rod
5	Tie Rod Nut
6	MXP Valve Section
7	Outlet Port Plug
8	Cross-port or Singling Bar
9	Performance Indicator

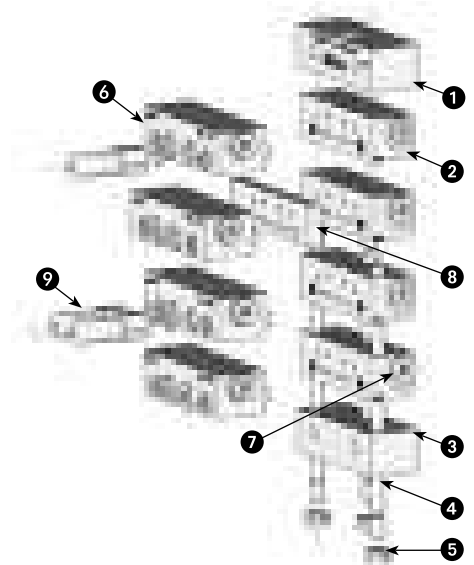

MXP SECTION SPARE PARTS

Part Number	Description
115010*	Standard O-ring (90 DURO Fluoroelastomer), black
563917	Cycle indicator pin repair kit
556328	Outlet check ball
557484	Outlet check spring, NPSF and BSPP bases
556997	Outlet check spring, SAE-ORB bases

*Part numbers are for a single O-ring; each section requires nine O-rings.

TRABON® MXP DIVIDER VALVE

B ORDERING OPTIONS

MXP VALVE SECTIONS

Also called "working" sections. Must be ordered in multiples of 2.

Outlet Configuration	Description	Output Per Outlet, in ³ (cm ³)	Part Number	
			Standard Section	With Cycle Pin – Right
Single	MXP-25S*	0.050 (0.82)	562819	N/A
	MXP-50S*	0.100 (1.64)	562820	562830
	MXP-75S*	0.150 (2.46)	562821	562831
	MXP-100S*	0.200 (3.28)	562822	562832
	MXP-125S*	0.250 (4.10)	562823	562833
	MXP-150S*	0.300 (4.92)	562824	562834
Twin	MXP-25T	0.025 (0.41)	562813	N/A
	MXP-50T	0.050 (0.82)	562814	562825
	MXP-75T	0.075 (1.23)	562815	562826
	MXP-100T	0.100 (1.64)	562816	562827
	MXP-125T	0.125 (2.05)	562817	562828
	MXP-150T	0.150 (2.46)	562818	562829

*Each "S" section uses only one outlet, but each intermediate base has two outlets. For each "S" section in the assembly, order one Outlet Port Plug (below), to plug the unused outlet.

OUTLET PORT PLUGS

Part Number		Note
NPSF	BSPP	
557391 (NPT)	556427 (with seal ring)	1 outlet port plug is required for each "S" valve section.

C ORDERING OPTIONS

CROSS-PORT AND SINGLING BARS

Part Number	Component	Note
563525	Right Cross-port Bar	1 outlet port plug is required for each cross-port bar
563524	Left Cross-port Bar	
563526	Right and Left Cross-port Bar	2 outlet port plugs are required for each double cross-port bar



D ORDERING OPTIONS

Performance Indicators

These vital safeguards react to excess lube pressure when points or lines become blocked. Installed in indicator ports on the working piston sections, they quickly identify the affected lines.

RESET INDICATORS WITH MEMORY

Features and Benefits

- Provides quick troubleshooting tool with visual indication
- No tools for reset or parts to replace after indication
- Easy information on blocked lines, high system pressure or blocked bearings
- 1/8 NPSF thread with O-ring seal

Image Coming Soon	Part Number	Cracking Pressure
	563252	250 psi (17 bar)
	563253	500 psi (35 bar)
	563254	750 psi (52 bar)
	563255	1,000 psi (69 bar)
	563256	1,500 psi (103 bar)
	563257	2,000 psi (138 bar)
	563258	2,500 psi (172 bar)
563261	3,000 psi (207 bar)	

AUTOMATIC RELIEF INDICATORS

Features and Benefits

These performance indicators pinpoint lube line blockages but allow the lube system to continue to supply lubrication to points that are not blocked.

- Allows machine to continue to run when non-critical bearings are blocked
- No time or effort required for reset after blockage is cleared
- Easy information on blocked lines, high system pressure or blocked bearings
- 1/8 NPSF thread with O-ring seal

	Part Number	Cracking Pressure
	563170	750 psi (52 bar)
	563171	1,000 psi (69 bar)
	563172	1,250 psi (86 bar)
	563173	1,500 psi (103 bar)
	563174	2,000 psi (138 bar)
	563175	2,500 psi (172 bar)
	563176	3,000 psi (207 bar)

PERFORMANCE INDICATOR SPARE PARTS

Part Number	Description
556569	Standard O-ring (90 DURO Fluoroelastomer), black
16U217	Indicator Port Plug, with O-ring 556569

TRABON® MXP DIVIDER VALVE

E ORDERING OPTIONS

CYCLE INDICATORS AND PROXIMITY SWITCHES

A wide variety of safeguards monitor and verify lube cycles. These switches sense the divider valve piston's action for accurate control and monitoring of lube cycles.

Part Number	Component	Description
563260	Magnetic Visual Cycle Indicator	The highly visible cycle indicator has a snap-action movement which allows the user to visually determine the timing of each divider valve cycle.
563272	Single Pole, Double Throw (SPDT) Standard Cycle Switch and Bracket Assembly	Used in conjunction with the cycle indicator pin at cycle rates not exceeding 60 cpm, the switch provides an electrical signal to the system controller which counts cycles to monitor and verify completion of the lube cycle. Included bracket clamps to spud around cycle pin.
563273	Moisture-resistant SPDT Cycle Switch and Bracket Assembly	
564357	Double Pole, Double Throw (DPDT) Cycle Switch and Bracket Assembly	
17L880	Solid State Proximity Switch (see page 161 for mating cables)	This rugged switch has no moving parts, making it ideal for applications such as metal stamping presses and yellow iron equipment. 10-32 VDC PNP switching, M12 electrical connector, 200 cpm, 7,500 PSI (518 bar) maximum pressure. 50,000,000 cycle life, IP65, IP68, IP69 rated.
563476	Field-Sensitive Proximity Switch, 3-Pin BH, with O-ring	A ceramic-magnet switch for grease or oil systems up to 200 cpm at pressure up to 3,500 psi (241 bar), accurately signals piston cycles, and is ideal for high-cycle applications. Bradley-Harrison (BH) electrical connectors, 115 VAC.
564399	Field-Sensitive Proximity Switch, 5-Pin BH, with O-ring	



PROXIMITY SWITCH SPARE PARTS

Part Number	Description
556572	Standard O-ring (90 DURO Fluoroelastomer), black
557774	Enclosure Port Plug, requires O-ring 556572 (not included)

F ORDERING OPTIONS

MOUNTING BARS

Part Number	Component	Description
561102	MXP/MX Mounting Bar	For welding to uneven metal surfaces. Two sets of mounting holes are threaded 5/16-18 to attach MXP or MX. This part is one individual bar, so order quantity 2 when needed.



TRABON® MGO DIVIDER VALVE

OFFERS THE LARGEST OUTPUT AVAILABLE IN A SERIES PROGRESSIVE SYSTEM

Ideal for heavy-duty and large bearing applications with wide temperature variations and high volume requirements. Can be easily accessorized with magnetic and electronic proximity switch cycle indicators to provide positive assurance of a successful lube event.



Indicator Ports

Alternate outlets on face of each valve can be fitted with optional performance indicators, taking the guesswork out of troubleshooting.

Robust Design

Is virtually indestructible and built to perform in extreme environments.

TYPICAL APPLICATIONS

- Pulp and paper, steel mills, heavy- and high-volume industrial applications

TYPICAL FLUIDS

- Oil or Grease up to NLGI #2

TECHNICAL SPECIFICATIONS

Material	Plated Steel
Maximum Pressure	6,000 psi (413 bar)
Maximum Operating Temperature	350°F (176°C)
Maximum Cycle Rate with Cycle Pin	60 cycles/min
Maximum Cycle Rate without Cycle Pin	110-200 cycles/min (see chart below)
Instruction Manual	312497

MGO MAXIMUM CYCLE RATES WITHOUT CYCLE PIN (CYCLES/MIN)

		Number of Sections							
		3	4	5	6	7	8	9	10
Smallest Piston in the Assembly	MGO-600	185	140	110	90	80	70	60	55
	MGO-450	185	135	110	90	75	65	60	50
	MGO-300	180	130	100	80	70	60	55	50
	MGO-150	180	125	100	80	65	55	50	45
	MXP-50	200	200	200	200	195	165	145	130
	MXP-25	200	200	200	200	165	140	125	120

TRABON® MGO DIVIDER VALVE

STEPS TO BUILD YOUR MGO DIVIDER VALVE SYSTEM:

A Select Valve Working Sections

B Select Inlet and End Sections



C Select Tie Rods and Tie Rod Nuts

Choose from Optional Accessories

D Cycle Indicating Switches

E Performance Indicators

SERIES PROGRESSIVE

A ORDERING OPTIONS

VALVE WORKING SECTIONS

Standard 7/8 in-14 SAE-ORB outlet ports.

Outlet Configuration	Description	Output Per Outlet, in ³ (cm ³)	Part Number	
			Standard Section	With Cycle Pin – Right
Single	MGO-150S	0.300 (4.92)	562570	562578
	MGO-300S	0.600 (9.83)	562571	562579
	MGO-450S	0.900 (14.7)	562572	562580
	MGO-600S	1.200 (19.7)	562573	562581
Twin	MGO-150T	0.150 (2.46)	562574	562582
	MGO-300T	0.300 (4.92)	562575	562583
	MGO-450T	0.450 (7.37)	562576	562584
	MGO-600T	0.600 (9.83)	562577	562585

MGO SPARE PARTS AND ACCESSORIES

Part Number	Description
563926	Replacement MGO section O-ring kit – 1 kit per section
556424	Replacement 7/8 in-14 SAE-ORB outlet port plug, with O-ring (one is already included with each "S" section)



B ORDERING OPTIONS

INLET AND END SECTIONS

Component	Description	Part Number
Inlet Section	Standard 7/8-14 SAE-ORB inlet	563277
End Section	Standard end section	563278

C ORDERING OPTIONS

TIE RODS AND TIE ROD NUTS

Four tie rods and eight tie rod nuts required for each MGO assembly.

Component	Length	Part Number
Short Tie Rods (2 required)	3-section	560591
	4-section	560592
	5-section	560593
	6-section	560594
	7-section	560595
	8-section	560596
	9-section	560597
Long Tie Rods (2 required)	3-section	560600
	4-section	560601
	5-section	560602
	6-section	560603
	7-section	15U857
	8-section	560604
	9-section	560605
Tie Rod Nuts (8 required)	N/A	557494

TRABON® MGO DIVIDER VALVE

D ORDERING OPTIONS

CYCLE INDICATING SWITCHES

A wide variety of safeguards monitor and verify lube cycles. These switches sense the divider valve piston's action for accurate control and monitoring of lube cycles.

	Part Number	Component	Description
	563269	SPDT Cycle Switch, provides electrical signal to controller or PLC	Used in conjunction with the cycle indicator pin at cycle rates not exceeding 60 cpm, it provides an electrical signal to the system controller which counts cycles to monitor and verify completion of the lube cycle.
	17L881	Solid State Proximity Switch (see page 161 for mating cables)	This rugged switch has no moving parts, making it ideal for applications such as metal stamping presses and yellow iron equipment. 10-32 VDC PNP switching, M12 electrical connector, 200 cpm, 6,000 PSI (518 bar) maximum pressure. 50,000,000 cycle life, IP65, IP68, IP69 rated.
	563970	Field-Sensitive Proximity Switch, 3-Pin BH, with O-ring, 3,500 psi (241 bar) maximum	A ceramic-magnet switch for grease or oil systems up to 200 cpm, accurately signals piston cycles, and is ideal for high-cycle applications. Bradley-Harrison (BH) electrical connectors, 115 VAC.
	564402	Field-Sensitive Proximity Switch, 5-Pin BH, with O-ring, 10,000 psi (690 bar) maximum	

E ORDERING OPTIONS

PERFORMANCE INDICATORS

These vital safeguards react to excess lube pressure when points or lines become blocked. Installed in indicator ports on the working piston sections, they quickly identify the affected lines.

RESET INDICATORS WITH MEMORY

Features and Benefits

- Provides quick troubleshooting tool with visual indication
- No tools for reset or parts to replace after indication
- Easy information on blocked lines, high system pressure or blocked bearings
- 7/8 in-14 SAE-ORB thread, with O-ring

Image Coming Soon	Part Number	Cracking Pressure
	564200	1,500 psi (103 bar)



PROXIMITY SWITCHES

SOLID STATE PNP PROXIMITY SWITCHES

Solid State switches use a transistor instead of moving parts, making them the most durable option. They are the first choice for all applications that run on DC power. Note: all G3 Max pumps run DC power on their cycle switches, even when the pumps are AC powered.

Stainless Steel Construction

IP65, IP68 and IP69 rated.

PNP Transistor

Eliminates moving parts for maximum durability.

M12 Electrical Connector

Mating cables are readily available with options for LED indication and NPN conversion.

Options for All Graco Trabon Valves

Mating threads for all valves including MSP, CSP and even MJ and MD!



TYPICAL APPLICATIONS

- Cycle Indication for Series Progressive Divider Valves
- Metal stamping, construction equipment, nearly any application with a Series Progressive Divider Valve
- A great match to the G3 Max and G-Mini Controller pumps

TYPICAL FLUIDS

- Oil or Grease up to NLGI #2

TECHNICAL SPECIFICATIONS

Material	Stainless Steel
Operating Voltage	9.6 - 32 VDC
Electrical Design	DC PNP
Max Operating Temperature	176°F (80 °C)
Switch state	Normally Open
Rated Life Cycles	50,000,000
Maximum Cycles per Minute	200
Approval or Classification	IP65, IP68, IP69
Instruction Manual	3A41444

ORDERING OPTIONS

SOLID STATE PROXIMITY SWITCHES

Part Number	Divider Valve Series	Maximum Pressure PSI (bar)
17L879	CSP	5,075 (350)
17M380	MD or MJ	3,000 (207)
17L983	MSP or MHH	7,500 (518)
17L880	MX or MXP	8,000 (552)
17L881	MGO	6,000 (414)

ADAPTER CABLES

Convert M12 to the various connections that have traditionally been offered on Trabon proximity switches. See Instruction Manual number 3A4481 for more information on adapter cables.

Part Number	Notes
24Z714	M12 to 5-pin BH cable also converts signal from PNP to NPN.
24Z715	M12 to 3-pin BH cable also converts signal from PNP to NPN.
24Z719	M12 to 4-pin CH cable; signal remains PNP

M12 WIRING HARNESES

Part Number	Proximity Switch Connection	2nd Connection	Length	Note
-------------	-----------------------------	----------------	--------	------

For use with a G3 Max when connecting directly to the pump, when LED is required.

25M602	M12 female, straight	Flying leads	16.5 ft (5 m)	PNP switch with NPN LED – requires 124594
25M603	M12 female, straight	M12 male, straight	16.5 ft (5 m)	PNP switch with NPN LED
25U234	M12 female, straight	M12 male, straight	2 ft (0.6 m)	PNP switch with NPN LED

For use with a G-Mini, a PLC or an external lubrication controller, when LED is required.

25M604	M12 female, straight	Flying leads	16.5 ft (5 m)	-
24Z720	M12 female, 90°		16.5 ft (5 m)	
26A782	M12 female, 90°		33 ft (10 m)	

OTHER M12 CABLES, WITHOUT LED INDICATION

Part Number	Proximity Switch Connection	2nd Connection	Length	Note
126331	M12 female, straight	Flying lead	16.5 ft (5 m)	Requires 124594 when used with G3 Max or G-Mini
124300	Flying leads	M12 male, straight	16.5 ft (5 m)	Requires 124301 when used with solid state proximity switch
124333	M12 female, straight		16.5 ft (5 m)	
131214	M12 female, 90°		3.3 ft (1 m)	
131215			6.6 ft (2 m)	
131216			9.8 ft (3 m)	
130282			3.3 ft (1 m)	
130280	M12 female, straight		6.6 ft (2 m)	
130283			9.8 ft (3 m)	

PROXIMITY SWITCHES

FSM CYCLE INDICATING PROXIMITY SWITCHES

The Field-Sensitive Magnetic proximity switch is a dry contact magnetically actuated switch. Recent design improvements allow for reliable operation with AC and DC power. For metal stamping applications and other high-shock locations, use the Solid State proximity switches instead.

Stainless Steel Construction

Pressure ratings up to 8,000 PSI (552 bar).

Electrical Connector

Mating cables are readily available with options for LED indication (DC only) and NPN conversion.



Options for Most Graco Trabon Valves

Mating threads for valves including MSP, MXP and MGO.

TYPICAL APPLICATIONS

- Cycle Indication for Series Progressive Divider Valves

TYPICAL FLUIDS

- Oil or Grease up to NLGI #2

TECHNICAL SPECIFICATIONS

Material	Stainless Steel
Operating Voltage	110 to 240 VAC, 24 VDC
Switch State	Normally Open
Rated Life Cycle	50,000,000+
Maximum Cycles Per Minute	125
Approval or Classification	UL & CSA
Instruction Manuals	313228, 313229, 313230, 3A0884

ORDERING OPTIONS

FSM PROXIMITY SWITCHES

Part Number	Electrical Connector	Maximum Pressure PSI (bar)	Instruction Manual
-------------	----------------------	----------------------------	--------------------

MSP OR MHH

557741	3-pin BH	3,500 (241)	313228
557745	Pigtail**,†	7,500 (518)	313228
557746	5-pin BH	3,500 (241)	313228
557747	4-pin CH	3,500 (241)	313230

MX OR MXP

557752	4-pin CH	8,000 (552)	313229
558938	5-pin BH	8,000 (552)	313229
563476*	3-pin BH	3,500 (241)	313228
564399	5-pin BH	3,500 (241)	313228

MGO

563970	3-pin BH	3,500 (241)	313228
563495	4-pin CH	8,000 (552)	313229
564402	5-pin BH	8,000 (552)	313229

*For gasket-seal MX and MXO valves, use part number 563969 instead of 563476

**Includes 6 ft, 3 conductor cable

†UL and CSA approved for hazardous locations: Class I, Groups A, B, C and D – Division 1; Class II, Groups E, F and G – Division 1

BH = Brad Harrison 7/8 in

CH = Crouse-Hinds 7/8 in

FSM WIRING HARNESSES

Part Number	Proximity Switch Connection	2nd Connection	Length	Note
558021	3-pin BH, straight	Flying leads	6 ft (1.83 m)	-
558022	3-pin BH, straight		12 ft (3.66 m)	-
558968	4-pin CH, straight		12 ft (3.66 m)	NPN LED, 10 to 30 VDC only
2015624	4-pin CH, straight		12 ft (3.66 m)	-
558024	5-pin BH, straight		12 ft (3.66 m)	-

PROXIMITY SWITCH THREAD ADAPTERS

	MSP to MX/MXP	MXP to MGO	MSP to MGO
Threads, female by male	7/16-20 f x 3/4-16 m	3/4-16 f x 1 3/8-16 m	7/16-20 f x 1 3/8-16 m
Adapter (bare)	561028	560583	561140
O-ring (one required)	556572	555694	555694



AIR OIL MANIFOLD

AIR OVER OIL MANIFOLDS FOR MSP VALVES

A Graco Exclusive Design! The Air Oil solution that detects air line or oil line faults in your system. Series progressive monitoring ensures your critical bearings are lubricated properly.

Convenient Manifold Design

Mounts directly to the face of standard MSP series progressive divider valve assembly.

Check Valve Design

Prevents oil from being forced into the air system if lube lines get crushed or bearings get blocked.

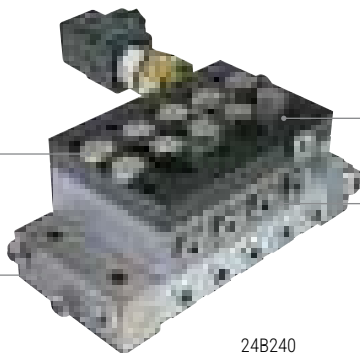

24B240
Shown installed on MSP divider valve assembly

Air Combines With The Oil

After the fluid outlet check, preventing air from backing up into your source oil system.

Complete Kits

Include manifold, air sensor and check valves for easy installation.

TYPICAL APPLICATIONS

- Steel mills, pulp and paper processing, high temperature and dirty environments

TYPICAL FLUIDS

- Oil

TECHNICAL SPECIFICATIONS

Material	Aluminum
Minimum Air Pressure	45 psi (3.1 bar)
Maximum Air Pressure	250 psi (17 bar)
Output	3, 4, 5 or 6 Section Divider Valve Assemblies
Instruction Manual	313848

ORDERING OPTIONS

AO SERIES MANIFOLDS

Part Number	Description
24B237	Air/oil manifold assembly, 3-section
24B239	Air/oil manifold assembly, 4-section
24B240	Air/oil manifold assembly, 5-section
24B241	Air/oil manifold assembly, 6-section
24J814	Air/oil manifold assembly, 3-section without air sensor
24J815	Air/oil manifold assembly, 4-section without air sensor
24J816	Air/oil manifold assembly, 5-section without air sensor
24J817	Air/oil manifold assembly, 6-section without air sensor

ACCESSORIES

Part Number	Description
562994	Air/Oil Spray Nozzle, 3/16 in OD tube inlet x 1/8 in NPT male outlet – 0.6 scfm (17 sclm) air volume per nozzle
16A171	3/16 in OD Nylon tubing, 100 ft (30 m), 2-tube, black/orange
556644	1/8 in NPT x 3/16 in OD compression fittings – for MSP valve outlet ports
105474	Air Solenoid, 24VDC/120VAC
234412	Air Filter, 1/4 in NPT inlet/outlet

ACCESSORIES

	Page
Lubricant Spray	169
Zone Valves	170
Reset Indicators	171
Automatic Relief Indicator	172
Rupture Indicator	173
Rupture to Atmosphere Indicator	174
Magnetic Visual Indicator	175
Broken Line Indicator	176
Filters	177-178
Brushes	178
Installation Accessories	
Straight and Angle Swivels	179-180
Steel Fittings	181-186
Steel Swivel Adapters	187-188
Steel JIC Fittings	189-194
Stainless Steel Fittings	195-196
Stainless Steel Swivel Adapters	197
Stainless Steel JIC Fittings	198-200
Check Valves	201-206
Pressure Sensors	207
Pressure Gauges	208
Other Fittings and Accessories	209-210
Hoses, Tubing and Fittings	211-223



LUBRICANT SPRAY

AIR-LUBE SPRA-CONTROL VALVE

The Graco Trabon Spra-Control Valve automatically allows pressurized air to enter the air-lube mixing nozzle when supplied with lubricant under pressure. The Spra-Control Valve also shuts off the pressurized air supply to the nozzle when the lubricant pressure ceases. Lubricant, oil or grease can be supplied directly from the pump, as in the case of a single isolated spray; it can also be supplied from injectors or divider valves which feed several Spra-Control Valves. In some cases where multipurpose lubricant is used, bearing taps and gear sprays may be served by the same pump and manifold system. Air-lube nozzles providing round or flat cone spray patterns are of the non-clogging external mix type.

External Mix Nozzle

Purges itself and prevents clogging.

Conserve Air

Air required only during spray interval.

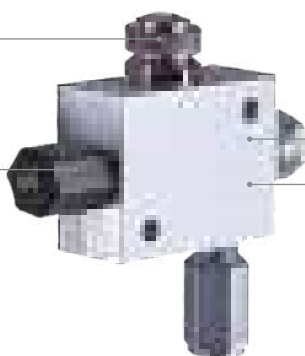

Versatile

Compatible with grease, oil and open gear lubricant (OGL).

Save Lubricant

Sprays smaller amounts at frequent intervals, providing better film with no waste.

Ball mills run at peak performance with Graco's Air-Lube Spra-Control Valve

TYPICAL APPLICATIONS

- Ball mills, rolling dryers, chains, conveyors, open gears
- Not to be used with G3, G-Mini or other low flow pumps

TYPICAL FLUIDS

- Oil – minimum of 100 SUS at 100°F
- Grease – NLGI #1 at any temperature, NLGI #2 at 32°F or above

TECHNICAL SPECIFICATIONS

Material	Aluminum
Minimum Air Pressure	20 psi (1.4 bar)
Maximum Air Pressure	150 psi (10.3 bar)
Spray Pattern	4 in or 8 in (10.2 cm or 20.3 cm)
Instruction Manual	3A3114

ORDERING OPTIONS

SPRA-CONTROL VALVES

Part Number	Description
563275	Air-lube control valve and nozzle assembly – 4 in spray diameter, round pattern
563276	Air-lube control valve and nozzle assembly – 8 in spray diameter, flat/oblong pattern

SG-2 SPRAY SYSTEM COMPONENTS

Part Number	Description
563129	Air Oil Mixing Tee
562994	Spray Nozzle for air/oil systems – use with mixing tee 563129 or any MSP air oil manifold
555727	Spare Compression Ferrule
555728	Spare Compression Nut

ZONE VALVES

Features and Benefits

- Grease solenoids designed to custom fit lubrication systems and control when sections or zones of the system will receive lubricant
- Available normally closed and normally open
- 24 VDC models meet typical application requirements
- 1/4-18 NPT female inlet and outlet ports

ORDERING OPTIONS

ZONE VALVES

Part Number	Description
24P976	Two-way valve, 24 VDC, normally open, Deutsch cable, 3,500 psi (241 bar)
24T296	Two-way valve, 24 VDC, normally closed, Deutsch cable, 3,500 psi (241 bar)



24P976



RESET INDICATORS

Features and Benefits

- Provides quick troubleshooting tool with visual indication
- No tools for reset or parts to replace after indication
- Easy information on blocked lines, high system pressure or blocked bearings

TECHNICAL SPECIFICATIONS

	Reset with Memory psi (bar)						
	250 (17)	500 (35)	750 (52)	1,000 (69)	1,500 (103)	2,000 (138)	2,500 (172)
MJ	•	•	•	•	•	•	
MSP	•	•	•	•	•	•	•
MXP	•	•	•	•	•	•	•
MX	•	•	•	•	•	•	•
MGO					•		

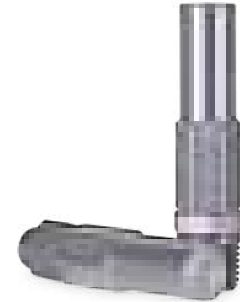

563242

Simple point troubleshooting with visual indication

ORDERING OPTIONS

DIVIDER VALVE RESET INDICATOR WITH MEMORY FOR MJ, MSP, MHH AND MXP WITH 1/8 NPT MALE THREAD

Part Number	Description
563231	250 psi (17 bar)
563232	500 psi (35 bar)
563233	750 psi (52 bar)
563234	1,000 psi (69 bar)
563235	1,500 psi (103 bar)
563236	2,000 psi (138 bar)
563237	2,500 psi (172 bar)
563238	3,500 psi (241 bar)

DIVIDER VALVE RESET INDICATOR WITH MEMORY FOR MX WITH 1/4 NPT MALE THREAD

Part Number	Description
563239	250 psi (17 bar)
563240	500 psi (35 bar)
563241	750 psi (52 bar)
563242	1,000 psi (69 bar)
563243	1,500 psi (103 bar)
563244	2,000 psi (138 bar)
563245	2,500 psi (172 bar)

DIVIDER VALVE RESET INDICATORS WITH MEMORY AND O-RING SEAL FOR MSP, MHH AND MXP WITH 1/8 NPSF MALE THREAD

Part Number	Description
563252	250 psi (17 bar)
563253	500 psi (35 bar)
563254	750 psi (52 bar)
563255	1,000 psi (69 bar)
563256	1,500 psi (103 bar)
563257	2,000 psi (138 bar)
563258	2,500 psi (172 bar)
563261	3,000 psi (207 bar)
563262	5,000 psi (345 bar)
563263	3,500 psi (241 bar)

DIVIDER VALVE RESET INDICATORS WITH MEMORY AND O-RING SEAL FOR MGO WITH 7/8 SAE MALE THREAD

Part Number	Description
564200	1,500 psi (103 bar)

AUTOMATIC RELIEF INDICATOR

Features and Benefits

These performance indicators pinpoint lube line blockages but allow the lube system to continue to supply lubrication to points that are not blocked.

- Allows machine to continue to run while non-critical bearings are lubricated
- No time or effort required for reset after blockage is cleared
- Easy information on blocked lines, high system pressure or blocked bearings

TYPICAL APPLICATIONS

- Works with MSP, MX, MXP, MJ and MHH divider valves

TECHNICAL SPECIFICATIONS

	Auto Relief psi (bar)						
	750 (52)	1,000 (69)	1,250 (86)	1,500 (103)	2,000 (138)	2,500 (172)	3,000 (207)
MJ	•	•		•	•		
MSP	•	•	•	•	•	•	•
MXP	•	•	•	•	•	•	•
MX		•		•	•	•	•



563159

Keep your machine running while lubrication gets to critical points

ORDERING OPTIONS

DIVIDER VALVE AUTOMATIC RELIEF INDICATORS FOR MX

Part Number	Description
563156	750 psi (52 bar)
563157	1,000 psi (69 bar)
563158	1,500 psi (103 bar)
563159	2,000 psi (138 bar)
563160	2,500 psi (172 bar)
563161	3,000 psi (207 bar)

DIVIDER VALVE AUTOMATIC RELIEF INDICATORS FOR MSP, MHH, MXP AND MJ

Part Number	Description
563162	150 psi (10 bar)
563375	600 psi (41 bar)
563163	750 psi (52 bar)
563164	1,000 psi (69 bar)
563166	1,500 psi (103 bar)
563167	2,000 psi (138 bar)
563168	2,500 psi (172 bar)
563169	3,000 psi (207 bar)

DIVIDER VALVE AUTOMATIC RELIEF INDICATORS WITH O-RING SEAL FOR MSP, MHH AND MXP

Part Number	Description
563170	750 psi (52 bar)
563171	1,000 psi (69 bar)
563172	1,250 psi (86 bar)
563173	1,500 psi (103 bar)
563174	2,000 psi (138 bar)
563175	2,500 psi (172 bar)
563176	3,000 psi (207 bar)



RUPTURE INDICATOR

Features and Benefits

Used on MH divider valve applications where lube system pressures exceed 2,500 psi.

- High pressure from blockage causes a disk to rupture
- Lubricant forces an indicator pin to protrude, indicating the blockage
- High pressure backs up through the system and trips a switch to shut the system off
- When fault is corrected, disk must be replaced and pin reset

TYPICAL APPLICATIONS

- Works with MHH divider valves

ORDERING OPTIONS

DIVIDER VALVE RUPTURE INDICATORS WITH MEMORY

Part Number	Description
563220	3,700 psi (255 bar)
563228	2,800 psi (193 bar)
564355	4,600 psi (317 bar)
563223	5,500 psi (379 bar)
563225	6,400 psi (441 bar)
563229	2,800 psi (193 bar) with o-ring seal
563221	3,700 psi (255 bar) with o-ring seal
563222	4,600 psi (317 bar) with o-ring seal
563224	5,500 psi (379 bar) with o-ring seal
563226	6,400 psi (441 bar) with o-ring seal

REPLACEMENT RUPTURE DISKS

Part Number	Description
557422	2,800 psi (193 bar)
557423	3,700 psi (255 bar)
557424	4,600 psi (317 bar)
557425	5,500 psi (379 bar)
557427	6,400 psi (441 bar)
557428	7,300 psi (503 bar)
557429	8,200 psi (565 bar)

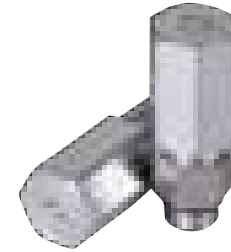

563229

Know quickly when critical bearings aren't getting lubricated

RUPTURE TO ATMOSPHERE INDICATOR

Features and Benefits

- Used in conjunction with system pressure switch – can warn of a fault while allowing lube system to continue to deliver to critical bearings
- Requires replacement of the rupture disk to restart the lube system
- Easy information on blocked lines, high system pressure or blocked bearings

TECHNICAL SPECIFICATIONS

	Rupture to Atmosphere psi (bar)					
	1,450 (100)	1,750 (121)	2,050 (141)	2,350 (162)	2,950 (203)	3,250 (224)
MJ		•		•	•	•
MSP		•		•	•	•
MX	•	•	•	•	•	

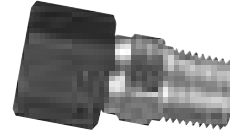

563191

Blockages are easy to detect with the simple Rupture to Atmosphere indicator

ORDERING OPTIONS

RUPTURE-TO-ATMOSPHERE INDICATORS FOR MJ, MSP, MHH AND MXP

Part Number	Description
564059	1,750 psi (121 bar)
563191	2,350 psi (162 bar)
563192	2,950 psi (203 bar)
563193	3,250 psi (224 bar)
563194	5,000 psi (345 bar)
563218	6,400 psi (441 bar)
563219	7,300 psi (503 bar)
563217	5,500 psi (379 bar)

RUPTURE-TO-ATMOSPHERE INDICATORS FOR MX

Part Number	Description
563179	1,450 psi (100 bar)
563182	1,750 psi (121 bar)
563183	2,050 psi (141 bar)
563184	2,350 psi (162 bar)
563185	2,950 psi (203 bar)
563186	1,450 psi (100 bar), with spud assembly
563187	1,750 psi (121 bar), with spud assembly
563188	2,350 psi (162 bar), with spud assembly

REPLACEMENT RUPTURE PACKS OF 6

(11/16 in / 17.5 mm diameter disks)

Part Number	Description
563962	1,450 psi (100 bar) – yellow
563963	1,750 psi (121 bar) – red
563964	2,050 psi (141 bar) – orange
563965	2,350 psi (162 bar) – aluminum
563966	2,950 psi (203 bar) – blue

REPLACEMENT RUPTURE PACKS OF 25

(3/8 in / 9.5 mm diameter disks)

Part Number	Description
563954	1,450 psi (100 bar) – yellow
563955	1,750 psi (121 bar) – red
563956	2,050 psi (141 bar) – orange
563957	2,350 psi (162 bar) – aluminum
563958	2,650 psi (183 bar) – pink
563959	2,950 psi (203 bar) – blue
563960	3,250 psi (224 bar) – purple
563961	5,000 psi (345 bar) – brown



MAGNETIC VISUAL INDICATOR

Features and Benefits

Six steel balls in a clear sleeve follow a magnet which moves with the cycling piston, providing a clear visual indication of lube cycles.

ORDERING OPTIONS

DIVIDER VALVE CYCLE INDICATORS AND SWITCHES

Part Number	Description
563251	MS/MHH visual cycle indicator assembly – O-ring seal
563260	MX/MXP visual cycle indicator assembly



563251

CYCLE SWITCH

- Monitors piston movement to ensure completed lubrication cycle – must have cycle indicator pin
- Provides positive feedback based on actual metering piston movement
- Mounts to MJ, MSP, MXP or MX divider with cycle pin option with simple install
- Able to be set for normally open or normally closed operation

TECHNICAL SPECIFICATIONS

Voltage	Amp Rating
125/250/480 VAC	15A
125 VDC	1/2A
250 VDC	1/4A
24 VDC	6A*

*Non-inductive



563272

Integrates to controllers, starters or PLCs

ORDERING OPTIONS

CYCLE SWITCHES

Part Number	Description
563270	MD-2, cycle switch, bracket assembly
563271	MD-3, cycle switch, bracket assembly
564356	MD-4, cycle switch, bracket assembly
563269	MGO cycle switch (SPDT), bracket assembly
557781	Replacement cycle switch for 563269, 563270, 563271, 564356, 563272
564357	MJ/MS/MHH/MXP cycle switch (DPDT) bracket assembly
563272	MJ/MS/MHH/MXP cycle switch (SPDT) bracket assembly
563273	MJ/MS/MHH/MXP cycle switch (SPDT) bracket assembly – moisture resistant
557546	Replacement bracket – 563272, 563273, 564357
260067	1/2 in NPT cord grip for use with switch 557781

BROKEN LINE INDICATORS

Features and Benefits

- Monitors lube line integrity to ensure lubricant is delivered to critical bearings
- Provides a visual or electronic indication
- Works with terminating oil or grease systems as well as recirculating systems

TECHNICAL SPECIFICATIONS

	BLI500	BLI1000	BLI1500
Simulator Pressure	60 psi (4.1 bar)	100 psi (6.9 bar)	150 psi (10.3 bar)
Minimum Pump Pressure	1,000 psi (69.0 bar)	1,500 psi (103.4 bar)	2,500 psi (172.4 bar)
Application	Recirculating Oil	Recirculating Oil or Terminating Oil	Grease



The only device that provides visual indication that bearing lines are intact

ORDERING OPTIONS

BROKEN LINE INDICATORS

System Type	BLI Rating	Simulator Rating	ΔP	Pressure Switch Setting (psi)	Pump Relief Valve (psi)	Blowout Disk (psi)	Minimum Pump Capacity (psi)	BLI Kit Part Number	BLI Part Number	Simulator Part Number
Re-Circulating Oil	500	60	440	400	700	N/A	1,000	563078	563068	563075
Re-Circulating Oil	1,000	100	900	850	1,400	N/A	1,500	563079	563069	563076
Terminating Oil	1,000	100	900	850	N/A	1,450	2,000	563079	563069	563076
Terminating Grease	1,500	150	1,350	1,300	N/A	2,350	2,500	563080	563070	563077



FILTERS

ORDERING OPTIONS

All filter ports are female both end (fbc) unless otherwise stated. For more details, search www.graco.com for brochure L15200.

MSP INLET OIL FILTERS

Typically used as a secondary filter at the inlet of MSP divider valve assemblies.

Part Number	Type	Max Pressure PSI (bar)	Ports	Micron Rating
563074	MSP zero-leak inlet "last chance" filter/restrictor	3,500 (241)	1/4-18 NPSF f x 1/4-18 NPTF m	90
563073	MSP zero-leak and shunt "last chance" filter		9/16-18 SAE-ORB female x male	
564342	MSP standard and zero-leak inlet filter		1/4-19 BSPP female x male	
563480	ZMSP modular filter block	3,000 (207)	Mounts on base 563479	25

REPLACEMENT ELEMENTS FOR LEGACY SINGLE AND DUAL CARTRIDGE FILTERS

Use to replace string filters and pleated elements in legacy Trabon/Manzel canister filters.

Part Number	Dimensions	Micron Rating	Where used – legacy filter part number
557803	2-5/8 in (67 mm) OD x 3-5/8 in (92 mm) L	10	183-000-001, 183-000-041, 183-000-141
557804		25	183-000-011, 183-000-051, 183-000-151
557805		50	50 micron alternate for 3-5/8 in elements (above)
557806	2-5/8 in (67 mm) OD x 9-5/8 in (244 mm) L	10	183-000-071, 183-000-111, 183-000-201
557807		25	183-000-081, 183-000-121, 183-000-211
557808		50	50 micron alternate for 9-5/8 in elements (above)
557811		1	1 micron alternate for 9-5/8 in elements (above)

SPIN-ON OIL FILTERS

Low pressure, high flow oil filters for applications up to 20 gpm (76 lpm). Typical applications include return lines in recirculating systems and fill lines.

Part Number	Type	Max Pressure PSI (bar)	Ports	Replacement Element	Micron Rating
563095	Assembly with external 150 PSI (10.3 bar) relief	200 (13.8)	3/4-14 NPT	563093	10
564343	Assembly 563095 with fill stud and mounting bracket				
563096	Assembly with external 150 PSI (10.3 bar) relief				
563099	Assembly with external 150 PSI (10.3 bar) relief	150 (10.3)	3/4-14 BSPP (ISO 1179-1)	563097	25
563100	Assembly with external 150 PSI (10.3 bar) relief		M27x2 (ISO 6149)		

SPARE PARTS FOR SPIN-ON OIL FILTERS

Part Number	Description
563162	150 PSI external relief valve, 1/8 NPT
558927	Filter mounting bracket

FILTERS AND BRUSHES

ORDERING OPTIONS

IN-LINE OIL FILTER – HIGH-PRESSURE

Use with Trabon and G-series pumps in medium duty applications. Miniature Meter-Flo and Modu-Flo oil tanks include a bracket designed to receive these filters. Always mount plug end down, so the contaminants fall out with the element when it's changed. Use bleed ports on top to purge air.

Part Number	Max Pressure PSI (bar)	Ports	Replacement Element	Micron Rating
563511	7,500 (517)	1/4-18 NPTF	563509	10
563512			563510	25
563516		1/4-19 BSPP (ISO 1179)	563509	10
563515			563510	25

IN-LINE GREASE/HEAVY OIL STRAINER – HIGH-PRESSURE

Use with Trabon and G-series pumps in medium duty applications. Install on reservoir fill line or near pump outlet to protect system from contaminants. Always mount plug end down, so the contaminants fall out with the element when it's changed. Use bleed ports on top to purge air.

Part Number	Type	Max Pressure PSI (bar)	Ports	Replacement Element	Micron Rating (Mesh Rating)
563508	Heavy oil strainer	7,500 (517)	1/4-18 NPTF	557701	44 (325)
563507	Grease strainer		1/4-18 NPTF	557700	149 (100)
564406			1/4-19 BSPP (ISO 1179)		

FILL POINT STRAINERS WITH REMOVABLE ELEMENT

Installs in fill port on reservoirs with 1/4 in NPT thread.

Part Number	Type	Max Pressure PSI (bar)	Ports	Replacement Element	Micron Rating (Mesh Rating)
563103	Oil	3,000 (207)	1/4-18 NPSF f x 1/4-18 NPTF m	557154	44 (325)
563102	Grease			557153	149 (100)

BARREL PUMP FILL LINE FILTER

Small inline filter for use as a fill filter for barrel pump modules including Fire-Ball and Dyna-Star families.

Part Number	Type	Max Pressure PSI (bar)	Ports	Replacement Element	Micron Rating
77X523	Inline fill line filter	5,000 (344)	3/8-18 NPTF female inlet x male outlet	77X541	400

“RED ALERT” GREASE FILTER

Ideal for use as a fill line filter for barrel pump modules including Fire-Ball and Dyna-Star families. The indicator provides gradual warning of a dirty element.

Part Number	Type	Max Pressure PSI (bar)	Ports	Replacement Element	Micron Rating
17L366	36 in ² steel mesh filter, 2 gpm (7.57 lpm) flow capacity	3,000 (207)	3/4-14 NPT	129031	380

OIL BRUSHES

Part Number	Material	Dimensions	Maximum Temperature	Thread
124089	Horsehair	3/4 in (20 mm) diameter	176°F (80°C)	1/4 in-19 BSPP female
124090		1.2 in (30 mm) x 1.6 in (40 mm)		



INSTALLATION ACCESSORIES – STRAIGHT AND ANGLE SWIVELS



GO FOR A SPIN

The Trabon Straight and Angle Swivels are available in standard ball bearing or compact types. Primarily designed for medium to high pressure service in centralized oil and grease systems, these swivels provide a simple and inexpensive means of making line connections between either stationary, or oscillating surfaces.

Ball Bearing Swivels

Turn freely at high pressure without binding and should always be used if space permits. Stems and nuts are hardened to minimize wear.

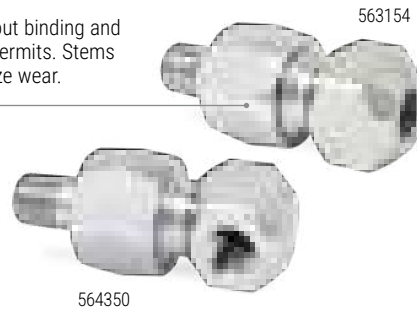

TYPICAL FLUIDS

• Oil or Grease up to NLGI #2

TECHNICAL SPECIFICATIONS

Material	Carbon Steel
Packing	Buna
Maximum RPM	1800

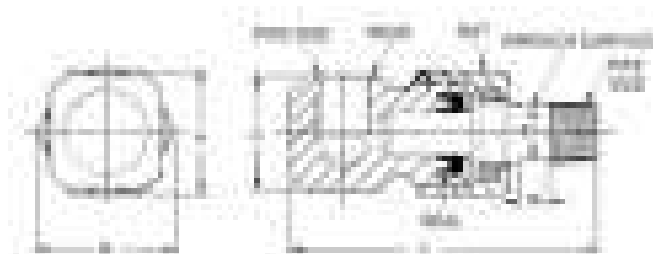

ORDERING OPTIONS

STRAIGHT AND ANGLE BALL BEARING SWIVELS

Pipe Thread	Part Number		Maximum Pressure PSI (Bar)	Dimension in Inches (mm)						
	90° Angle	Straight		Ball Diameter	Hex Nut (A)	Hex Nut (B)	Square Head (C)	Length (L)	Flat (T)	Flat (W)
1/8 in-27	563212	563213	1,500 (103.5)	0.09 (2.3) qty 14	0.875 (22.2)	1.01 (25.7)	0.75 (19.1)	2.28 (57.9)	0.31 (7.9)	0.25 (6.4)
1/4 in-18	563214	563215	1,500 (103.5)	0.09 (2.3) qty 18	1.00 (25.4)	1.15 (29.2)	0.875 (22.2)	2.75 (69.9)	0.44 (11.1)	0.31 (7.9)
3/8 in-18	563153	564349	3,000 (207)	Ball Bearing	1.375 (34.9)	1.62 (41.1)	1.125 (28.6)	3.93 (99.8)	0.56 (14.3)	0.37 (9.5)
1/2 in-14	564350	563154	3,000 (207)	Ball Bearing	1.75 (44.5)	2.03 (51.6)	1.50 (38.1)	4.50 (114.3)	0.75 (19.0)	0.44 (11.1)
3/4 in-14	–	564351	3,000 (207)	Ball Bearing	1.875 (47.6)	2.18 (55.4)	1.75 (44.5)	5.37 (136.4)	0.94 (23.8)	0.50 (12.7)

INSTALLATION ACCESSORIES – STRAIGHT AND ANGLE SWIVELS

Compact Swivels

Manufactured without ball bearings and are not intended for rotary, or oscillating movement. Should be used only for positioning a connection, or where occasional movement is required.



TYPICAL FLUIDS

- Oil or Grease up to NLGI #2

TECHNICAL SPECIFICATIONS

Material	Plated or 303 Stainless
Packing	Buna

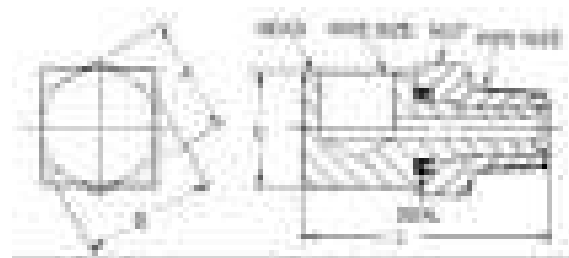

ORDERING OPTIONS

STRAIGHT AND ANGLE COMPACT SWIVELS

Pipe Thread	Part Number		Maximum Pressure PSI (Bar)	Material of Construction	Dimension in Inches (mm)			
	90° Angle	Straight			Hex Nut (A)	Hex Nut (B)	Square Head (C)	Length (L)
1/8 in-27	563148	563150	500 (34.5)	Carbon Steel	0.563 (14.3)	0.65 (16.5)	0.563 (14.3)	1.12 (28.4)
1/8 in-27	563149	–	500 (34.5)	303 Stainless	0.563 (14.3)	0.65 (16.5)	0.563 (14.3)	1.12 (28.4)
1/4 in-18	563146	563147	500 (34.5)	Carbon Steel	0.75 (19.1)	1.06 (26.9)	0.75 (19.1)	1.62 (41.1)

INSTALLATION ACCESSORIES – STEEL FITTINGS



ORDERING OPTIONS

PIPE THREAD STEEL FITTINGS

45° STREET ELBOWS

Male Thread	Female Thread	Maximum Pressure PSI (Bar)	Part Number
1/4 in-18 NPT	1/4 in-18 NPT	3,500 (241)	119789
1/4 in-18 NPT	1/4 in-18 NPT	5,000 (345)	121283
3/8 in-18 NPT	3/8 in-18 NPT	4,000 (276)	116756
1/2 in-14 NPT	1/2 in-14 NPT	4,000 (276)	116755
3/4 in-14 NPT	3/4 in-14 NPT	5,000 (345)	113445
1 in-11.5 NPT	1 in-11.5 NPT	4,200 (290)	123888

45° STREET ELBOWS – ZERO RADIUS

Male Thread	Female Thread	Maximum Pressure PSI (Bar)	Part Number
1/4 in-28 SAE tapered	1/8 in-27 NPTF	-	557954
1/8 in-27 NPT	1/8 in-27 NPT	-	557395
1/4 in-18 PTF SAE Short	1/4 in-18 PTF SAE extra short	-	560532

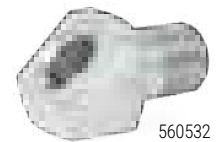

90° STREET ELBOWS

Male Thread	Female Thread	Maximum Pressure PSI (Bar)	Part Number
1/8 in-27 NPT	1/8 in-27 NPT	5,000 (345)	112307
1/4 in-18 NPT	1/4 in-18 NPT	4,000 (276)	118137
3/8 in-18 NPT	3/8 in-18 NPT	4,500 (310)	111856
3/4 in-14 NPT	3/4 in-14 NPT	3,000 (207)	122327
1 in-11.5 NPT	1 in-11.5 NPT	4,200 (290)	123889
1.25 in-11.5 NPT	1.25 in-11.5 NPT	6,000 (414)	C38324

90° STREET ELBOWS – ZERO RADIUS

Male Thread	Female Thread	Maximum Pressure PSI (Bar)	Part Number
1/4 in-28 SAE tapered	1/8 in-27 NPTF	-	15K784
1/8 in-27 PTF SAE short*	1/8 in-27 PTF SAE short*	-	15K783
1/8 in-27 NPT	1/8 in-27 NPT	3,600 (248)	100839
1/8 in-27 NPTF	1/4 in-18 NPSF	-	560530
1/8 in-28 BSPT	1/8 in-27 PTF SAE short*	-	17K061
1/4 in-18 NPTF	1/4 in-18 NPSF	-	15M045
1/4 in-18 NPTF	1/8 in-27 PTF SAE short*	-	560533
1/4 in-18 NPT	1/4 in-18 NPT	7,500 (517)	100840
3/8 in-18 NPT	1/4 in-18 NPT	7,250 (500)	164259
3/8 in-18 NPT	3/8 in-18 NPT	7,250 (500)	155699
1/2 in-14 NPT	3/8 in-18 NPT	7,250 (500)	166999
1/2 in-14 NPT	1/2 in-14 NPT	7,400 (510)	158683
1/2 in-14 NPT	1/2 in-14 NPT	3,000 (207)	115764
3/4 in-14 NPT	3/4 in-14 NPT	7,250 (500)	166590

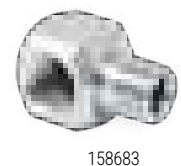

*1/8 in-27 PTF SAE short thread is common on grease nipples (Zerks).

INSTALLATION ACCESSORIES – STEEL FITTINGS

ORDERING OPTIONS

PIPE THREAD STEEL FITTINGS

90° STREET ELBOWS EXTENSION FITTINGS – ZERO RADIUS

Male Thread	Female Thread	Total Length	Part Number
1/8 in-27 NPT	1/8 in-27 NPT	1.4 in (35.6 mm)	191892
1/8 in-27 NPT	1/8 in-27 NPT	2.0 in (50.8 mm)	160701

HEX NIPPLES – STANDARD AND REDUCING

Male Thread (A)	Male Thread (B)	Maximum Pressure PSI (Bar)	Part Number
1/8 in-27 NPT	1/8 in-27 NPT	6,000 (414)	C20477
1/4 in-18 NPT	1/8 in-27 NPT	4,000 (276)	16Y235
1/4 in-18 NPT	1/8 in-27 NPT	6,000 (414)	16D939
1/4 in-18 NPT	1/8 in-27 NPT	7,500 (517)	151519
1/4 in-18 NPTF	1/8 in-27 NPTF	–	556408
1/4 in-18 NPT	1/4 in-18 NPT	7,500 (517)	156971
1/4 in-18 NPTF	1/4 in-18 NPTF	–	555453
3/8 in-18 NPT	1/8 in-27 NPT	–	156296
3/8 in-18 NPT	1/4 in-18 NPT	4,000 (276)	123379
3/8 in-18 NPT	1/4 in-18 NPT	6,000 (414)	157350
3/8 in-18 NPT	1/4 in-18 NPT	10,000 (689)	165198
3/8 in-18 NPT	3/8 in-18 NPT	7,250 (500)	156849
1/2 in-14 NPT	1/4 in-18 NPT	7,400 (510)	162449
1/2 in-14 NPT	3/8 in-18 NPT	7,400 (510)	159239
1/2 in-14 NPT	3/8 in-18 NPT	7,400 (510)	16F255
1/2 in-14 NPT	1/2 in-14 NPT	7,400 (510)	158491
1/2 in-14 NPT	1/2 in-14 NPT	6,000 (414)	C20485
3/4 in-14 NPT	3/8 in-18 NPT	4,000 (276)	194048
3/4 in-14 NPT	1/2 in-14 NPT	6,000 (414)	157191
3/4 in-14 NPTF	1/2 in-14 NPTF	6,000 (414)	C20461
3/4 in-14 NPTF	3/4 in-14 NPTF	5,500 (379)	C20487
3/4 in-14 NPT	3/4 in-14 NPT	7,250 (500)	175013
3/4 in-14 NPT	3/4 in-14 NPT	7,250 (500)	160032
1 in-11.5 NPT	3/4 in-14 NPT	3,000 (207)	158555
1 in-11.5 NPT	1 in-11.5 NPT	3,000 (207)	C20489
1 in-11.5 NPT	1 in-11.5 NPT	4,500 (310)	17G388
1 in-11.5 NPT	1 in-11.5 NPT	6,000 (414)	131526
1.25 in-11.5 NPTF	3/4 in-14 NPT	3,000 (207)	124508
1.25 in-11.5 NPTF	1 in-11.5 NPTF	5,000 (345)	C20465
1.25 in-11.5 NPTF	1.25 in-11.5 NPTF	3,000 (207)	C20490
1.5 in-11.5 NPT	1 in-11.5 NPT	3,000 (207)	17G711
9/16 in-18 SAE-ORB (Buna-N)	9/16 in-18 SAE-ORB (Buna-N)	6,000 (414)	131169



555453



156296



156849



ORDERING OPTIONS

PIPE THREAD STEEL FITTINGS

HEX COUPLINGS – STANDARD AND REDUCING

Female Thread (A)	Female Threads (B)	Maximum Pressure PSI (Bar)	Part Number
1/8 in-27 NPSF	1/8 in-27 NPSF	-	560528
1/8 in-27 NPT	1/8 in-27 NPT	-	100451
1/4 in-18 NPT	1/4 in-18 NPT	7,250 (500)	113093
3/8 in-18 NPT	1/4 in-18 NPT	6,000 (414)	132139
3/8 in-18 NPT	3/8 in-18 NPT	7,250 (500)	162024
1/2 in-14 NPT	1/2 in-14 NPT	7,250 (500)	158581
3/4 in-14 NPT	3/4 in-14 NPT	4,000 (276)	16P292
1 in-11.5 NPT	1 in-11.5 NPT	3,000 (207)	100474
1.5 in-11.5 NPT	1 in-11.5 NPT	3,000 (207)	116650

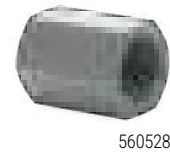

REDUCING BUSHINGS

Male Thread	Female Thread	Maximum Pressure PSI (Bar)	Part Number
1/4 in-18 NPTF	1/8 in-27 NPTF	-	556402
1/4 in-18 NPT	1/8 in-27 NPT	-	100030
3/8 in-18 NPT	1/4 in-18 NPT	7,250 (500)	159841
3/8 in-18 NPT	1/4 in-18 NPT	6,000 (414)	118758
3/8 in-18 NPT	1/4 in-18 NPT	6,000 (414)	129535
3/8 in-18 NPTF	1/8 in-27 NPTF	-	556403
3/8 in-18 NPTF	1/4 in-18 NPTF	-	556404
1/2 in-14 NPTF	1/8 in-27 NPTF	-	556405
1/2 in-14 NPTF	3/8 in-18 NPTF	-	556406
1/2 in-14 NPT	1/4 in-18 NPT	7,250 (500)	100206
1/2 in-14 NPT	3/8 in-18 NPT	3,000 (207)	18B302
1/2 in-14 NPT	3/8 in-18 NPT	4,000 (276)	158212
1/2 in-14 NPT	3/8 in-18 NPT	6,000 (414)	100081
3/4 in-14 NPT	1/4 in-18 NPT	5,000 (345)	100615
3/4 in-14 NPTF	1/4 in-18 NPTF	-	558794
3/4 in-14 NPT	1/4 in-18 NPT	7,250 (500)	C19681
3/4 in-14 NPT	3/8 in-18 NPT	5,000 (345)	100505
3/4 in-14 NPT	1/2 in-14 NPT	5,000 (345)	100896
3/4 in-14 NPT	1/2 in-14 NPT	5,000 (345)	C19685
1 in-11.5 NPT	1/2 in-14 NPT	4,500 (310)	100380
1 in-11.5 NPT	3/4 in-14 NPT	6,000 (414)	158586
1.25 in-11.5 NPT	1/2 in-14 NPT	6,000 (414)	C19660

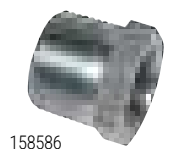

INSTALLATION ACCESSORIES – STEEL FITTINGS

ORDERING OPTIONS

PIPE THREAD STEEL FITTINGS

EXPANDING BUSHINGS

Male Thread	Female Thread	Maximum Pressure PSI (Bar)	Part Number
1/4 in-28 SAE tapered	1/8 in-27 NPT	–	557955
1/8 in-27 NPT	1/4 in-18 NPT	–	556416
1/8 in-27 NPT	1/4 in-18 NPT	–	159840
1/8 in-27 NPT	3/8 in-18 NPT	–	156580
1/4 in-18 NPT	3/8 in-18 NPT	8,000 (552)	150287
1/4 in-18 NPT	1/2 in-14 NPT	–	159842
3/8 in-18 NPT	1/2 in-14 NPT	4,000 (276)	156022
1/2 in-14 NPT	3/4 in-14 NPT	7,250 (500)	16T315



EXTENSION FITTINGS – STRAIGHT

Male Thread	Female Thread	Total Length	Part Number
1/8 in-27 PTF SAE short	1/8 in-27 NPTF	0.75 in (19.1 mm)	557392
1/8 in-27 NPT	1/8 in-27 NPT	1.0 in (25.4 mm)	150171
1/8 in-27 NPTF	1/8 in-27 NPSF	1.25 in (31.75 mm)	557393
1/8 in-27 NPT	1/8 in-27 NPSF	2.5 in (63.5 mm)	563178
3/8 in-18 NPT	1/4 in-18 NPT	2.75 in (69.9 mm)	162718
3/8 in-18 NPT	3/8 in-18 NPT	1.5 in (38.1 mm)	150286



ADAPTER FITTINGS

Male Thread	Female Thread	Shape	Part Number
1/8 in-28 BSPT	1/8 in-27 PTF SAE short	90° Elbow – Zero Radius	17K061
1/8 in-28 BSPT	1/8 in-27 NPTF	Straight – 1.08 in (22.4 mm) L	17G422
1/8 in-28 BSPT	1/8 in-27 NPSF	Straight – 1.25 in (31.8 mm) L	17K062
M6 x0.75	1/8 in-27 NPTF	Straight – 1.04 in (26.5 mm) L	131430
M10 x1	1/8 in-27 NPTF	Straight – 1.25 in (31.8 mm) L	131466
9/16 in-18 SAE-ORB (Buna-N)	1/4 in-18 NPT	Straight Adapter	129764
9/16 in-18 SAE-ORB (Buna-N)	3/8 in-18 NPT	90° Elbow Adapter	127104



TEE FITTINGS – FEMALE

Thread	Maximum Pressure PSI (Bar)	Part Number
1/8 in-27 NPT	3,000 (207)	C19466
1/4 in-18 NPT	5,000 (345)	104984
3/8 in-18 NPT	4,500 (310)	100483
3/4 in-14 NPT	6,000 (414)	132019
1-1/4 in NPT	6,000 (414)	C19491

TEE FITTINGS – MALE

Thread	Maximum Pressure PSI (Bar)	Part Number
1/4 in-18 NPT	3,900 (269)	113548
3/8 in-18 NPT	4,000 (276)	113786



ORDERING OPTIONS

PIPE THREAD STEEL FITTINGS

TEE FITTINGS – MALE BRANCH

Thread	Maximum Pressure PSI (Bar)	Part Number
1/8 in-27 NPT zero radius	6,000 (414)	164815
1/8 in-27 NPTF	5,000 (345)	558795
1/4 in-18 NPTF	5,000 (345)	556407
3/8 in-18 NPTF	4,500 (310)	128567
1/2 in-14 NPT	3,500 (241)	125644
3/4 in-14 NPT	3,000 (207)	125548



TEE FITTINGS – MALE RUN (STREET TEES)

Thread	Maximum Pressure PSI (Bar)	Part Number
1/8 in-27 NPTF	5,000 (345)	556419
1/4 in-18 NPTF	6,000 (414)	556420
3/8 in-18 NPTF	4,500 (310)	128568
1/2 in-14 NPTF	3,000 (207)	107128
3/4 in-14 NPT	3,000 (207)	16F259



CROSS FITTINGS – FFFF PORTING

Thread	Maximum Pressure PSI (Bar)	Part Number
1/4 in-18 NPTF	5,000 (345)	17T246
3/8 in-18 NPTF	4,000 (276)	512420
3/4 in-14 NPT	3,000 (207)	U70015
1 in-11.5 NPT	6,000 (414)	121163

CROSS FITTINGS – FFFM PORTING

Thread	Maximum Pressure PSI (Bar)	Part Number
1/4 in-18 NPTF	5,000 (345)	133643
3/8 in-18 NPTF	4,500 (310)	133644

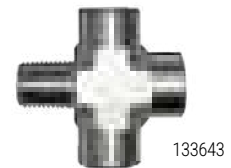

ANCHOR FITTINGS

Thread	Shape	Part Number
1/8 in-27 NPSF	Cross	560543
1/4 in-18 NPSF	Cross	560542
1/8 in-27 NPSF	Straight	560540
1/4 in-18 NPSF	Straight	560541
1/2 in-14 NPSF	Straight	558910
1/4 in-18 NPSF	Straight – Double	561430



INSTALLATION ACCESSORIES – STEEL FITTINGS

ORDERING OPTIONS

PIPE THREAD STEEL FITTINGS

PLUGS

Thread	Head Shape	Maximum Pressure PSI (Bar)	Part Number
1/8 in-27 NPT	Hex	–	556410
1/8 in-27 NPTF	None (Socket)	–	557349
1/8 in-28 BSPP (Buna-N)	Socket	5,801 (400)	558799
1/4 in-18 NPT	Hex	–	555808
1/4 in-18 NPT	Square	–	111697
1/4 in-18 NPTF	None (Socket)	–	557391
1/4 in-18 NPTF	Square	6,000 (414)	100509
1/4 in-18 PTF SAE short	None (Socket)	7,250 (500)	100721
1/4 in-19 BSPP (Buna-N)	Socket	5,801 (400)	556427
3/8 in-18 NPT	Hex	–	556411
3/8 in-18 NPT	None (Socket)	5,000 (345)	127099
3/8 in-18 NPTF	Square	–	100040
3/8 in-18 NPTF	None (Socket)	7,250 (500)	101754
7/16-20 SAE-ORB (Fluoroelastomer)	Socket	7,500 (517)	567251
1/2 in-14 NPTF	Square	6,000 (414)	100737
1/2 in-14 NPTF	Hex	3,000 (207)	125222
1/2 in-14 PTF SAE short	None (Socket)	7,250 (500)	100361
3/4 in-14 NPT	Square	3,000 (207)	104663
9/16-18 SAE-ORB (Buna-N)	Socket	6,000 (414)	129752
9/16-18 SAE-ORB (Fluoroelastomer)	Socket	5,000 (345)	15H304
3/4-16 SAE-ORB (Fluoroelastomer)	Socket	5,000 (345)	295607
7/8-14 SAE-ORB (Fluoroelastomer)	Socket	–	556424



557349



100737

INSTALLATION ACCESSORIES – STEEL SWIVEL ADAPTERS



ORDERING OPTIONS

SWIVEL ADAPTERS

- Female NPSM swivels allow for easy clocking of the fitting.
- Not a “live” swivel; position is stationary after tightened.

STRAIGHT SWIVEL ADAPTERS, MBF

Rigid Thread (Male)	Swivel Thread (Female)	Maximum Pressure PSI (Bar)	Part Number
1/8 in	1/4 in	10,000 (689)	208434
1/4 in	1/8 in	5,000 (345)	125783
1/4 in	1/4 in	10,000 (689)	156823
1/4 in	3/8 in	7,500 (517)	157705
3/8 in	3/8 in	7,500 (517)	155665
3/8 in	1/2 in	7,500 (517)	162505
1/2 in	3/8 in	7,500 (517)	158256
1/2 in	1/2 in	7,250 (500)	156684
1/2 in	3/4 in	4,000 (276)	113344
3/4 in	3/4 in	6,000 (414)	157785
1 in	3/4 in	4,500 (310)	202965
1 in	1 in	2,000 (138)	160022
1 in	1 in	3,000 (207)	116648
1 in	1 1/4 in	3,000 (207)	116745



156823

STRAIGHT SWIVEL ADAPTERS, FBE

Rigid Thread (Female)	Swivel Thread (Female)	Maximum Pressure PSI (Bar)	Part Number
1/4 in	1/4 in	10,000 (689)	155570
3/8 in	1/4 in	7,500 (517)	159153
3/8 in	3/8 in	7,400 (510)	156173
1/2 in	1/4 in	6,000 (414)	155653
1/2 in	3/8 in	3,500 (241)	161077
1/2 in	1/2 in	7,250 (500)	155865
3/4 in	3/4 in	5,000 (345)	156172
1 in	1 in	2,000 (138)	158383



155570

90° ELBOW SWIVEL ADAPTERS, MBF

Rigid Thread (Male)	Swivel Thread (Female)	Maximum Pressure PSI (Bar)	Part Number
1/4 in	1/4 in	5,000 (345)	155541
3/8 in	1/4 in	7,000 (483)	155495
3/8 in	3/8 in	5,000 (345)	155494
3/8 in	1/2 in	3,500 (241)	217430
1/2 in	3/8 in	4,000 (276)	161037
1/2 in	1/2 in	5,000 (345)	155470
3/4 in	3/4 in	2,250 (155)	160327



155494

INSTALLATION ACCESSORIES – STEEL SWIVEL ADAPTERS

ORDERING OPTIONS

SWIVEL ADAPTERS

- Female NPSM swivels allow for easy clocking of the fitting.
- Not a "live" swivel; position is stationary after tightened.

90° ELBOW SWIVEL ADAPTERS, FBE

Rigid Thread (Female)	Swivel Thread (Female)	Maximum Pressure PSI (Bar)	Part Number
1/8 in	1/8 in	6,000 (414)	C19005
1/4 in	1/4 in	5,000 (345)	157676
3/8 in	3/8 in	4,000 (276)	155677
3/8 in	1/2 in	3,500 (241)	159801
1/2 in	1/2 in	3,500 (241)	157416
3/4 in	3/4 in	2,250 (155)	156589



155677

45° ELBOW SWIVEL ADAPTERS, MBF

Rigid Thread (Male)	Swivel Thread (Female)	Maximum Pressure PSI (Bar)	Part Number
1/4 in	1/4 in	5,000 (345)	114030
3/8 in	3/8 in	4,000 (276)	161889
1/2 in	1/2 in	3,500 (241)	222297
3/4 in	3/4 in	2,200 (152)	105281



161889

FEMALE TEE: RIGID BRANCH, SWIVEL RUNS

Rigid Branch (Female)	Swivel Runs (Female)	Maximum Pressure PSI (Bar)	Part Number
1/4 in	1/4 in	5,000 (345)	119783
1/4 in	3/8 in	4,000 (276)	127518

INSTALLATION ACCESSORIES – STEEL JIC FITTINGS



ORDERING OPTIONS

JIC FITTINGS – CARBON STEEL

JIC MALE STRAIGHT NIPPLES

Male Thread (A)	Male Thread (B)	Maximum Pressure PSI (Bar)	Part Number
JIC-4	JIC-4	7,500 (517)	123251
JIC-6	JIC-6	6,000 (414)	125778
JIC-6	JIC-8	4,500 (310)	123684
JIC-6	JIC-10	3,500 (241)	123683
JIC-8	JIC-8	5,000 (345)	124451
JIC-10	JIC-10	5,000 (345)	130993
JIC-10	JIC-12	5,000 (345)	130996

JIC MALE STRAIGHT ADAPTERS

Male Thread (A)	Male Thread (B)	Maximum Pressure PSI (Bar)	Part Number
JIC-3	1/8 in-27 NPT	6,000 (414)	124403
JIC-4	1/8 in-27 NPT	6,000 (414)	555749
JIC-4	1/4 in-18 NPT	6,000 (414)	556762
JIC-5	1/8 in-27 NPTF	5,000 (345)	125572
JIC-5	1/4 in-18 NPTF	5,000 (345)	117455
JIC-5	1/4 in-18 NPT	5,000 (345)	119998
JIC-5	3/8 in-18 NPT	5,000 (345)	122406
JIC-5	1/2 in-20 SAE-ORB	6,000 (414)	127130
JIC-6	1/4 in-18 NPTF	4,500 (310)	101909
JIC-6	1/4 in-18 NPT	6,000 (414)	122722
JIC-6	1/4 in-18 NPT	5,000 (345)	116704
JIC-6	3/8 in-18 NPT	5,000 (345)	114337
JIC-6	3/8 in-18 NPT	5,000 (345)	117832
JIC-6	1/2 in-14 NPT	6,000 (414)	16V432
JIC-6	7/16 in-20 SAE-ORB (Fluoroelastomer)	6,000 (414)	122720
JIC-6	9/16 in-18 SAE-ORB (Buna-N)	6,000 (414)	129763
JIC-6	9/16 in-18 SAE-ORB (Fluoroelastomer)	6,000 (414)	127131
JIC-8	1/4 in-18 NPT	5,000 (345)	121310
JIC-8	1/4 in-18 NPT	4,500 (310)	122992
JIC-8	1/4 in-18 NPT	5,000 (345)	116703
JIC-8	3/8 in-18 NPT	4,500 (310)	117833
JIC-8	3/8 in-18 NPT	5,000 (345)	121311
JIC-8	1/2 in-14 NPT	5,000 (345)	121319
JIC-8	1/2 in-14 NPT	6,000 (414)	124287
JIC-8	3/4 in-14 NPT	5,500 (379)	124286
JIC-8	3/4 in-14 NPT	5,000 (345)	124913
JIC-8 (Long Leg)	3/4 in-16 SAE-ORB (Buna-N)	6,000 (414)	122970
JIC-8	9/16 in-18 SAE-ORB (Buna-N)	4,500 (310)	120185
JIC-10	1/4 in-18 NPT	5,000 (345)	116702
JIC-10	3/8 in-18 NPT	5,000 (345)	116765



555749



117832



129763

INSTALLATION ACCESSORIES – STEEL JIC FITTINGS

ORDERING OPTIONS

JIC FITTINGS – CARBON STEEL

JIC MALE STRAIGHT ADAPTERS (CONT.)

Male Thread (A)	Male Thread (B)	Maximum Pressure PSI (Bar)	Part Number
JIC-10	1/2 in-14 NPT	5,000 (345)	15Y925
JIC-10	1/2 in-14 NPT	4,000 (276)	C20768
JIC-10	3/4 in-14 NPT	5,000 (345)	15Y934
JIC-10	1 in-11.5 NPT	4,500 (310)	130992
JIC-12	3/8 in-18 NPT	4,500 (310)	116766
JIC-12	1/2 in-14 NPT	5,000 (345)	132440
JIC-12	3/4 in-14 NPT	5,000 (345)	124406
JIC-12	3/4 in-14 NPT	3,500 (241)	C20708
JIC-12	1 in-11.5 NPT	5,000 (345)	123135
JIC-16	1/2 in-14 NPT	4,500 (310)	124288
JIC-16	1/2 in-14 NPT	4,500 (310)	125662
JIC-16	3/4 in-14 NPT	4,500 (310)	125661
JIC-16	1 in-11.5 NPT	5,000 (345)	123854
JIC-16	1.25 in-11.5 NPT	3,000 (207)	124968
JIC-20	1 in-11.5 NPT	3,500 (241)	15D936
JIC-20	1.25 in-11.5 NPT	3,000 (207)	125660

JIC MALE X NPT FEMALE STRAIGHT ADAPTER FITTINGS

Male Thread	Female Thread	Maximum Pressure PSI (Bar)	Part Number
JIC-4	1/4 in-18 NPT	6,000 (414)	127093
JIC-5	1/8 in-27 NPT	5,500 (379)	16U878
JIC-6	1/8 in-27 NPT	5,500 (379)	16U879
JIC-8	1/4 in-18 NPT	6,000 (414)	125403
JIC-8	3/4 in-18 NPTF	5,000 (345)	124903
JIC-10	1/2 in NPTF	5,000 (345)	126976

JIC FEMALE SWIVEL STRAIGHT ADAPTER FITTINGS

Useful for mounting a pressure gauge to an Electric Grease Jockey (EGJ) system.

Female Thread (A)	Female Thread (B)	Maximum Pressure PSI (Bar)	Part Number
JIC-6	1/4 in-18 NPT female	5,000 (345)	133645

JIC FEMALE SWIVEL UNION FITTINGS

Female threads both include swivel nut.

Female Thread (A)	Female Thread (B)	Maximum Pressure PSI (Bar)	Part Number
JIC-8	JIC-8	5,500 (379)	123896
JIC-10	JIC-10	5,500 (379)	123897



ORDERING OPTIONS

JIC FITTINGS – CARBON STEEL

JIC FEMALE SWIVEL BY MALE STRAIGHT ADAPTER FITTINGS

Female thread includes swivel nut.

Female Thread	Male Thread	Maximum Pressure PSI (Bar)	Part Number
JIC-4	1/8 in-27 NPT	6,000 (414)	17L875
JIC-4	1/4 in-18 NPT	6,000 (414)	17K615
JIC-5	1/8 in-27 NPT	5,000 (345)	117635
JIC-5	1/4 in-18 NPT	6,000 (414)	122963
JIC-6	1/8 in-27 NPT	5,000 (345)	117634
JIC-6	1/4 in-18 NPT	6,000 (414)	122721
JIC-6	1/4 in-18 NPT	5,000 (345)	117506
JIC-6	3/8 in-18 NPT	5,000 (345)	17V731
JIC-6	3/8 in-18 NPT	5,000 (345)	126327
JIC-6	1/2 in-14 NPT	6,000 (414)	126432
JIC-6	7/16 in-20 SAE-ORB	6,000 (414)	122717
JIC-8	1/2 in-14 NPT	5,000 (345)	126329
JIC-8	7/8 in-14 SAE-ORB	5,000 (345)	17U325
JIC-10	1/2 in-14 NPT	5,000 (345)	126330
JIC-16	1 in-11.5 NPT	3,600 (248)	124434

JIC EXPANDING BUSHINGS

Male Thread	Female Thread	Maximum Pressure PSI (Bar)	Part Number
JIC-5	JIC-8	5,000 (345)	117502
JIC-6	JIC-10	5,000 (345)	117677
JIC-6	JIC-8	5,000 (345)	122398
JIC-4	JIC-8	6,000 (414)	17L898
JIC-4	JIC-10	5,000 (345)	17L899
JIC-8	JIC-12	5,000 (345)	17U385

JIC 90° STREET ELBOWS

Male Thread	Female Thread	Maximum Pressure PSI (Bar)	Part Number
JIC-3	JIC-3	5,000 (345)	124405
JIC-4	JIC-4	7,500 (517)	122718
JIC-6	JIC-6	6,000 (414)	122719
JIC-8	JIC-8	5,000 (345)	122967
JIC-8	JIC-8	5,000 (345)	16W608

JIC 90° BULKHEAD ELBOWS

Male Thread (A)	Male Thread (B)	Maximum Pressure PSI (Bar)	Part Number
JIC-8	JIC-8	6,000 (414)	122400
JIC-8	JIC-8	6,000 (414)	17G704

INSTALLATION ACCESSORIES – STEEL JIC FITTINGS

ORDERING OPTIONS

JIC FITTINGS – CARBON STEEL

JIC MALE 90° ADAPTER ELBOWS

Male Thread (A)	Male Thread (B)	Maximum Pressure PSI (Bar)	Part Number
JIC-4	1/8 in-27 NPT	–	556763
JIC-4	1/4 in-18 NPT	–	556764
JIC-4	7/16 in-20 SAE-ORB (Fluoroelastomer)	6,000 (414)	122711
JIC-5	1/4 in-18 NPT	6,000 (414)	131236
JIC-6	1/4 in-18 NPT	6,000 (414)	122311
JIC-6	3/8 in-18 NPT	6,000 (414)	120064
JIC-6	3/8 in-18 NPT	6,000 (414)	261840
JIC-6	7/16 in-20 SAE-ORB (Buna-N)	–	110792
JIC-6	7/16 in-20 SAE-ORB (Buna-N)	4,500 (310)	19B332
JIC-6	9/16 in-18 SAE-ORB (Buna-N)	6,000 (414)	129755
JIC-6 (Long Leg)	9/16 in-18 SAE-ORB (Fluoroelastomer)	5,000 (345)	124941
JIC-6 (Long Leg)	9/16 in-18 SAE-ORB (Fluoroelastomer)	6,000 (414)	16V434
JIC-6	3/4-16 SAE-ORB	6,000 (414)	17U308
JIC-8	3/8 in-18 NPT	5,000 (345)	125926
JIC-8	3/8 in-18 NPT	6,000 (414)	125643
JIC-8	1/2 in-14 NPT	5,000 (345)	121486
JIC-8	1/2 in-14 NPT	6,000 (414)	123094
JIC-8	3/4 in-14 NPT	4,000 (276)	124905
JIC-8	9/16 in-18 SAE-ORB (Buna-N)	5,000 (345)	121321
JIC-8	9/16 in-18 SAE-ORB (Buna-N)	5,500 (379)	118896
JIC-8	3/4 in-16 SAE-ORB (Buna-N)	5,000 (345)	121312
JIC-8	3/4 in-16 SAE-ORB (Buna-N)	6,000 (414)	122968
JIC-8	7/8 in-14 SAE-ORB (Buna-N)	5,000 (345)	17U319
JIC-8	7/8 in-14 SAE-ORB (Buna-N)	5,500 (379)	122520
JIC-12	3/4 in-14 NPT	4,000 (276)	104099
JIC-12	1 in-11.5 NPT	4,000 (276)	C20694
JIC-16	1/2 in-14 NPT	4,000 (276)	120804
JIC-16	1 in-11.5 NPT	4,000 (276)	C20686

JIC MALE X NPT FEMALE 90° ADAPTER ELBOWS

Male Thread	Female Thread	Maximum Pressure PSI (Bar)	Part Number
JIC-8	1/2 in-14 NPTF	3,000 (207)	16W609
JIC-10	1/2 in-14 NPTF	3,000 (207)	16W610



ORDERING OPTIONS

JIC FITTINGS – CARBON STEEL

JIC MALE 45° ADAPTER ELBOWS

Male Thread (A)	Male Thread (B)	Maximum Pressure PSI (Bar)	Part Number
JIC-5	1/4 in-18 NPT	6,000 (414)	123788
JIC-6	1/4 in-18 NPT	6,000 (414)	123787
JIC-6	1/2 in-14 NPT	6,000 (414)	126431
JIC-6	9/16 in-18 SAE-ORB (Fluoroelastomer)	5,000 (345)	24P548
JIC-6	9/16 in-18 SAE-ORB (Buna-N)	5,000 (345)	126961
JIC-8	3/8 in-18 NPT	5,000 (345)	122533
JIC-8	1/2 in-14 NPT	5,000 (345)	117556
JIC-8	3/4 in-16 SAE-ORB (Fluoroelastomer)	6,000 (414)	17Y236
JIC-10	1/2 in-14 NPT	5,000 (345)	117557
JIC-10	3/4 in-16 SAE-ORB (Fluoroelastomer)	5,000 (345)	17Y235

JIC MALE X FEMALE 45° ELBOWS

Male Thread	Female Thread	Maximum Pressure PSI (Bar)	Part Number
JIC-5	JIC-5	5,000 (345)	127128
JIC-6	JIC-6	5,000 (345)	127129
JIC-6	JIC-6	5,000 (345)	129872
JIC-8	JIC-8	6,000 (414)	123528



JIC MALE (2) X NPT MALE RUN ADAPTER TEES

Male Thread (2)	NPT Thread	Maximum Pressure PSI (Bar)	Part Number
JIC-6	3/8 in Run	6,000 (414)	131817
JIC-8	1/2 in-14 NPTF	6,000 (414)	17V389
JIC-16	1 in Run	5,000 (345)	124408

JIC FEMALE CAPS

Thread	Maximum Pressure PSI (Bar)	Part Number
JIC-4	5,000 (345)	127325
JIC-6	5,000 (345)	127326
JIC-8	6,000 (414)	123140
JIC-8	-	120112
JIC-12	-	120170

JIC MALE X NPT MALE BULKHEAD FITTINGS

Male Thread (A)	Male Thread (B)	Maximum Pressure PSI (Bar)	Part Number
JIC-8 with nut	3/8 in-18 NPTF	6,000 (414)	122401
JIC-8 with nut	1/2 in-14 NPTF	6,000 (414)	16W611

INSTALLATION ACCESSORIES – STEEL JIC FITTINGS

ORDERING OPTIONS

JIC O-RING FACE SEAL (ORFS) ADAPTER FITTINGS

JIC MALE STRAIGHT ADAPTER

Male Thread (A)	Male Thread (B)	Maximum Pressure PSI (Bar)	Part Number
9/16-18 SAE-ORFS (Buna-N)	1/8 in NPT Male	6,000 (414)	2009011

JIC MALE 90° ADAPTER ELBOW

Male Thread (A)	Male Thread (B)	Maximum Pressure PSI (Bar)	Part Number
9/16-18 SAE-ORFS (Buna-N)	1/8 in NPT Male	6,000 (414)	2009010

INSTALLATION ACCESSORIES – STAINLESS STEEL FITTINGS



ORDERING OPTIONS

PIPE THREAD STAINLESS STEEL FITTINGS

45° STREET ELBOWS

Male Thread	Female Thread	Maximum Pressure PSI (Bar)	Part Number
1/4 in-18 NPT	1/4 in-18 NPT	5,000 (345)	113933

90° STREET ELBOWS

Male Thread	Female Thread	Maximum Pressure PSI (Bar)	Part Number
1/8 in-27 NPT	1/8 in-27 NPT	5,000 (345)	128054
1/8 in-27 NPTF	1/8 in-27 NPTF	5,000 (345)	502820
3/8 in-18 NPT	3/8 in-18 NPT	4,000 (276)	112026
3/4 in-14 NPT	3/4 in-14 NPT	3,000 (207)	122763
1 in-11.5 NPT	1 in-11.5 NPT	3,000 (207)	U70234
1.25 in-11.5 NPT	1.25 in-11.5 NPT	6,000 (414)	119900

90° STREET ELBOWS – ZERO RADIUS

Male Thread	Female Thread	Maximum Pressure PSI (Bar)	Part Number
1/8 in-27 NPT	1/8 in-27 NPT	–	297085
1/4 in-18 NPT	1/4 in-18 PTF SAE Short	9,000 (620)	166866
1/2 in-14 NPT	1/2 in-14 NPT	4,500 (310)	166242

90° MALE ELBOWS

Male Thread (A)	Male Thread (B)	Maximum Pressure PSI (Bar)	Part Number
3/8 in-18 NPT	1/4 in-18 NPT	5,000 (345)	114504
3/8 in-18 NPT	3/8 in-18 NPT	5,000 (345)	15E279
1/2 in-14 NPT	1/2 in-14 NPT	5,000 (345)	114506

HEX COUPLINGS

Female Thread	Maximum Pressure PSI (Bar)	Part Number
1/4 in-18 NPT	5,000 (345)	110336
1/2 in-14 NPT	3,000 (207)	124586

HEX NIPPLES – STANDARD AND REDUCING

Male Thread (A)	Male Thread (B)	Maximum Pressure PSI (Bar)	Part Number
1/4 in-18 NPT	1/8 in-27 NPT	6,000 (414)	111643
1/4 in-18 NPT	1/4 in-18 NPT	7,200 (496)	121907
1/2 in-14 NPT	1/2 in-14 NPT	5,000 (345)	114373
3/4 in-14 NPT	1/2 in-14 NPT	7,250 (500)	16R883
3/4 in-14 NPT	3/4 in-14 NPT	7,250 (500)	16R882
1 in-11.5 NPT	1/2 in-14 NPT	5,000 (345)	503086
1 in-11.5 NPT	3/4 in-14 NPT	6,000 (414)	131525
1 in-11.5 NPT	3/4 in-14 NPT	5,400 (372)	15M805
1 in-11.5 NPT	1 in-11.5 NPT	6,000 (414)	131524

INSTALLATION ACCESSORIES – STAINLESS STEEL FITTINGS

ORDERING OPTIONS

PIPE THREAD STAINLESS STEEL FITTINGS

REDUCING BUSHINGS

Male Thread	Female Thread	Maximum Pressure PSI (Bar)	Part Number
3/8 in-18 NPT	1/4 in-18 NPT	3,000 (207)	125214
1/2 in-14 NPT	1/4 in-18 NPT	3,000 (207)	122656
1/2 in-14 NPT	1/4 in-18 NPT	6,000 (414)	122767
3/4 in-14 NPT	1/4 in-18 NPT	6,000 (414)	15M861
3/4 in-14 NPT	1/4 in-18 NPT	5,000 (345)	516308
3/4 in-14 NPT	3/8 in-18 NPT	3,000 (207)	500352
3/4 in-14 NPT	1/2 in-14 NPT	6,000 (414)	16C475
3/4 in-14 NPT	1/2 in-14 NPT	6,000 (414)	502033
1 in-11.5 NPT	3/4 in-14 NPT	3,000 (207)	502851
1.25 in-11.5 NPT	3/4 in-14 NPT	5,000 (345)	127119

EXPANDING BUSHINGS

Male Thread	Female Thread	Maximum Pressure PSI (Bar)	Part Number
1/4 in-18 NPT	3/8 in-18 NPT	5,000 (345)	512351
1/4 in-18 NPT	1/2 in-14 NPT	5,200 (359)	16H491
1/4 in-18 NPT	1/2 in-14 NPT	3,000 (207)	124814
1/4 in-18 NPT	3/4 in-14 NPT	4,300 (296)	16J975
3/8 in-18 NPT	1/2 in-14 NPT	3,000 (207)	123024
3/4 in-14 NPT	1 in-11.5 NPT	3,600 (248)	15X886

TEE FITTINGS – MALE

Male Threads (3)	Maximum Pressure PSI (Bar)	Part Number
3/8 in-18 NPT	7,500 (517)	116400
3/4 in-14 NPT	3,000 (207)	122844

TEE FITTINGS – MALE BRANCH

Male Thread	Maximum Pressure PSI (Bar)	Part Number
1/4 in-18 NPT	5,000 (345)	185281
1/2 in-14 NPT	3,500 (241)	517434

TEE FITTINGS – MALE RUN (STREET TEES)

Male Thread	Maximum Pressure PSI (Bar)	Part Number
1/4 in-18 NPT	5,000 (345)	125215
3/8 in-18 NPTF	4,000 (276)	108673
1/2 in-14 NPT	3,000 (207)	124844
3/4 in-14 NPT	3,000 (207)	16C637
3/4 in-14 NPT	3,000 (207)	123514

CROSS FITTINGS – FFFF PORT

Female Thread	Maximum Pressure PSI (Bar)	Part Number
1/4 in-18 NPT	5,000 (345)	110191

PLUGS

Thread	Head Shape	Maximum Pressure PSI (Bar)	Part Number
1/8 in-27 NPTF	None (Socket)	7,200 (496)	555457
1/8 in-28 BSPT	None (Socket)	-	114172
1/4 in-18 PTF SAE short	None (Socket)	-	101970

INSTALLATION ACCESSORIES – STAINLESS STEEL SWIVEL ADAPTERS



ORDERING OPTIONS

SWIVEL ADAPTERS

- Female NPSM swivels allow for easy clocking of the fitting.
- Not a “live” swivel; position is stationary after tightened.

STRAIGHT STAINLESS STEEL SWIVEL ADAPTERS, MBF

Rigid Thread (Male)	Swivel Thread (Female)	Maximum Pressure PSI (Bar)	Part Number
1/4 in	1/4 in	10,000 (689)	24W865
3/8 in	1/4 in	6,000 (414)	121908
3/4 in	1/2 in	3,500 (241)	123980

STRAIGHT STAINLESS STEEL SWIVEL ADAPTERS, FBE

Rigid End (Female)	Swivel Thread (Female)	Maximum Pressure PSI (Bar)	Part Number
3/4 in	3/4 in	4,000 (276)	15X983

90° ELBOW STAINLESS STEEL SWIVEL ADAPTERS, MBF

Rigid Thread (Male)	Swivel Thread (Female)	Maximum Pressure PSI (Bar)	Part Number
1/8 in	1/4 in	5,000 (345)	114446
3/8 in	3/8 in	5,000 (345)	207123
1/2 in	1/2 in	5,000 (345)	114874

45° ELBOW STAINLESS STEEL SWIVEL ADAPTERS, MBF

Rigid Thread (Male)	Swivel Thread (Female)	Maximum Pressure PSI (Bar)	Part Number
3/8 in	3/8 in	4,600 (317)	209029

INSTALLATION ACCESSORIES – STAINLESS STEEL JIC FITTINGS

ORDERING OPTIONS

JIC FITTINGS – STAINLESS STEEL

JIC MALE 90° ADAPTER ELBOWS

Male Thread (A)	Male Thread (B)	Maximum Pressure PSI (Bar)	Part Number
JIC-5	1/4 in-18 NPT	–	114247
JIC-5	3/4 in-16 SAE-ORB (Buna-N)	5,000 (345)	123108
JIC-6	3/8 in-18 NPT	5,000 (345)	114484
JIC-6	1/4 in-18 NPT	5,000 (345)	122786
JIC-8	3/8 in-18 NPT	4,000 (276)	125297
JIC-8	3/8 in-18 NPT	6,000 (414)	125494
JIC-8	1/4 in-18 NPT	6,000 (414)	124813
JIC-8	1/2 in-14 NPT	6,000 (414)	124885
JIC-8	3/4 in-16 SAE-ORB (Fluoroelastomer)	6,000 (414)	126565
JIC-16	1/2 in-14 NPT	4,000 (276)	U70588

JIC 90° STREET ELBOWS

Male Thread	Female Thread	Maximum Pressure PSI (Bar)	Part Number
JIC-5	JIC-5	6,000 (414)	122715

JIC 45° STREET ELBOWS

Male Thread	Female Thread, with Swivel	Maximum Pressure PSI (Bar)	Part Number
JIC-4	JIC-4	–	121041
JIC-6	JIC-6	–	121042
JIC-8	JIC-8	–	121043
JIC-12	JIC-12	–	121044

JIC MALE 45° ADAPTER ELBOWS

Male Thread (A)	Male Thread (B)	Maximum Pressure PSI (Bar)	Part Number
JIC-8	1/2 in-14 NPT	–	123106
JIC-10	1/2 in-14 NPT	–	123107

JIC FEMALE STRAIGHT ADAPTER FITTINGS

Female Thread (A)	Female Thread (B)	Maximum Pressure PSI (Bar)	Part Number
JIC-6	1/4 in-18 NPT	5,000 (345)	124820
JIC-6	1/2 in-14 NPT	5,000 (345)	124152
JIC-10	1/2 in-14 NPT	5,000 (345)	126979

JIC NIPPLES – STANDARD AND REDUCING

Male Thread (A)	Male Thread (B)	Maximum Pressure PSI (Bar)	Part Number
JIC-3	JIC-3	5,000 (345)	124845
JIC-4	JIC-4	9,000 (621)	123553
JIC-5	JIC-5	7,200 (496)	124726
JIC-6	JIC-6	7,200 (496)	125779
JIC-8	JIC-6	7,200 (496)	126366
JIC-8	JIC-8	7,200 (496)	125781
JIC-12	JIC-8	3,500 (241)	129133
JIC-12	JIC-12	6,000 (414)	124435
JIC-16	JIC-16	4,800 (331)	126418



ORDERING OPTIONS

JIC FITTINGS – STAINLESS STEEL

JIC MALE STRAIGHT ADAPTER NIPPLES

Male Thread (A)	Male Thread (B)	Maximum Pressure PSI (Bar)	Part Number
JIC-3	1/4 in-18 NPT	6,000 (414)	124846
JIC-4	1/8 in-27 NPT	6,000 (414)	124803
JIC-4	1/4 in-18 NPT	6,000 (414)	124961
JIC-5	1/4 in-18 NPT	4,500 (310)	123596
JIC-5	1/4 in-18 NPT	6,000 (414)	122727
JIC-5	7/16 in-20 SAE-ORB (Buna-N)	6,000 (414)	124221
JIC-6	1/4 in-18 NPT	4,500 (310)	123597
JIC-6	1/4 in-18 NPT	6,000 (414)	122991
JIC-6	3/8 in-18 NPT	5,000 (345)	112100
JIC-6	3/4 in-16 SAE-ORB (Buna-N)	6,000 (414)	126170
JIC-8	1/4 in-18 NPT	4,500 (310)	123598
JIC-8	3/4 in-14 NPT	2,500 (172)	125296
JIC-8	1/2 in-14 NPT	6,000 (414)	16C398
JIC-8	3/8 in-18 NPT	6,000 (414)	16C399
JIC-8	3/4 in-16 SAE-ORB (Fluoroelastomer)	7,200 (496)	126562
JIC-10	1/4 in-18 NPT	4,500 (310)	123599
JIC-10	1/2 in-14 NPT	3,000 (207)	503931
JIC-12	1/4 in-18 NPT	5,000 (345)	116712
JIC-12	3/4 in-14 NPT	5,000 (345)	123417
JIC-12	3/4 in-14 NPT	5,000 (345)	15M863
JIC-12	1 in-11.5 NPT	5,000 (345)	123136
JIC-16	3/4 in-14 NPT	5,000 (345)	124315
JIC-16	1 in-11.5 NPT	4,500 (310)	U70933

JIC NPT MALE X JIC FEMALE STRAIGHT ADAPTER FITTINGS

Male Thread	Female Thread	Maximum Pressure PSI (Bar)	Part Number
1/4 in-18 NPT	JIC-4	6,000 (414)	126243
1/4 in-18 NPT	JIC-5	6,000 (414)	122737
1/4 in-18 NPT	JIC-5	5,000 (345)	262205
1/4 in-18 NPT	JIC-6	5,000 (345)	262206
1/4 in-18 NPT	JIC-6	5,000 (345)	122961
1/4 in-18 NPT	JIC-8	5,000 (345)	262208
1/4 in-18 NPT	JIC-10	5,000 (345)	262210
1/2 in-14 NPT	JIC-8	5,000 (345)	127600
3/4 in-14 NPT	JIC-12	5,000 (345)	124433

JIC MALE X NPT FEMALE STRAIGHT ADAPTER FITTINGS

Male Thread	Female Thread	Maximum Pressure PSI (Bar)	Part Number
JIC-6	1/4 in-18 NPTF	6,000 (414)	124967
JIC-8	1/4 in-18 NPT	4,500 (310)	129134
JIC-8	1/2 in-14 NPTF	5,000 (345)	126975

INSTALLATION ACCESSORIES – STAINLESS STEEL JIC FITTINGS

ORDERING OPTIONS

JIC FITTINGS – STAINLESS STEEL

JIC REDUCING BUSHINGS

Male Thread	Female Thread	Maximum Pressure PSI (Bar)	Part Number
JIC-12	JIC-8	3,500 (241)	17T211

JIC EXPANDING BUSHINGS

Male Thread	Female Thread	Maximum Pressure PSI (Bar)	Part Number
JIC-8	JIC-12	3,500 (241)	128442
JIC-5	JIC-8	5,000 (345)	16A361
JIC-6	JIC-10	5,000 (345)	16A362

JIC BULKHEAD ELBOW FITTING

- SST elbow with 1.25 inch (32 mm) hex head
- Use with nut 102300 and washer 114830 (nut and washer are carbon steel)

Male Thread	Female Thread	Maximum Pressure PSI (Bar)	Part Number
JIC-6 (Long Leg)	3/8 in-18 NPT	5,000 (345)	192889

INSTALLATION ACCESSORIES – CHECK VALVES



Incoming flow pushes the ball from the valve seat, compressing the spring and permitting lubricant to flow through the check valve to the lube points. When flow stops, the spring expands, re-seating the ball and creating a positive seal. Compact and easy to install. Include a symbol stamped on the body to indicate flow direction.

Single Ball Check Valves

- Designed with the standard ball and spring principle.
- Positive seal prevents leakage and backflow.

TYPICAL APPLICATIONS TECHNICAL SPECIFICATIONS

- Compressor lubrication systems
- Hydraulic systems

TYPICAL FLUIDS

- Oil or Grease

Thread Type	Maximum Temperature	Maximum Operating Pressure	Materials			
			Body	Spring	Ball	O-Ring
Pipe Thread	500°F (206°C)	5,000 PSI (345)	Steel	Steel	Steel	N/A
SAE-ORB	250°F (121°C)	3,500 PSI (242)	303 SST	Steel	Steel	See Below
BSPB	250°F (121°C)	5,000 PSI (345)	Steel	Steel	Steel	See Below

ORDERING OPTIONS

PIPE THREAD SINGLE BALL CHECK VALVES

OUTLET CHECK VALVES

- May be installed in the outlet ports of MSP, MHH and MX/MXP divider valves.
- Male inlet, female outlet.

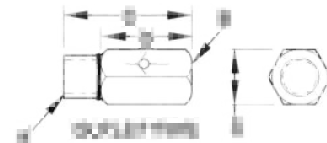

Part Number	Male Inlet Thread (A)	Female Outlet Thread (B)	Nominal Cracking Pressure PSI (bar)	Dimensions in (mm)		
				Length (C)	Length (D)	Hex (E)
563195	1/8-27 NPTF	1/8-27 NPSF	10 (0.7)	1.28 (32.5)	0.91 (23.0)	0.56 (14.2)
563196	1/8-27 NPTF	1/8-27 NPSF	35 (2.4)	1.28 (32.5)	0.91 (23.0)	0.56 (14.2)
563197	1/8-27 NPTF	1/8-27 NPSF	130 (9.0)	1.28 (32.5)	0.91 (23.0)	0.56 (14.2)
563198	1/8-27 NPTF	1/8-27 NPSF	250 (17.2)	1.28 (32.5)	0.91 (23.0)	0.56 (14.2)
563206	1/4-18 NPTF	1/4-18 NPSF	10 (0.7)	1.63 (41.4)	1.13 (28.7)	0.69 (17.5)
563207	1/4-18 NPTF	1/4-18 NPSF	35 (2.4)	1.63 (41.4)	1.13 (28.7)	0.69 (17.5)

INLET CHECK VALVES

- Typically installed in the inlet ports of MSP, MHH and MX/MXP divider valves, or into a lubrication point.
- Female inlet, male outlet.
- "Reverse" check valves.

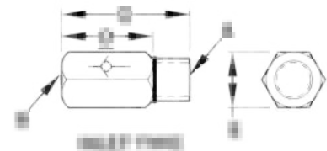

Part Number	Female Inlet Thread (A)	Male Outlet Thread (B)	Nominal Cracking Pressure PSI (bar)	Dimensions in (mm)		
				Length (C)	Length (D)	Hex (E)
563199	1/8-27 NPSF	1/8-27 NPTF	15 (1.0)	1.31 (33.3)	0.94 (23.8)	0.56 (14.2)
563200	1/8-27 NPSF	1/8-27 NPTF	35 (2.4)	1.31 (33.3)	0.94 (23.8)	0.56 (14.2)
563201	1/8-27 NPSF	1/8-27 NPTF	60 (4.1)	1.31 (33.3)	0.94 (23.8)	0.56 (14.2)
563210	1/4-18 NPSF	1/4-18 PTF SAE short	10 (0.7)	1.75 (44.5)	1.25 (31.8)	0.69 (17.5)
563211	1/4-18 NPSF	1/4-18 PTF SAE short	35 (2.4)	1.75 (44.5)	1.25 (31.8)	0.69 (17.5)

INSTALLATION ACCESSORIES – CHECK VALVES

ORDERING OPTIONS

SINGLE BALL CHECK VALVES (CONT.)

SAE-ORB THREAD

OUTLET CHECK VALVES

Part Number	Male Inlet Thread (A)	Female Outlet Thread (B)	Nominal Cracking Pressure PSI (bar)	Dimensions in (mm)			O-Ring Material
				Length (C)	Length (D)	Hex (E)	
563054	7/16-20	7/16-20	35 (2.4)	1.56 (39.7)	1.20 (30.5)	0.63 (15.9)	Buna-N
563055	9/16-18	9/16-18	35 (2.4)	1.69 (42.8)	1.30 (33.0)	0.75 (19.1)	Fluoroelastomer

BSPP “G” THREAD

OUTLET CHECK VALVE

Part Number	Male Inlet Thread (A)	Female Outlet Thread (B)	Nominal Cracking Pressure PSI (bar)	Dimensions in (mm)			O-Ring Material
				Length (C)	Length (D)	Hex (E)	
258299	1/8 in-28	1/8 in-28	35 (2.4)	1.27 (32.3)	0.97 (24.6)	0.63 (15.9)	Buna-N

INLET CHECK VALVES

Part Number	Female Inlet Thread (A)	Male Outlet Thread (B)	Nominal Cracking Pressure PSI (bar)	Dimensions in (mm)			O-Ring Material
				Length (C)	Length (D)	Hex (E)	
563057	1/4 in-19	1/4 in-19	35 (2.4)	1.79 (45.5)	1.35 (34.3)	1.0 (25.4)	Buna-N (Buna-N)

Double Ball Check Valves

- Designed for high pressure applications where reverse leakage must be kept to a minimum.
- Also used to isolate parts of circuits and to prevent fluid drainage due to gravity.
- A relatively stiff bias spring in these valves serves to increase the reliability of circuits designed to detect a blockage or reduction in lubricant flow.

TYPICAL APPLICATIONS

- Compressor lubrication systems
- Hydraulic systems

TYPICAL FLUIDS

- Oil or Grease

TECHNICAL SPECIFICATIONS

Maximum Temperature	400°F (204°C)
Maximum Operating Pressure	8,000 PSI (552 bar)
Nominal Cracking Pressure	110 PSI (7.6 bar)
Materials	316 SST Body, 440 SST Balls, SST Spring, Fluoroelastomer O-Ring

ORDERING OPTIONS

DOUBLE BALL CHECK VALVES

Part Number	Female Inlet Thread (A)	Male Outlet Thread (B)	Dimensions in (mm)	
			Length (C)	Length (E)
562647	1/8-27 NPTF	1/8-27 NPTF	3.0 (76.2)	0.75 (19.1)
562649	1/4-18 NPTF	1/8-27 NPTF	3.2 (81.5)	0.75 (19.1)

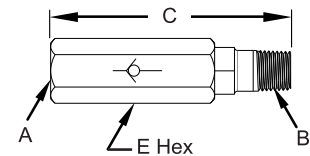

INSTALLATION ACCESSORIES – SOFT SEAT CHECK VALVES – STAINLESS STEEL



Soft Seat Check Valves – Stainless Steel

- A poppet and soft ball check design improves check valve reliability.
- The "double ball" check valve contains a poppet and soft ball check, as well as a conventional steel ball back-up for added protection.
- Provides optimum sealing against reverse flow.

TYPICAL APPLICATIONS

- Lubrication systems
- Hydraulic systems

TYPICAL FLUIDS

- Oil or Grease

TECHNICAL SPECIFICATIONS

Maximum Temperature	400°F (204°C)
Maximum Operating Pressure	7,500 PSI (517 bar)
Materials	316 SST Body, Steel Springs – See below for ball(s)

ORDERING OPTIONS

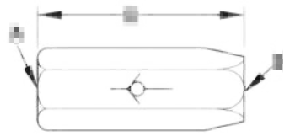

Style A

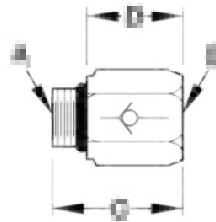

Style B

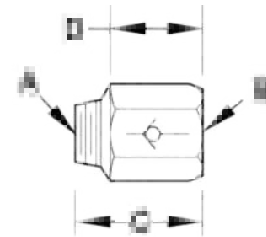

Style C

SOFT SEAT CHECK VALVES – STAINLESS STEEL

STYLE A

- Female both ends.
- Tapered at outlet end to help identify flow direction.
- 50 PSI (3.5 bar) nominal cracking pressure.

Part Number	Type	Female Inlet Thread (A)	Female Outlet Thread (B)	Dimensions in (mm)		Ball Material
				Length (C)	Hex	
563046	Single	1/4-18 NPSF	1/4-18 NPSF	1.94 (49.3)	0.75 (19.1)	Fluoroelastomer
563060	Double	1/4-18 NPSF	1/4-18 NPSF	2.41 (61.2)	0.75 (19.1)	Buna-N*
563061	Double	1/4-18 NPSF	1/4-18 NPSF	2.41 (61.2)	0.75 (19.1)	Fluoroelastomer*

*Second ball is made of chrome steel.

STYLE B

- Includes Buna-N O-Ring at base of male thread.
- 32 PSI (2 bar) nominal cracking pressure.

Part Number	Male Inlet Thread (A)	Female Outlet Thread (B)	Dimensions in (mm)			Ball Material
			Length (C)	Length (D)	Hex	
563052	7/16-20 SAE Male	7/16-20 SAE	1.56 (39.6)	1.20 (30.4)	0.63 (15.9)	Fluoroelastomer

INSTALLATION ACCESSORIES – SOFT SEAT CHECK VALVES – CARBON STEEL

Soft Seat Check Valves – Carbon Steel

- A poppet and soft ball check design improves check valve reliability.
- Provides optimum sealing against reverse flow.

TYPICAL APPLICATIONS

- Lubrication systems
- Hydraulic systems

TYPICAL FLUIDS

- Oil or Grease

TECHNICAL SPECIFICATIONS

Maximum Temperature	400°F (204°C)
Maximum Operating Pressure	100 PSI (6.9 bar)
Cracking Pressure	32 PSI (2 bar)
Materials	Steel Body and Spring, Fluoroelastomer Ball

ORDERING OPTIONS

SOFT SEAT CHECK VALVES – CARBON STEEL

STYLE C

- 50 PSI (3.5 bar) nominal cracking pressure.

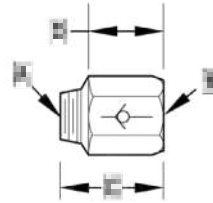

Part Number	Female Inlet Thread (A)	Female Outlet Thread (B)	Dimensions in (mm)		
			Length (C)	Length (D)	Hex
563048	1/8-27 NPTF	1/8-27 NPSF	1.13 (28.7)	0.94 (23.9)	0.56 (14.2)

INSTALLATION ACCESSORIES – TWIN TANDEM CHECK VALVES



Twin Tandem Check Valves

- Incorporates both a garter type check valve and a standard ball and spring type check valve.
- The garter check valve has a soft seat elastic garter band that permits uninterrupted flow and seals unwanted back flow.

TYPICAL APPLICATIONS

- Lubrication systems
- Hydraulic systems

TYPICAL FLUIDS

- Oil or Grease

TECHNICAL SPECIFICATIONS

Maximum Temperature	400°F (204°C)
Maximum Operating Pressure	5,000 PSI (345 bar)
Nominal Cracking Pressure	75 ± 15 psi (5.2 ± 1.0 bar)
Materials	303 SST Body, 440 SST Ball, 302 SST Spring, Aluminum Gaskets, Fluoroelastomer Garter

ORDERING OPTIONS

TANDEM TWIN CHECK VALVES

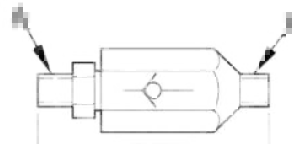

Part Number	Male Inlet Thread (A)	Male Outlet Thread (B)	Dimensions in (mm)	
			Length	Hex
563203	1/4-18 PTF SAE short	1/8-27 NPTF	2.25 (57.2)	0.68 (17.1)

Note: for applications requiring a 90 degree connection, order 1/4 in elbow fitting 166866 separately.

INSTALLATION ACCESSORIES – BRASS DOUBLE BALL CHECK VALVE

Brass Double Ball Check Valve

- Typically used as inlet check valve.
- Two of the conventional spring & ball type checks are combined to provide maximum protection against system back flow/leakage.

TYPICAL APPLICATIONS

- Lubrication systems
- Hydraulic systems

TYPICAL FLUIDS

- Oil or Grease

TECHNICAL SPECIFICATIONS

Maximum Temperature	500°F (260°C)
Maximum Operating Pressure	3,800 PSI (262 bar)
Nominal Cracking Pressure	40 +/- 20 PSI (2.8 +/- 1.4 bar)
Materials	Brass Body, 440 SST Balls, 302 SST Springs

ORDERING OPTIONS

DOUBLE BRASS BALL CHECK VALVE



Part Number	Male Inlet Thread (A)	Male Outlet Thread (B)	Dimensions in (mm)	
			Length	Hex
563058	1/4 in NPSF	1/4-18 PTF SAE short	3.56 (90.4)	0.75 (19.1)

INSTALLATION ACCESSORIES – PRESSURE SENSORS



PRESSURE SENSORS FOR LUBRICATION SYSTEMS

Provide positive indication to the lubrication controller when a Parallel system has achieved the required pressure. Can also be used to trigger a high pressure alarm when used in Series Progressive systems (requires capable controller).

ORDERING OPTIONS

PRESSURE SWITCHES

- Options for pressures up to 5,800 PSI.
- May be wired Normally Open or Normally Closed.



24K414

Part Number	Rising Pressure Range PSI (Bar)	Pressure Connection	Electrical Connection	Enclosure Rating	Approvals	Switch Type	Voltage Range	Special Features
24K414	290 to 5,800 (20 to 400)	1/4 NPT male	M12	IP67	UL, CE	PNP transistor	9.6 to 32 VDC	M12 connector allows for plug-and-play wiring to G3 Max via cable 124333 (sold separately); LED lights visually display pressure switch status. Instruction Manual number 3A1827.
557829	400 to 4,700 (28 to 324)	1/4 NPT male	Flying Leads – 5 ft (1.5 m)	NEMA 4	UL, CE	SPDT	Up to 30 VDC; Up to 250 VAC	Factory set at 1,150 PSI (79 Bar); replacement part for Modu-Flo kit 563328, and Miniature Meter-Flo (MMF) pump packages. Instruction Manual number 3A0471.
115124	280 to 3,000 (19 to 207)	1/4 NPT female	Flying Leads – 18 in (46 cm)	NEMA 3	CE	SPDT	Up to 250 VDC; Up to 480 VAC	Factory set at 2,500 PSI (172 Bar)
24N181	580 to 5,800 (40 to 400)	1/4 NPT female	DIN Form A	NEMA 4, IP65	CE	SPDT	Up to 24 VDC; Up to 250 VAC	Factory set at 3,500 PSI (241 Bar)
25U286	3,500 (241)	1/4 or 3/8 NPT male	DT04-3P	NEMA 6, IP67	UL, CSA, CE, CRN, RoHS	SPDT	Up to 24 VDC; Up to 125 VAC	Factory set at 3,500 PSI (241 Bar), non-adjustable, 1/4 NPT male. Kit includes switch, mating 10 ft (3 m) wiring harness, and 3/8 NPT male x 1/4 NPT female adapter fitting.

PRESSURE TRANSDUCERS

- Analog signal communicates real time pressure level.
- Compatible with G3 Max Gen 2 pumps (AC and DC), and GLC X lubrication controller.

Part Number	Rising Pressure Range PSI (Bar)	Pressure Connection	Electrical Connection	Enclosure Rating	Approvals	Output Signal	Excitation Voltage	Special Features
25U285	0 to 5,000 (0 to 345)	3/8 NPT male – mates to GL-1 and GCI injectors	DT04-3P	NEMA 4X, IP67	CE, RoHS, UL	0.5 to 4.5 VDC	9 to 36 VDC	Use with GLC X controller to add analog pressure sensing to EDS and Fire-Ball pumps! Also compatible with G3 Max Gen 2 pumps. Kit includes transducer and mating 10 ft (3 m) wiring harness. G3 Max requires connector 124594.
2010651	0 to 5,000 (0 to 345)	1/4 NPT male – mates to GL-32 and GL-43 injectors	M12	NEMA 6X, IP67	CE, RoHS, UL	0.5 to 4.5 VDC	9 to 36 VDC	M12 connector pin assignments match "P" input of the G3 Max Gen 2 pumps; use cable 124333 for easy, plug-and-play wiring. Use cable 126331 to connect to GLC X controller.

INSTALLATION ACCESSORIES – PRESSURE GAUGES

ORDERING OPTIONS



AIR PRESSURE GAUGES

Part Number	Scale psi (bar/MPa)	Dial Diameter in (mm)	Fill	Case Material	Fitting Material	Fitting Location	Graco Branded	Application Notes
110319	0-200 (14/1.4)	1.5 (40)	Dry	Steel	Brass	Bottom	Yes	1/8 in NPT
100960	0-200 (14/1.4)	2 (50)	Dry		Brass	Bottom	Yes	1/4 in NPT
24E691	0-200 (14/1.4)	2 (50)	Dry		Brass	Bottom	Yes	1/4 in NPT, suitable for use with air and oil
116383	0-160 (-/-)	0.91(23)	Dry	Black ABS	Brass	Center-Back	No	1/8 in NPT, "micro" air pressure gauge
127379	0-160 (11/-)	1.5 (40)	Dry	Steel	Steel	Center-Back	No	1/8 in NPT
101689	0-200 (14/1.4)	2 (50)	Dry		Brass	Center-Back	Yes	1/4 in NPT

OIL AND GREASE PRESSURE GAUGES

• 1/4 in NPT male thread

Part Number	Scale psi (bar/MPa)	Dial Diameter in (mm)	Fill	Case Material	Fitting Material	Fitting Location	Graco Branded	Application Notes
24E691	0-200 (14/1.4)	2 (50)	Dry	Steel	Brass	Bottom	Yes	Suitable for use with Air and Oil
112564	0-1500 (100/10)	2.5 (63)	Liquid	SST	SST	Bottom	Yes	Provides better resolution at lower pressures
17L706	0-3000 (210/-)	2.5 (63)	Liquid	SST	SST	Bottom	Yes	Tee into G3 or G-Mini outlet.
2007096	0-5000 (350/35)	2.5 (63)	Liquid	SST	Bronze	Bottom	Yes	Included with Lube Master (LMxxxx) packages. Tee into G3 or G-Mini outlet.
551387	0-10,000 (690/69)	2.5 (63)	Liquid	SST	SST	Bottom	Yes	
112567	0-1500 (100/10)	2.5 (63)	Liquid	SST	Brass	Center-Back	Yes	Option for G3 vent valves on oil systems
557278	0-1500 (100/-)	2 (50)	Dry	Steel	Brass	Center-Back	No	Included with Miniature Meter-Flo (MMxxxx) packages
557864	0-3000 (210/-)	2.44 (62)	Dry	Steel	Bronze	Center-Back	No	Included with most Modu-Flo baseplate manifold kits, and many other Trabon pump packages
557866	0-3000 (210/-)	2.5 (63)	Liquid	SST	Brass	Center-Back	No	Installed option on some MVB packages
113641	0-3000 (200/20)	2.5 (63)	Liquid	SST	SST	Center-Back	Yes	Option for G3 vent valves on grease systems
115523	0-5000 (350/35)	2.5 (63)	Liquid	SST	Brass	Center-Back	Yes	Option for G3 vent valves on grease systems
113654	0-5000 (350/35)	2.5 (63)	Liquid	SST	SST	Center-Back	Yes	Option for G3 vent valves on grease systems
558298	0-10,000 (690/-)	2.5 (63)	Liquid	SST	SST	Center-Back	No	Installed option on some MVB packages

G-SERIES GAUGE KITS

• For use with series progressive divider valve or pump-to-point systems.

Part Number	Description
25U706	G-Series Gauge and Relief Valve Adapter Kit – includes 5,000 psi/350 bar gauge (2007096), street cross fitting (133643) and 1/4 NPT x NPSM swivel fitting (156823). Allows connection of gauge, relief valve and outlet fitting to pump outlet. NPSM swivel fitting installs in the G-Series pump outlet for easy clocking of the complete assembly. Relief valve sold separately – choose from one of the options on page 24.
2008155	G-Series Gauge and Return-to-Reservoir Adjustable Pressure Relieve Valve Kit – includes all of the parts in kit 25U706, plus adjustable PRV with elbows and tubing to plumb back to the reservoir of a G3 or G-Mini pump.

INSTALLATION ACCESSORIES – OTHER FITTINGS AND ACCESSORIES



ORDERING OPTIONS

MOUNTING WELD STUDS

Part Number	Thread	Thread Length
127512	1/4 in-20	0.71 in (18.0 mm)
127513	1/4 in-20	0.96 in (24.4 mm)
127514	1/4 in-20	1.2 in (30.5 mm)
17D024	1/4 in-20	2 in (50.8 mm)
17D023	3/8 in-16	1.25 in (30.5)



127512

MOUNTING WELD STUD FIXTURE

Part Number	Description
17J423	MSP/MHH Weld Stud Fixture – attach studs to the jig before welding to ensure perfect alignment. For 3-valve to 8-valve assemblies

P-CLAMPS

Part Number	Clamp ID inches (mm)	Mounting Hole
128006	0.38 (9.5)	0.40 in (10.3 mm)
127012	0.38 (9.5)	0.28 in (7.1 mm)
557944	0.50 (12.7)	0.28 in (7.1 mm)
127515	1.50 (38.1)	0.28 in (7.1 mm)



128006

FILL STUDS FOR GREASE RESERVOIRS

Part Number	Description
24M644	1/4 QD style with cap, 1/4 in NPT male thread – accessory for G3 and G-Mini pumps
557874	1/4 QD style, 1/4 in NPT male thread
557880	1/4 QD style, 3/8 in NPT male thread – replacement part for Grease Jockey (pneumatic), LubePro and CDS pumps
557875	Cap for 1/4 QD, black PVC with retaining loop
100854	"Giant" Button Head, 1/4 in NPT male thread
557374	Trabon-style Fill Stud
557373	Cap for Trabon-style Fill Stud



24M644

MATING COUPLERS

Part Number	Description
121474	1/4 in QD x 1/4 in NPT female coupler. Mates to 1/4 QD fill studs above.
200021	Giant Button Head coupler, 1/8 NPT female
558906	Mates to Trabon-style Fill Stud 557374



121474

INSTALLATION ACCESSORIES – OTHER FITTINGS AND ACCESSORIES

ORDERING OPTIONS

GREASE NIPPLES (ZERKS)

Part Number	Description
557969	Grease Zerk Cover
555888	1/8 in NPT, 5,000 PSI, straight, leakproof
556429	1/8 in NPTF, 5,000 PSI, 90°, leakproof, Buna-N
100054	1/8 in NPTF, 10,000 PSI, straight with check ball
557968	1/8 in NPT, 65°
100848	1/4 in NPT, 10,000 psi, 67° with check ball
130883	M5, 10,000 PSI, straight with check ball
15M037	Press-to-Fit – 1/8 in NPSF female fitting – use to replace drive-type Zerks



557969



555888

GREASE NIPPLE ADAPTERS (ZERK ADAPTERS)

· Use with drive type or metric threaded grease nipples if re-tapping is not possible.

Part Number	Description
556448	Straight, wrench-on, 1/8 in NPT female – after being placed on a Zerk and a mating fitting is installed, adapter cannot be removed from the grease nipple.
563776	90°, press-on, includes 3/16 inch compression fitting



556448

CABLE TIES

Part Number	Description
563770	Standard duty, black nylon, 11.5 in length, 100 pack
17K063	Heavy duty, black nylon, UV Resistant, 14 in length x 0.30 in width, 100 pack

VICE BLOCK TOOL

Part Number	Description
127145	For use with 1/8 in, 1/4 in, 3/8 in and 1/2 in ID hose

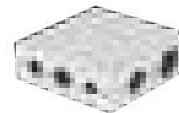

127145

INSTALLATION ACCESSORIES – HOSES, TUBING AND FITTINGS

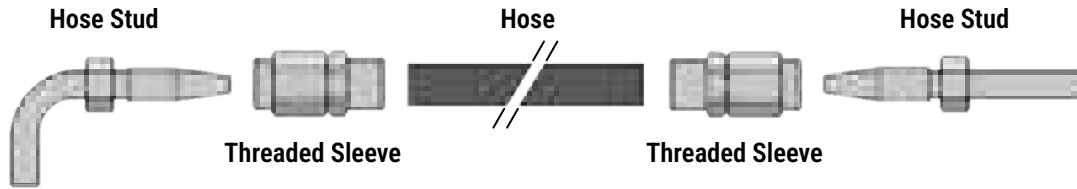

ORDERING OPTIONS

8.6 MM OD HOSES AND ACCESSORIES

8.6 MM OD HOSE

- Polyamid inner
- Braided synthetic fiber reinforcement
- Anti-abrasion polyurethane cover, stabilized to UV rays
- 5/32 in (4 mm) ID
- Maximum working pressure 4,000 psi (276 bar)
- Working temperature range: -40°F to 212°F (-40°C to 100°C)

	Part Number	Length ft (m)
	Non-Filled	
	17S552	82 (25)
	17S553	164 (50)
	17S554	328 (100)
	17S555	656 (200)
Filled with NLGI #2 Grease		
	133281	32.8 (10)
	133282	98.4 (30)
	130938	164 (50)



SPIRAL WRAP HOSE GUARD

- Nylon
- 9 mm ID
- Working temperature range: -40°F to 212°F (-40°C to 100°C)

	Part Number	Length ft (m)
		123147

6 MM OD HOSE STUDS

- For use with compression fittings
- Field-installable hose end fittings for use with 8.6 mm OD hose
- Maximum working pressure 3,000 psi (207 bar)

	Part Number	Description
	17R565	Straight hose stud
	17R566	90° elbow hose stud
	2013442	45° elbow hose stud
	17L648	Threaded sleeve



INSTALLATION ACCESSORIES – HOSES, TUBING AND FITTINGS

ORDERING OPTIONS

8.6 MM OD HOSES AND ACCESSORIES (CONT.)







6 MM OD G-LOCK HOSE STUDS

- For use with 6 mm G-Lock push-to-connect fittings
- Field-installable hose end fittings for use with 8.6 mm OD hose
- Maximum working pressure 2,000 psi (138 bar)

	Part Number	Description
	17L649	Straight hose stud
	17L650	90° elbow hose stud
	17L648	Threaded sleeve

6 MM COMPRESSION FITTINGS

- Mate to 6 mm OD hose studs 17R565, 17R566 and 2013442
- Can also be used with 6 mm OD steel tubing
- Not for use with nylon or other plastic tubing
- Maximum working pressure 3,000 psi (207 bar)

	Part Number	Description
	17L550	CSP outlet fitting with check valve
	17T780	1/8 NPT male straight
	17T781	1/8 NPT male elbow 90°
	17T782	1/4 NPT male straight
	17T783	1/4 NPT male elbow 90°
	17L548	1/8 BSPT male straight
	17L546	1/8 BSPT male elbow 90°
	17R571	1/4 BSPT male straight
	17R572	1/4 BSPT male 90°
	17R573	M6 tapered male straight
	17R574	M6 tapered male elbow 90°
	17R575	M8 tapered male straight
	17R576	M8 tapered male elbow 90°
	17R577	M10 tapered male straight
	17R578	M10 tapered male elbow 90°







ORDERING OPTIONS

8.6 MM OD HOSES AND ACCESSORIES (CONT.)



6 MM G-LOCK FITTINGS

- Mate to 6 mm OD G-Lock hose studs 17L649 and 17L680
- Push-to-connect for quick and easy installation
- Not for use with tubing
- Maximum working pressure 2,000 psi (138 bar)

	Part Number	Description
	17L545	1/8 BSPT male straight
	17L449	1/8 BSPT male elbow 90°
	17R569	1/4 BSPT male straight
Image Coming Soon	17R570	1/4 BSPT male elbow 90°
	17Y689	1/8 NPT male straight
Image Coming Soon	17L458	CSP outlet fitting with check valve

THREADED FITTINGS

- Field-installable hose end fittings for use with 8.6 mm OD hose
- With swivel, for ease of installation
- Maximum working pressure 3,000 psi (207 bar)

	Part Number	Description
	17Y690	JIC-4 female, with sleeve
	17Y691	1/8-27 NPT male, with sleeve

INSTALLATION ACCESSORIES – HOSES, TUBING AND FITTINGS

ORDERING OPTIONS

1/8 IN ID HOSES AND ACCESSORIES

1/8 IN ID HOSE

- Thermoplastic hose
- Braided with polyurethane cover
- 0.327 in (8.3 mm) OD
- Maximum working pressure 3,000 psi (207 bar)
- Maximum temperature 212°F (100°C)

	Part Number	Length ft (m)
	128679	82 (25)
	128572	100 (30)
	128573	125 (38)
	128570	200 (61)
	128571	400 (122)
	128862	2000 (610)

SPIRAL WRAP HOSE GUARD

- Nylon
- 3/8 in (9.5 mm) ID
- 0.055 in (1.4 mm) wall thickness
- Working temperature range: -40°F to 212°F (-40°C to 100°C)

	Part Number	Length ft (m)
	128579	160 (49)
	2006075	200 (60)
	128580	325 (99)

THREADED FITTINGS

- Field-installable hose end fittings for use with 1/8 in ID hose
- With swivel, for ease of installation
- Maximum working pressure 3,000 psi (207 bar)

	Part Number	Description
	128561	JIC-4 female, with sleeve
	128562	1/8-27 NPT male, with sleeve
	133090	1/8-27 NPT male, with sleeve, Stainless Steel







ORDERING OPTIONS

1/8 IN ID HOSES AND ACCESSORIES (CONT.)



1/4 IN OD G-LOCK HOSE STUDS

- For use with 1/4 in diameter G-Lock push-to-connect fittings
- Field-installable hose end fittings for use with 1/8 in ID hose
- Maximum working pressure 3,000 psi (207 bar)



	Part Number	Description
	25M496	90° elbow hose stud, with sleeve
	17L437	90° elbow hose stud, bare (without sleeve)
	25M497	Straight hose stud, with sleeve
	17L438	Straight hose stud, bare (without sleeve)
	17L647	Threaded sleeve

1/4 IN DIAMETER G-LOCK FITTINGS

- Mate to 1/4 in OD G-Lock hose studs (above)
- Push-to-connect for quick and easy installation
- Not for use with tubing
- Maximum working pressure 2,000 psi (138 bar)

	Part Number	Description
	17L442	1/8 NPT male straight
	17L547	1/4 NPT male straight
	17L441	CSP outlet fitting with check valve

1/8 IN ID HOSE ACCESSORIES

	Part Number	Description
	128006	P-Clamp
	17L941	Hose Repair Kit – includes qty 4 of fitting 128561 and two JIC-4 nipples.

INSTALLATION ACCESSORIES – HOSES, TUBING AND FITTINGS

ORDERING OPTIONS

1/4 IN ID HOSES AND ACCESSORIES

1/4 IN ID HOSE

- Thermoplastic hose
- Braided with polyurethane cover
- 0.476 in (12.1 mm) OD
- Maximum working pressure 2,750 psi (207 bar)
- Maximum temperature 212°F (100°C)

	Part Number	Length ft (m)
	128682	60 (18)
	128680	80 (24)
	128572	100 (30)
	128573	125 (38)
	130281	250 (76)
	131164	500 (152)

SPIRAL WRAP HOSE GUARD

- Nylon
- 1/2 in (12.7 mm) ID
- 0.051 inch (1.3 mm) wall thickness
- Working temperature range: -40°F to 212°F (-40°C to 100°C)



	Part Number	Length ft (m)
	128581	80 (24)
	128582	100 (30)

THREADED FITTINGS

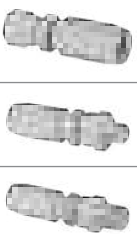
- Field-installable hose end fittings for use with 1/4 in ID hose
- With swivel, for ease of installation
- Maximum working pressure 3,000 psi (207 bar)

	Part Number	Description
	128563	JIC-4 female, with sleeve
	128565	1/8-27 NPT male, with sleeve
	128564	1/4-18 NPT male, with sleeve

1/4 IN ID HOSE ACCESSORIES



	Part Number	Description
	557944	P-Clamp, 9/32 in mounting hole
	17L942	Hose Repair Kit – includes qty 4 of fitting 128563 and two JIC-4 nipples.



ORDERING OPTIONS

3/8 IN ID HOSE

- Synthetic rubber inner
- Braided steel wire reinforcement
- Synthetic rubber cover
- 3/4 in (4 mm) OD,
- Maximum working pressure: 4,750 psi (330 bar),
- Working temperature range: -40°F to 212°F (-40°C to 100°C)

	Part Number	Description
	17P336	100 ft (30 m)
	17P337	Field-Installable Swivel Hose End Fitting, 3/8 in ID Hose, #6 JIC, SAE 9/16-18 female
	117832	Straight adapter fitting, JIC-6 male x 3/8 in NPT male

Refer to the "Steel Fittings" section for more JIC fitting options.

6 MM OD TUBING AND ACCESSORIES

6 MM OD TUBING

- Nylon
- 0.12 in (3 mm) ID
- Maximum working pressure: 1,000 psi (69 bar)
- Working temperature range: -40°F to 212°F (-40°C to 100°C)

	Part Number	Length ft (m)
	17S556	82 (25)
	17S557	164 (50)
	17S558	328 (100)
	17S559	656 (200)
	25N013	82 (25) – Filled with Lithium EP2 grease

INSTALLATION ACCESSORIES – HOSES, TUBING AND FITTINGS

ORDERING OPTIONS

6 MM OD TUBING AND ACCESSORIES (CONT.)



6 MM PUSH-TO-CONNECT FITTINGS

- Push-to-connect for quick and easy installation
- For Nylon tubing only; not for use with metal tubing or hose studs
- Maximum working pressure: 1,000 psi (69 bar)

	Part Number	Description
	130966	1/8 NPT male straight
	17R567	1/8 BSPT male straight
	17L457	M6 tapered male straight
	17L456	M8 tapered male straight
	17L455	M10 tapered male straight
	130965	1/8 NPT male elbow 90°
	17R568	1/8 BSPT male elbow 90°
	17L448	M6 tapered male elbow 90°
	17L447	M8 tapered male elbow 90°
	17L446	M10 tapered male elbow 90°
	17L543	CSP outlet fitting with check, 800 psi (55 bar) maximum
Image Coming Soon	17V721	Straight union fitting

6 MM COMPRESSION FITTINGS

- Compression fit ensures a secure connection
- Suitable for use with 6 mm OD nylon or steel tubing
- Maximum working pressure: 3,000 psi (207 bar)

	Part Number	Description
	17T783	1/4 NPT male elbow 90°
	17R572	1/4 BSPT male elbow 90°





ORDERING OPTIONS



1/8 IN OD TUBING AND ACCESSORIES

1/8 IN OD TUBING

- Nylon
- 0.073 inch (1.85 mm) ID
- Maximum working pressure: 625 psi (43 bar)
- Working temperature range: -60°F to 200°F (-51°C to 93°C)

	Part Number	Description
	127554	Tube, 1/8 in OD, 625 psi, 100 ft (30 m)
	127551	1/8 NPT compression fitting

1/8 IN STREET ELBOWS – ZERO RADIUS

	Part Number	Description
	15K783	90° Elbow – 1/8-27 PTF SAE short
	557395	45° Elbow – 1/8-27 NPT

3/16 IN OD TUBING AND ACCESSORIES

3/16 IN OD TUBING

- Grease Jockey Lube Point Tubing
- Also used with air/oil spray nozzle 562994
- Nylon
- 1/10 inch (2.54 mm) ID
- Maximum working pressure: 800 psi (55 bar)
- Working temperature range: -60°F to 200°F (-51°C to 93°C)

SINGLE NON-FILLED TUBES – BLACK

	Part Number	Length ft (m)
	561131	60 (18)
	16A169	100 (30)
	128268	500 (152)
	2008771	5,000 (1,524)

SINGLE FILLED (CHARGED) TUBES – BLACK

	Part Number	Length ft (m)
	564086	10 (3)
	563786	15 (4.6)
	15W165	30 (9)

INSTALLATION ACCESSORIES – HOSES, TUBING AND FITTINGS

ORDERING OPTIONS

3/16 IN OD TUBING AND ACCESSORIES (CONT.)

SINGLE FILLED (CHARGED) TUBES – ORANGE

· Filled (charged) with NLGI #00 grease

Image Coming Soon	Part Number	Length ft (m)
	563789	15 (4.6)

DOUBLE TUBES – ONE BLACK, ONE ORANGE WITH BLACK COVER

	Part Number	Length ft (m)
	16A171	100 (30)

DOUBLE FILLED (CHARGED) TUBES – ONE BLACK, ONE ORANGE WITH BLACK COVER

· Filled (charged) with NLGI #00 grease

	Part Number	Length ft (m)
	563984	10 (3)
	563788	15 (4.6)
	564090	30 (9)

TRIPLE TUBES – ONE BLACK, ONE ORANGE, ONE BLUE WITH BLACK COVER

	Part Number	Length ft (m)
	16A172	100 (30)

TRIPLE FILLED (CHARGED) TUBES – ONE BLACK, ONE ORANGE, ONE BLUE WITH BLACK COVER

· Filled (charged) with NLGI #00 grease

	Part Number	Length ft (m)
	563994	10 (3)
	563783	15 (4.6)
	563796	30 (9)









ORDERING OPTIONS

3/16 IN OD TUBING AND ACCESSORIES (CONT.)

BRASS COMPRESSION FITTINGS FOR 3/16 IN OD NYLON OR COPPER TUBING

• With captive ferrule for easy alignment

	Part Number	Description
	556644	Straight Connector, 1/8 in-27 NPT male
	562995	Straight Connector, 1/4 in-28 SAE tapered male
	556638	Elbow, 1/8 in-27 NPT male
	556647	Union Fitting
	556642	Straight Connector, 1/8 in-27 NPT female
	556660	Spare Nut, with captive ferrule
	563776	Zerk Adapter, elbow, wrench-on aluminum body with brass compression fitting

PUSH-TO-CONNECT FITTINGS FOR 3/16 IN OD NYLON TUBING

• Not for use with metal tubing or hose studs

	Part Number	Description
	556661	Straight Connector, 1/8 in-27 NPT male

INSTALLATION ACCESSORIES – HOSES, TUBING AND FITTINGS

ORDERING OPTIONS



1/4 IN OD TUBING AND ACCESSORIES

1/4 IN OD TUBING

- Nylon
- 0.150 inch (3.9 mm) ID
- Maximum working pressure: 625 psi (43 bar)
- Working temperature range: -60°F to 200°F (-51°C to 93°C)



	Part Number	Length ft (m)
	127555	100 (30)

BRASS COMPRESSION FITTINGS FOR 1/4 IN OD NYLON OR COPPER TUBING

	Part Number	Description
	127553	Straight Connector, 1/8 in-27 NPT male, with captive ferrule
	556634	Elbow, 1/8 in-27 NPTF male, 3-piece
	555726	Elbow, 1/4 in-18 NPTF male, 3-piece

PUSH-TO-CONNECT FITTINGS FOR 1/4 IN OD NYLON TUBING

- Not for use with metal tubing or hose studs

	Part Number	Description
	17L653	Straight Connector, 1/8 in-27 NPT male
	17L652	Elbow, 1/8 in-27 NPTF male
	17L440	CSP outlet fitting with check, p-t-c

COMPRESSION FITTING FOR 1/4 IN OD NYLON TUBING

- For nylon tubing only; not for use with metal tubing or hose studs
- Carbon steel body and nut
- Brass compression ferrule and clamping ring
- Maximum working pressure 1,000 psi (69 bar)

	Part Number	Description
	17L692	CSP outlet fitting with check, compression



ORDERING OPTIONS

5/16 IN OD TUBING AND ACCESSORIES

5/16 IN OD TUBING

- Grease Jockey Mainline Tubing
- Nylon
- 0.191 in (4.85 mm) ID
- Maximum working pressure 375 psi (26 bar)
- Working temperature range: -40°F to 200°F (-40°C to 93°C)

	Part Number	Length ft (m)
	561134	30 (9)
	25T847	40 (12)
	561132	60 (18)
	561133	164 (50)

BRASS COMPRESSION FITTINGS FOR 5/16 IN OD NYLON OR COPPER TUBING

- With captive ferrule for easy alignment

	Part Number	Description
	556656	Tube Insert – required at each connection to support inside of tubing when compressed
	557963	20-pack of tube insert 556656
	556643	Straight Connector, 1/8 in-27 NPT female
	556645	Straight Connector, 1/8 in-27 NPT male
	556646	Straight Connector, 1/4 in-18 NPT male
	556639	Elbow, 1/8 in-27 NPTF male
	556640	Elbow, 1/4 in-18 NPTF male
	556636	Tee, 5/16 in tube female runs x 1/8 in-27 NPTF male branch
	556648	Union Fitting
	556637	Union Tee
	556666	Spare Nut, with captive ferrule

BULKHEAD COUPLING

- Brass
- 1/8 in NPTF female both ends
- Maximum working pressure 375 psi (26 bar)
- Male thread 5/8 in-18 (15.9 mm) diameter
- 1.5 in (38.1 mm) length
- Maximum surface thickness 0.89 in (22.6 mm)
- Maximum pressure 1000 psi (68 bar)

	Part Number	Description
	557950	1/8 in NPTF female

MANZEL®

	Page
MBL Box Lubricators	226-230
MB Specialty Box Lubricators	231
GBL 7500 Pump	232
Model HP-15" High Pressure Lubricators	233
Model HP-50" High Pressure Lubricators	234
MVB Pump	235
MVB Box Lubricator Configurator	236
Lube-Line Alert	237
Pneumatic/Electric Lube Sentry Valve	238
Balancing Valve	239



MANZEL® MBL BOX LUBRICATORS

Features and Benefits

- Provide a proven, cost-effective way to assemble customized oil systems that meet specific requirements by using standard modular components
- Increase opportunities to standardize lube system components and reduce lube maintenance and service costs
- Dependable and backed by the industry's most comprehensive international distributor network—with application expertise, parts stocks, and factory-trained service nearby, wherever you are located

TYPICAL APPLICATIONS

- Provide lubrication to cylinder walls, bearings and other moving parts of equipment such as refineries, injection and storage, general manufacturing, air systems, and food processing equipment

TYPICAL FLUIDS

- Mineral oil base or synthetics



Application	Industry	Use
Compressors	Petrochemical, Refineries, Gas Transmission, Injection and Storage, Cold Storage, General Manufacturing, Air Systems	Lubricate cylinder walls and piston shaft packing
Edgers, Planers, Band Saws	Lumber	Lubricate slides and ways. Blade coolant.
Mixers	Rubber	Used in the bleeding process and to lubricate dust stop seals
Can Lid Presses	Food Processing	Lubricate high-speed bearings
Band Saws	Lumber	Saw guides

MODULARITY

Force Feed Box Lubricators provide true modularity that permits customizing a pump-to-point lubrication system from off-shelf components. The modular variables consist of the following categories of components:

- Pumps
- Reservoir
- Reservoir Heaters
- Reservoir Oil Level Controls
- Drives
- Shaft Rotation Alarm
- Motor and Motor Mounting Bases

In addition to these Force Feed Box Lubricator components, Graco offers a complete line of auxiliary equipment. Also, MBL pumping packages can be used with divider valves in a series progressive installation. Graco's performance-proven products that may be used with Modular Box Lubricators are listed on the next page along with the respective literature number.

DESCRIPTION

A basic pump-to-point system is shown in the illustration which depicts six pumps mounted on a common reservoir from which each pump is dispensing oil to a single lubrication point. These pumps are operated by individual cams on one common drive shaft.

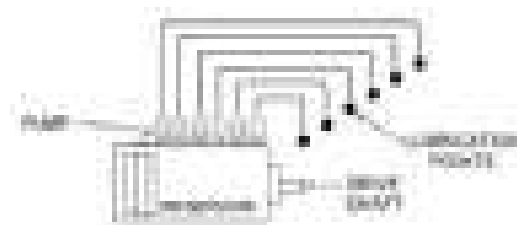

PUMP-TO-POINT SYSTEM

INTERCHANGEABILITY, CONVERSION AND RETROFITS

Graco GBL 7500 Pumps have been designed to be easily interchangeable with other manufacturers' pumps. For details contact your local Graco representative or call on us for system design and application assistance.



MBL FORCE FEED BOX LUBRICATOR = TRUE MODULARITY

Wide choice of standard modular components helps you meet application requirements more exactly without the added costs of a custom system.

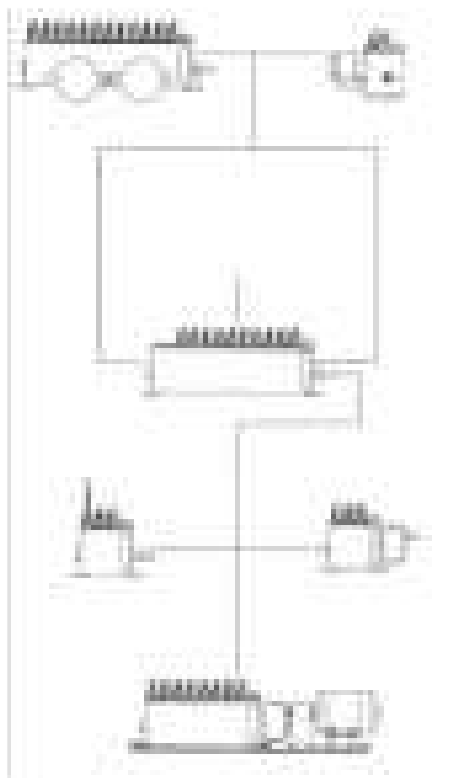

PUMPS

Graco GBL 7500 pumps for pressures up to 7,500 psi.

24J391 – GBL 7500 Suction Pump, 3/16 in

24J392 – GBL 7500 Suction Pump, 1/4 in

24J393 – GBL 7500 Suction Pump, 3/8 in

- Ideal for heavy duty applications
- Interchangeable with pumps from competitive lubricators
- Suction (vacuum feed) pumps are available installed
- Pressure feed and gravity feed pumps are sold separately
- See Instruction Manual 3A2257 for more information

Alarm Pump

Shaft Rotation/Low Level alarm based on GBL 7500 pump.

- Available as part number 24K466.
- Mounts in a pump slot
- Order separately for field installation.

RESERVOIRS AND MOUNTING BASES

Eight reservoir capacities are available to hold from 4 to 40 pints and accommodate from 1 to 24 pumps. Blank cover assemblies included on unused pump stations. Eight sizes of motor mounting bases are available to accommodate the various reservoir sizes.

RESERVOIR ACCESSORIES

Automatic fill, low level, and electric heater options.

DRIVE OPTIONS

Over a dozen drive options are available from direct drive to a reduction ratio of 400:1. Options provide left- or right-hand end of reservoir mounting, end rotary drives, end ratchet drives and gear reducers. For details, see pages 228 and 229. See page 231 for MB60 (60:1) and MB118 (118:1) specialty box lubricators

MOTORS

Single- and three-phase motors are available at ratings of 1/3, 1/4 and 1/2 HP, for 115/230 volt or 230/460 volt, in explosion-proof, TEFC or TENV configuration. Some motor configurations are available foot-mounted and/or face-mounted.

“SMART” PART NUMBERS

- Graco part numbers are 6-digits long
- MBL Smart Part Numbers start with “MB”
- The next four letters each specify one or more options:
 - Option A: Reservoir and Motor Mounting Base
 - Option B: Pump Style and Monitor
 - Option C: Pump Quantity
 - Option D: Drive
- MBabcd – replace lower case letters with selections offered in **Smart Menu Code** to form a **Smart Part Number**

LITERATURE

L54000	Lube Line Alert
L15831	Lube Sentry
L15825	Check Valves
L15200	In-Line Filters
L10103	MH Modular Divider Valves
3A2100	Modular Box Lubricator (MBL) Instruction Manual
3A2257	GBL7500 pumps Instruction Manual
352389	Manzel MB60 and MB118 flyer
3A2953	Center Drive Box Lubricator Instruction Manual

MANZEL® MBL PUMP/RESERVOIR COMBINATIONS

NOTE: LH option currently available only on MBL-G01, G02, G03, and G04 drives. All part numbers on the chart below use "OA" to indicate assemblies with NO pumps. Refer to Smart Code ordering details.

= Not compatible

		Reservoirs Without Motor Mounting Bases								Reservoirs Combined With Motor Mounting Bases							
		T1	T2	T3	T4	T5	T6	T7	T8	T1 + P1	T2 + P2	T3 + P3	T4 + P4	T5 + P5	T6 + P6	T7 + P7	T8 + P8
		4 pint / 2 feed	6 pint / 3 feed	8 pint / 5 feed	12 pint / 8 feed	16 pint / 12 feed	24 pint / 16 feed	32 pint / 20 feed	40 pint / 24 feed	4 pint / 2 feed	6 pint / 3 feed	8 pint / 5 feed	12 pint / 8 feed	16 pint / 12 feed	24 pint / 16 feed	32 pint / 20 feed	40 pint / 24 feed
G01R	Direct, 1:1	MBA0AA	MBB0AA	MBC0AA	MBD0AA	MBE0AA	MBF0AA	MBG0AA	MBH0AA								
G02R	End Ratchet	MBA0AB	MBB0AB														
G03R	37.5:1 Ratchet	MBA0AC	MBB0AC														
G04R	75:1 Ratchet	MBA0AD	MBB0AD														
G01L	Direct, 1:1	MBA0AE	MBB0AE	MBC0AE	MBD0AE	MBE0AE	MBF0AE	MBG0AE	MBH0AE								
G02L	End Ratchet	MBA0AF	MBB0AF														
G03L	37.5:1 Ratchet	MBA0AG	MBB0AG														
G04L	75:1 Ratchet	MBA0AH	MBB0AH														
G05R	25:1 End Rotary	MBA0AJ	MBB0AJ	MBC0AJ	MBD0AJ	MBE0AJ											
G06R	50:1 End Rotary	MBA0AK	MBB0AK	MBC0AK	MBD0AK	MBE0AK				MBJ0AK	MBK0AK	MBL0AK	MBM0AK	MBN0AK			
G07R	100:1 End Rotary	MBA0AL	MBB0AL	MBC0AL	MBD0AL	MBE0AL				MBJ0AL	MBK0AL	MBL0AL	MBM0AL	MBN0AL			
G08R	200:1 End Rotary	MBA0AM	MBB0AM	MBC0AM	MBD0AM	MBE0AM				MBJ0AM	MBK0AM	MBL0AM	MBM0AM	MBN0AM			
G09R	400:1 End Rotary	MBA0AN	MBB0AN	MBC0AN	MBD0AN	MBE0AN				MBJ0AN	MBK0AN	MBL0AN	MBM0AN	MBN0AN			
G18R	400:1 Heavy Duty														MBP0AY	MBR0AY	MBS0AY

COMPRESSOR LUBRICATION

MANZEL® MBL BOX LUBRICATOR CONFIGURATOR



COMPRESSOR LUBRICATION

MBL SMART CODE ORDERING MENU

MB - X - X - X - X

Reservoir (Smart Code Option A)

Code	Former Code(s)	Description	Code	Former Code(s)	Description
A	T1	4 pt, 2 pump stations max	J	T1 and P1	4 pt, 2 pump stations max, motor mount base
B	T2	6 pt, 3 pump stations max	K	T2 and P2	6 pt, 3 pump stations max, motor mount base
C	T3	8 pt, 5 pump stations max	L	T3 and P3	8 pt, 5 pump stations max, motor mount base
D	T4	12 pt, 8 pump stations max	M	T4 and P4	12 pt, 8 pump stations max, motor mount base
E	T5	16 pt, 12 pump stations max	N	T5 and P5	16 pt, 12 pump stations max, motor mount base
F	T6	24 pt, 16 pump stations max	P	T6 and P6	24 pt, 16 pump stations max, motor mount base*
G	T7	32 pt, 20 pump stations max	R	T7 and P7	32 pt, 20 pump stations max, motor mount base*
H	T8	40 pt, 24 pump stations max	S	T8 and P8	40 pt, 24 pump stations max, motor mount base*

*Cannot use double reduction or right angle drives.

Pump Size – GBL 7500 Suction Pumps (Smart Code Option B)

Code	Former Code(s)	Description
0	00	No pumps
1	76/88B	3/16 in Suction Pump 24J391
2	76/88C	1/4 in Suction Pump 24J392
3	76/88E	3/8 in Suction Pump 24J393
4	76/88B and F3	3/16 in Suction Pump plus RENS Level Controller
5	76/88C and F3	1/4 in Suction Pump plus RENS Level Controller
6	76/88E and F3	3/8 in Suction Pump plus RENS Level Controller
7	76/88B and F4	3/16 in Suction Pump plus GARZO Level Controller
8	76/88C and F4	1/4 in Suction Pump plus GARZO Level Controller
9	76/88E and F4	3/8 in Suction Pump plus GARZO Level Controller

NOTES:

1. When pump quantity is less than maximum pump stations of specified reservoir, a blank cover assembly is installed at Graco.
2. When low level is specified, deduct one pump for each option.
3. When ordering a ratchet drive, the maximum number of pumps allowable is 3.

Pump Quantity (Smart Code Option C)

Code	Qty	Code	Qty	Code	Qty	Code	Qty	Code	Qty	Code	Qty
A	0	E	4	J	8	N	12	T	16	X	20
B	1	F	5	K	9	P	13	U	17	Y	21
C	2	G	6	L	10	R	14	V	18	Z	22
D	3	H	7	M	11	S	15	W	19		

Drive Options (Smart Code Option D)

Code	Former Code	Description	Code	Former Code	Description
A	G01R	Direct End Rotary (50 rpm max)	J	G05R	Double Reduction End Rotary 25:1
B	G02R	End Ratchet (without drive arm 563005)	K	G06R	Double Reduction End Rotary 50:1
C	G03R	End Rotary Ratchet 37-1/2:1 – max input of 800 RPM	L	G07R	Double Reduction End Rotary 100:1
D	G04R	End Rotary Ratchet 75:1 – max input of 800 RPM	M	G08R	Double Reduction End Rotary 200:1
E	G01L	Direct End Rotary	N	G09R	Double Reduction End Rotary 400:1
F	G02L	End Ratchet (without drive arm 563005)	Y	G18R	400:1 Ratio Gear Reducer**
G	G03L	End Rotary Ratchet 37-1/2:1 – max input of 800 RPM			
H	G04L	End Rotary Ratchet 75:1 – max input of 800 RPM			

**Drive requires motor mounting base; can only be used with reservoir options P, R, and S.

MANZEL® MBL BOX LUBRICATOR ACCESSORIES

ORDERING OPTIONS

MANZEL® MBL BOX LUBRICATOR MOTORS

Part Number	Description
558289	M2 – 1/4 hp, 1,725 rpm, 115/230V, 1 ph., TENV, Foot-Mounted (56F)
558293	M3 – 1/4 hp, 1,725 rpm, 115/230V, 1 ph., Hazardous Area, Class 1, Group D, Foot-Mounted (56F)
558290	M5 – 1/4 hp, 1,725 rpm, 230/460V, 3 ph., TENV, Foot-Mounted (56F)
558292	M6 – 1/4 hp, 1,725 rpm, 230/460V, 3 ph., Hazardous Area, Class 1, Group D, Foot-Mounted (56F)
558294	M7 – 1/2 hp, 1,725 rpm, 115/230V, 1 ph., Hazardous Area, Class 1, Group C, Severe Duty, Tropical Insulation, Face-Mounted or Foot-mounted (56C with feet)
558291	M10 – 1/2 hp, 1,725 rpm, 230/460V, 3 ph., 60Hz, Class 1, Group D, Face-Mounted (56C)
557271	M11 – 1/2 hp, 1,725 rpm, 115/230V, 1 ph., 60Hz, TEFC, Face-Mounted (56C)
557270	M12 – 1/2 hp, 1,725 rpm, 230/460V, 3 ph., 60Hz, TEFC, Face-Mounted (56C)

Note: Heavy Duty drive "Y" (G18R) requires 56C, face-mount. Normally a 1/2 hp motor would be used because more pumps are being operated by the HD drives.

AUTO-FILL OPTIONS

Part Number	Description
559037	F1 Gravity Supply

Note: F2 – obsolete, use F1 instead. F3 – ordered with pumps (see page 133). F4 – ordered with pumps (see page 133).

LOW LEVEL SWITCHES

Part Number	Description
563013	L1 – Low Level Switch Hazardous Area. Class 1, Group C and D; Class 2 Group, E, F and G.
564015	L2 – Low Level, 10 Watts at 120 VAC, SPST Reed Switch, NC

SHAFT ROTATION ARM

Part Number	Description
24K466	GBL 7500 Suction Alarm Pump

HEATER OPTIONS

Part Number	Description
557207	120 VAC Electric Heater, Hazardous Area, Class 1, Group B, one-prong heater. Can be installed in 1 in NPT port on MBL reservoirs.
557208	240 VAC Electric Heater, Hazardous Area, Class 1, Group B, one-prong heater. Can be installed in 1 in NPT port on MBL reservoirs.

Note: Former codes H3, H4 and H6 use 557207. For H1, H2 and H5, contact factory for details about part number 564058 (two prong heater) Class 1, Group D

MANZEL® MB SPECIALTY BOX LUBRICATORS



LONG LIFE AND DURABILITY

Leak-proof welded steel reservoir and solid steel, hardened cams. Double-supported cam shafts and gear drives to eliminate cantilevered assemblies and high load capacity needle bearings and ball bearings.

MB118 BOX LUBRICATORS

- "Model 55" 118:1 reduction drive
- 4 or 6 pump stations max, use with any GBL 7500 pumps
- Maximum input speed 1,800 rpm
- Instruction Manual number 3A3006

MB60 BOX LUBRICATORS

- Rear 60:1 reduction drive
- Perfect for bolt-on gas compressor box lubrication solutions
- 2 or 4 pump stations max, use with gravity-fed or pressure-fed GBL 7500 pumps
- Maximum input speed 1,800 rpm
- Instruction Manual numbers 3A2953, 334210



ORDERING OPTIONS

MB118 BOX LUBRICATORS

4 PINT (1.9 L), 4 PUMP CAPACITY

For triplex mud pumps

Drive End		GBL 7500 Pumps*		Maximum Output Pressure
Left Hand	Right Hand	Quantity	Size	
25R513	24W633	0	N/A	N/A
25R557	24W636	3	1/4 in	6,000 psi (414 bar)

6 PINT (2.8 L), 6 PUMP CAPACITY

For quintuplex mud pumps

Right Hand Drive End	GBL 7500 Pumps*		Maximum Output Pressure
	Quantity	Size	
24W634	0	N/A	N/A
24W635	5	1/4 in	6,000 psi (414 bar)

MB60 BOX LUBRICATORS

2 PINT (0.95 L), 2 PUMP CAPACITY

Left Rear Drive

Mount Orientation		GBL 7500 Pumps*	
Floor	Wall	Quantity	Size
24V068	25A071	0	N/A

6 PINT (2.8 L), 4 PUMP CAPACITY

Center Rear Drive

Drive Shaft		GBL 7500 Pumps*	
Keyway	Tang	Quantity	Size
24U750	24N724	0	N/A

*See page 228 for GBL 7500 part numbers and more tech specs, including metric conversions.

MANZEL® GBL 7500 PUMP

Features and Benefits

Each GBL 7500 single-piston pump is mechanically driven from a camshaft in the reservoir. They are adjustable from 1 to 27 drops per stroke and develop pressures up to 7500 psi (517 bar), depending on the piston size. All working parts are totally enclosed away from dirt, water, and impurities and are self-lubricated at all times by the fluid in the reservoir. Rugged construction for high performance and durability with easy to adjust pump output.

TYPICAL APPLICATIONS

- Compressors

TYPICAL FLUIDS

- Mineral or synthetic oil



Suction
24J391



Pressure
24J397

TECHNICAL SPECIFICATIONS

Piston Size		Max Outlet Pressure			Drops/Stroke		Cubic Inch/Stroke		Cubic cm/Stroke		Strokes/minute	
inches	mm	PSI	MPa	bar	Min.	Max.	Min.	Max.	Min.	Max.	Min.	Max.
3/16	4.8	7500	51.7	517	0	7	0	0.014	0	0.229	3	50
1/4	6.4	6000	41.4	414	0	12	0	0.024	0	0.393	3	50
3/8	9.5	3500	24.1	241	0	27	0	0.054	0	0.885	3	50

ORDERING OPTIONS

GBL 7500

Part Number	Description
24J391	3/16 in (4.8 mm) suction
24J392	1/4 in (6.4 mm) suction
24J393	3/8 in (9.5 mm) suction
24J394	3/16 in (4.8 mm) gravity
24J395	1/4 in (6.4 mm) gravity
24J396	3/8 in (9.5 mm) gravity
24J397	3/16 in (4.8 mm) pressure
24J398	1/4 in (6.4 mm) pressure
24J399	3/8 in (9.5 mm) pressure
24K466	Suction alarm pump

GBL ACCESSORIES AND SPARE PARTS

Part Number	Description
564332	Outlet Check Valve Assembly – maintains prime when changing out pumps
126070	Replacement Pump Gasket – used by all pumps
24T306	Sight Glass Replacement Kit – for use with suction, gravity and alarm pumps
563101	Replacement Suction Strainer – for use with suction and alarm pumps

MODEL HP-15™ HIGH PRESSURE LUBRICATORS



Features and Benefits

The high pressure lubricator comprises one to six integral sight and pump assemblies in a cast iron reservoir. The unit is designed for direct connection to an electric motor/speed reducer power source. A Manzel® terminal check valve is recommended in the lubrication system. When required to maintain proper oil viscosity, the reservoir can be fitted with an electric heater.

TYPICAL APPLICATIONS

- Multi-stage gas compression

TYPICAL FLUIDS

- Mineral or synthetic oil

TECHNICAL SPECIFICATIONS

Number of Feeds	Max. Pressure	Reservoir Capacity (Quarts) (1)	Plunger Diameter (inches)	Drops Per Stroke		Cubic Inches Per Stroke		Cubic cm Per Stroke		Strokes Per Minute	
				Min.	Max.	Min.	Max.	Min.	Max.	Min.	Max.
1-6	18,000	7	1/4	1	4	0.002	0.008	0.033	0.113	3	36

ORDERING OPTIONS

Part Number	Description
562951	HP-15 pump
564151	HP-15 sight glass kit – includes sight “glass” made of polyamide, o-ring and rubber plug
563113	HP-15 plunger and cylinder assembly
564336	Check valve – 3/8 in OD tube compression fittings on both ends. Use in line or as the lubrication point.



562951

MANZEL® HP-50™ HIGH PRESSURE LUBRICATOR

Features and Benefits

- Operating pressures to 60,000 psi for lubricating compressor and circulator cylinder walls, heavily loaded bearings and other moving parts
- Single plunger force feed design is highly efficient for injecting lubricants and/or compatible fluids into high pressure systems
- Vacuum sight feeds on self-contained pumping units show output of lubricant to individual lubrication points
- All working parts are totally enclosed and self-lubricated
- Individual pumping units easily removed for service
- Feed rate infinitely variable from minimum to maximum with simple hand adjustment

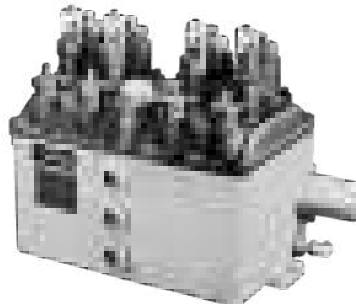

TYPICAL APPLICATIONS

- Compressors and industrial equipment

TYPICAL FLUIDS

- Mineral or synthetic oil

TECHNICAL SPECIFICATIONS

Number of Feeds	Max. Pressure	Reservoir Capacity (Quarts) (1)	Plunger Diameter (Inches)	Drops Per Stroke		Cubic Inches Per Stroke		Cubic cm Per Stroke		Strokes Per Minute	
				Min.	Max.	Min.	Max.	Min.	Max.	Min.	Max.
1-4	60,000	9	1/4	1	4	0.002	0.008	0.033	0.113	3	36

ORDERING OPTIONS

HP-50 PUMP

Part Number	Description
562952	HP-50 Pump Assembly

HP-50 LUBRICATOR BOXES

Part Number	Description
564276	HP-50 Lubricator without Pumps or Options
562925	HP-50 Lubricator with 4 Pumps
562926	HP-50 Lubricator with 2 Pumps
562927	HP-50 Lubricator with 4 Pumps, Provision for Flange Mounted Auto Fill, and Nitrogen Purge Port
562928	HP-50 Lubricator with 4 Pumps, Low Level and Shaft Rotation Alarm
562929	HP-50 Lubricator with 4 Pumps, Provisions for Flange Mounted Auto Fill and Low Level in Fill Plate
564277	HP-50 Lubricator with 4 Pumps and Steam Heater
564278	HP-50 Lubricator with 3 Pumps and Steam Heater
564279	HP-50 Lubricator with 4 Pumps, Provision for Flange Mounted Auto Fill, Nitrogen Purge and Shaft Rotation/Low Level Alarm on Left

564280	HP-50 Lubricator with 4 Pumps, Provision for Flange Mounted Auto Fill, Nitrogen Purge and Shaft Rotation/Low Level Alarm on Right
564282	HP-50 Lubricator with 4 Pumps, Shaft Rotation and Low Level Alarm
564283	HP-50 Lubricator with 4 Lubricator Boxes with 15 Pumps, Provision for Center Mounted Motor and Base
258262	HP-50 Lubricator with 4 Pumps and Low Level
258263	HP-50 Lubricator with 4 Pumps, Provisions for Flange Mounted Auto Fill and Low Level in Fill Plate, and Proximity Switch Shaft Rotation Indicator on Right

HP-50 ACCESSORIES

Part Number	Description
563111	HP-50 plunger and cylinder
564336	HP-50 check valve
558881	Electric heater, 120/240 VAC
563020	Shaft rotation alarm
563024	Low level
556808	Ren Oil Level Controller/Auto-fill, 5 psi maximum
558221	Garzo Oil Level Controller/Auto-fill, 70 psi maximum, Class 1, Groups C and D, Division I



MANZEL® MVB PUMP

Features and Benefits

The MVB lubrication system is a single line, series progressive system which divides pump output into predetermined proportional amounts and distributes these amounts to points of lubrication.

- One main supply from single pump
- Central monitoring of normal operation
- Automatic proportioning of lubricant through positive displacement valves
- Quick indication of problem areas

TYPICAL APPLICATIONS

- Compressors and reciprocating engines

TYPICAL FLUIDS

- Oil



MVB Box lubricator

TECHNICAL SPECIFICATIONS

Output per Pump in Pints (Liters) per Day

Single Camshaft rpm (pump strokes per min)	1/4 piston				3/8 piston			
	Min. Output Adj.		Max. Output Adj.		Min. Output Adj.		Max. Output Adj.	
	0.12456*(constant)		0.59832		0.29909*(constant)		1.4902	
20	2.49	(1.18)	11.97	(5.66)	5.98	(2.83)	29.92	(14.15)
30	3.74	(1.77)	17.95	(8.49)	8.97	(4.24)	44.88	(21.23)
40	4.98	(2.36)	23.93	(11.32)	11.96	(5.66)	59.84	(28.30)
50	6.23	(2.95)	29.92	(14.15)	14.95	(7.07)	74.80	(35.38)
60	7.47	(3.53)	35.90	(16.98)	17.95	(8.49)	89.76	(42.46)
70	8.72	(4.12)	41.88	(19.81)	20.94	(9.90)	104.72	(49.53)

*Constant X strokes per minute = output in pints per day. For 2 and 3 lobe cams, multiply camshaft RPM times 2 or 3.

ORDERING OPTIONS

Part Number	Description
563565	MVB 0.250 in (6.35 mm) Piston Pump
563566	MVB 0.375 in (9.53 mm) Piston Pump
563920	Seal kit for MVB pump
563919	3/8 in piston and sleeve replacement
563918	1/4 in piston and sleeve replacement
557824	25 micron filter replacement element
557827	10 micron filter replacement element

MANZEL® MVB BOX LUBRICATOR CONFIGURATOR

ORDERING MENU CODE

MV - X - X - X - X

Drive

Code (Former Code) - Description

A	(DAA) Ratchet Drive (102-2)
B	(DAB) Standard Drive (203-2)
C	(DAC) Standard Drive (207-2)
D	(DAD) Reverse Drive (303-2)

Gear Box Ratio and Mounting Base Option

Code (Former Code) - Description

A	(RAA) 1:1 Ratio Gear Box
D	(RAB) 1:2 Ratio Gear Box
E	(RAC) 2:1 Ratio Gear Box
H	(RAD) 1:3 Ratio Gear Box

Code (Former Code) - Description

J	(RAE) 3:1 Ratio Gear Box
M	(RAF) 1:4 Ratio Gear Box
N	(RAG) 4:1 Ratio Gear Box
S	(RAH) 1:8 Ratio Gear Box

Code (Former Code) - Description

T	(RAJ) 8:1 Ratio Gear Box
U	(RAJ-KOA) 8:1 Ratio Gear Box with a KOA Base
W	(RAK) 16:1 Ratio Gear Box
X	(RAK-KOA) 16:1 Ratio Gear Box with a KOA Base

Pump Station One Configuration*

Code	Cam Style	Pump Size	Gauge PSI	Relief PSI	Code	Cam Style	Pump Size	Gauge PSI	Relief PSI
A	Single Lobe	No Pump	None	None	K	Double Lobe	1/4 in	10,000	4,600
B	Single Lobe	1/4 in	None	6,400	L	Double Lobe	3/8 IN	None	1,750
C	Single Lobe	1/4 in	3,000	2,350	M	Double Lobe	3/8 IN	3,000	1,750
D	Single Lobe	1/4 in	10,000	6,400	N	Triple Lobe	No Pump	None	None
E	Single Lobe	3/8 in	None	2,350	P	Triple Lobe	1/4 in	None	3,700
F	Single Lobe	3/8 IN	3,000	2,350	R	Triple Lobe	1/4 in	3,000	2,350
G	Double Lobe	No Pump	None	None	S	Triple Lobe	1/4 in	10,000	3,700
H	Double Lobe	1/4 in	None	4,600	T	Triple Lobe	3/8 IN	None	1,450
J	Double Lobe	1/4 in	3,000	2,350	U	Triple Lobe	3/8 IN	3,000	1,450

*Former codes AOA and AOC referred to 1/4 in pump. Former codes AOB and AOD referred to 3/8 in pump. Former code POA referred to standard (2,350 psi) blowout indicator. Former codes GOA, GOB, GOC, and GOD referred to gauge options; choose from standard gauge options shown above.

Pump Station Two Configuration**

Code	Cam Style	Pump Size	Gauge PSI	Relief PSI	Code	Cam Style	Pump Size	Gauge PSI	Relief PSI
A	Single Lobe	No Pump	None	None	K	Double Lobe	1/4 in	10,000	4,600
B	Single Lobe	1/4 in	None	6,400	L	Double Lobe	3/8 IN	None	1,750
C	Single Lobe	1/4 in	3,000	2,350	M	Double Lobe	3/8 IN	3,000	1,750
D	Single Lobe	1/4 in	10,000	6,400	N	Triple Lobe	No Pump	None	None
E	Single Lobe	3/8 in	None	2,350	P	Triple Lobe	1/4 in	None	3,700
F	Single Lobe	3/8 IN	3,000	2,350	R	Triple Lobe	1/4 in	3,000	2,350
G	Double Lobe	No Pump	None	None	S	Triple Lobe	1/4 in	10,000	3,700
H	Double Lobe	1/4 in	None	4,600	T	Triple Lobe	3/8 IN	None	1,450
J	Double Lobe	1/4 in	3,000	2,350	U	Triple Lobe	3/8 IN	3,000	1,450

**Former codes BOA and BOC referred to 1/4 in pump. Former codes BOB and BOD referred to 3/8 in pump. Former code HOA referred to standard (2,350 psi) blowout indicator. Former codes JOA, JOB, JOC, and JOD referred to gauge options; choose from standard gauge options shown above.

NOTE: Motors for KOA base with 8:1 or 16:1 drives:

558289 (MOA) - 1/4 HP, 115/230 VAC, 60 Hz, single-phase, 1,725 rpm, TENV, 56F
 558290 (MOB) - 1/4 HP, 230/460 VAC, 60 Hz, three-phase, 1,725 rpm, TENV, 56F

Pump Station One is located on the left side, above the sight glass, for all MVB configurations.



MANZEL® LUBE-LINE ALERT

Features and Benefits

- Indicates Flow or No-Flow at any point in the system ahead of the Lube-Line Alert inlet. Not affected by discharge pressure.
- Operates under continuous or intermittent low-flow rates
- Universal use – operates in any air free force feed lubrication system–any make lubricator
- Sensitive to a wide range of flow from .006 cubic inches to 190 cubic inches per minute
- Many type lubricants and viscosities–mineral or synthetic
- Time delay adjustment to compensate for viscosity and/or flow rate. Quick and easy to adjust.
- Explosion-proof – UL and CSA Listed for Class I Groups C and D and Class II Groups E, F and G. Division 1 and 2 when installed as per NEC 501.
- For connection to any electrical warning system–lights, sound devices, machinery shut-off relays, telephones, etc.
- A low-level and shaft rotation

TECHNICAL SPECIFICATIONS

UL and CSA Electrical Ratings	Single pole, Throw magnetically operated switch, 115 VAC, 60Hz, 10 watt, 28 VDC, 0.5 amp Resistive, 28 VDC, 0.5 amp Inductive
Maximum Switch Rating	350 VAC/VDC, 50 watt, 2 amp
Maximum Operating Pressure	10,000 psi
Minimum Pressure Drop Access Alert	150 psi
Flow Rate	0.006 in ³ to 190 in ³ /min @ 100 SUS, 0.006 in ³ to 75 in ³ /min @ 2,000 SUS
Fluid Viscosity	100 to 9,000 SUS
Weight	0.6 lbs



563030

COMPRESSOR LUBRICATION ACCESSORIES

ORDERING OPTIONS

LUBE-LINE ALERT

Part Number	Description
563030	N.C. Configuration with Check Valves for 1/4 in O.D. Tube
563032	N.O. Configuration with Check Valves and Fittings for 1/8 in NPTF Connections

INLET CHECK VALVES

Part Number	Description
563042	With 1/4 in O.D. Tube Fitting (supplied with 563030)
563041	With 7/16-20 Straight Female Thread (supplied with 563032)

OUTLET CHECK VALVES

Part Number	Description
563044	With 1/4 in O.D. Tube Fitting (supplied with 563030)
563043	With 7/16-20 Straight Female Thread (supplied with 563032)

FITTINGS

Part Number	Description
556624	7/16-20 Straight Male Thread x 1/8 in NPTF (2 supplied with 563032)

SPRINGS

Part Number	Description
556944	Standard Springs (installed at factory)
556939	Light Spring for Low Flow Applicator*

REPAIR PARTS

Part Number	Description
556812	Switch Assembly

*When using the Light Spring 556939, fluid viscosity should not exceed 350 SUS.

PNEUMATIC/ELECTRIC LUBE SENTRY VALVE

Features and Benefits

The Lube Sentry Valve provides automatic warning and shutdown of compressors, pumps and engines when oil is not flowing properly to primary dividers in series type lube systems.

- Absence of check valves to avoid trapping contamination from included solids in the lubricant
- Bolted-together components simplifying maintenance. The microswitch assembly on the pneumatic valve can be removed without disturbing existing lines or shutting down the equipment being lubricated.

TECHNICAL SPECIFICATIONS

Material	Steel
Max Pressure	6,000 psi (414 bar)
Flow Rate (per day)	4 to 400 pints (1.89 to 189.2 liters)
Pressure Drop	250 psi (17 bar)
Seals	Fluoroelastomer
Lubricant	Oil (450-2,000 SUS)
Net Weight	0.5 lb (2.265 kg)
Operating Temperature	-20°F to 180°F (-29°C to 82°C)
Air Pressure (Max Pneumatic Valve)	125 psi (9 bar)
Electrical Rating	5 amps @ 125/250 VAC A, B or C @ 28 VDC A - Inductive - 3 amp B - Resistive - 5 amp C - Max Inrush - 15 amp

ORDERING OPTIONS

Part Number	Description
563506	Pneumatic Lube Sentry, Complete
563503	Pneumatic Valve
563502	Actuator
563505	Electric Lube Sentry, Complete
563504	Switch Assembly



563506



BALANCING VALVE

Features and Benefits

The Graco® Balancing Valve assists divider valves to accurately proportion lubricant at high differential pressures. It is recommended for use when a pressure difference greater than 1,000 PSI exists between two or more of the points in a Graco divider valve system.

- Balancing valve is not affected by downstream pressure, assures accurate flow to all lubrication points
- Balancing valve is field adjustable. Reduces on-site inventory costs as one model meets all your system needs.
- Balancing valve is in-line mounted, so it lowers installation costs
- Balancing valve uses a wear-resistant tungsten-carbide ball to reduce maintenance costs



TECHNICAL SPECIFICATIONS

Material	Steel
Max Operating Pressure	6,500 psi
Adjustable	From 1,000 to 6,500 psi (Factory set at 3,000 psi)
Operating Temperature	-10°F to 250°F (-23°C to 121°C)
Lubricant	Oil
Seals	Fluoroelastomer
Net Weight	1.19 lb (0.54 kg)

ORDERING OPTIONS

Part Number	Description
563230	Balancing Valve
563911	Valve Seal Kit



ON-ROAD LUBRICATION

	Page
Electric Grease Jockey®	241-243
Electric Grease Jockey Manifolds	244
Electric Grease Jockey Injectors	245
Electric Grease Jockey Accessories	246-249
Pneumatic Grease Jockey	250-252



ELECTRIC GREASE JOCKEY®

ELECTRIC GREASE JOCKEY

The Grease Jockey system increases fleet utilization. It extends component life up to four times because automatic lubrication continuously flushes contaminants and reduces friction. Auto lube supports 50,000 mile service intervals, optimally lubricates when the vehicle needs it the most, and reduces operating costs. Service more vehicles in less time by utilizing modern automatic lubrication within your fleet.



Ruggedized Construction

U.V., chemical, and high-impact resistant – rigorously tested and field-proven.

NLGI #2 Compatible

NLGI #000 to #2 and 2,000 psi (138 bar).

Low Level Signal

Alerts when out of grease.

Electrical Drive

- 12 VDC (7 Amp) or 24 VDC (4 Amp) power.
- Protected against motor burn-out.

Data Management System*

Track critical lubrication data. Fast programming.

Integrated Controls

Includes adjustable ON/OFF times, PIN code lockout and on-panel alerts.

ON-ROAD LUBRICATION SYSTEMS

TECHNICAL SPECIFICATIONS

Maximum Pressure	2,000 psi (352 bar)
Power	12 VDC, 24 VDC
Operating Temperature	-40° F to 158° F (-40° C to 70° C)
Reservoir Size	2 liter
Maximum Run Time	30 minutes
Output per Element/Min	0.5 in ³ (8 cm ³)
Certifications/Standards	IP69K, CE, ROHS, EMC, Pressurized Equipment Directive, National Fluid Power Association
Instruction Manual	3A5082

In-Cab Feedback*

Tri-color LED system feedback indicator with Manual Run button.

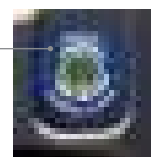

*DMS version optional equipment

ELECTRIC GREASE JOCKEY®

HOW TO SELECT YOUR GRACO ELECTRIC GREASE JOCKEY AUTOMATIC LUBRICATION SYSTEM

Determining the Electric Grease Jockey system best suited to your needs is accomplished by following steps A-D.

ELECTRIC PUMP

A

Choose an Electric Grease Jockey Pump with or without Data Management System (DMS)

Basic Pump:

- #2 grease
- Motor burn-out protection
- Low level feedback
- Power cable

DMS Pump:

- All Standard Pump features, plus DMS:
- Performance data
- In-cab feedback
- Easy load profile option – plug and play programming

Pump Description	Part Number (select one)	
	12 VDC	24 VDC
Electric Grease Jockey	25C990	25C991
Electric Grease Jockey with DMS	25C992	25C993

LUBE POINTS – REAR BRAKES

C

Determine Your System's Rear Brake Lube Points

What is your rear braking system?
Do you have single or tandem axles?

Braking System	Axles	Part Number
Drum brakes	Tandem axle/TAX (8 points)	25C856
	Single axle/SAX (4 points)	25D084*
Disc brakes (0 points)	No kit needed	-

*If lubricating 5th wheel, order package 25C855 from section D instead of package 25D084.

Now that you've selected your pump configuration, it's time to determine the system lube points.

LUBE POINTS – FRONT

B

Determine Your System's Front Lube Points

Front modules all include king pin, tie rod end points, and drag link (left side).
What is your front braking system?
Do you have greaseable or sealed spring pins?

Braking System	Spring Pins	Part Number	
		Left Side	Right Side
Drum brakes (2 points each side)	Spring pins (3 points each side)	25C854 (10 points total)	and 25C859 (8 points total)
	Sealed springs (0 points)	25C858 (7 points total)	and 25C851 (5 points total)
Disc brakes (0 points)	Spring pins (3 points each side)	25C857 (8 points total)	and 25C850 (6 points total)
	Sealed springs (0 points)	25C849 (5 points total)	25C852 (3 points total)

LUBE POINTS – 5TH WHEEL

D

Determine Your System's 5th Wheel Lube Points

What is your 5th wheel configuration?

5th Wheel System	Part Number
5th wheel (6 points)	25C853
5th wheel/SAX drum (10 points)	25C855



The NEW G-Mini® Compact Electric Pump is also suitable for on-road mobile lubrication applications. Refer to pages 13-14 for details.



ORDERING OPTIONS

ELECTRIC GREASE JOCKEY PUMP PACKAGES

	Package Number	25C990	25C991	25C992	25C993
Package Includes	Pump	24Z764	24Z959	24Z660	24Z958
	Power	12V	24V	12V	24V
	Data Management System	-	-	Yes	Yes
	Power Cable	129644	129644	2003896	2003896
	Manual Run Button	-	-	25C981	25C982

ELECTRIC GREASE JOCKEY SYSTEM INSTALLATION KITS

	Package Number	Truck with Greaseable Spring Pins			Truck with Sealed Spring Pins (non-greaseable)		
		Drum Brakes		Disc Brakes	Drum Brakes		Disc Brakes
		6 x 4 Tandem Axle	4 x 2 Single Axle		6 x 4 Tandem Axle	4 x 2 Single Axle	
		32 Point / 4 Module Kit	28 Point / 3 Module Kit	20 Point / 3 Module Kit	26 Point / 4 Module Kit	22 Point / 3 Module Kit	14 Point / 3 Module Kit
Package Includes	12 VDC Grease Jockey pump	25C971	25C972	25C973	25C974	25C975	25C976
	18 ft mainline section/installable end kit	25C990			25C990		
	12 ft mainline section/installable end kit	17S970			17S970		
	6 ft mainline section/installable end kit (qty)	17S969			17S969		
	Mainline tee (qty)	17S968 (2)	17S968 (1)	17S968 (1)	17S968 (2)	17S968 (1)	17S968 (1)
	Mainline tee (qty)	129759 (3)	129759 (2)	129759 (2)	129759 (3)	129759 (2)	129759 (2)
	Mainline elbow (2)	129755			129755		
	Front left meter module	25C854	25C854	25C857	25C858	25C858	25C849
	Front right meter module	25C859	25C859	25C850	25C851	25C851	25C852
	5th wheel meter module	25C853	25C855	25C853	25C853	25C855	25C853
	Rear axle meter module	25C856		-	25C856		-
	3/16 in to 1/8 NPT elbows, 10-Pack (qty)	25C977 (3)	25C977 (3)	25C977 (2)	25C977 (3)	25C977 (2)	25C977
	3/16 in to 1/8 NPT straights, 10-Pack	25C978			25C978		
	1/4-28 SAE to 1/8 NPT (F), 5-Pack	25C979			25C979		
	Mounting bracket	17S107			17S107		
	Zip ties, 100-count	17K063			17K063		
	Zip ties, looped, 10-count (qty)	25C980 (3)	25C980 (2)	25C980 (1)	25C980 (3)	25C980 (2)	25C980 (1)

ON-ROAD LUBRICATION SYSTEMS

ELECTRIC GREASE JOCKEY® MANIFOLDS

CUSTOMIZE AND COMMONIZE YOUR FLEET LUBRICATION

Grease Jockey modular design makes it easy to add or subtract lube points and commonize service parts across your fleet. Modules hold up to 6 or 12 lubrication point meters.

Multiple Mounting and Plumbing Options

Updated for NLGI #2 Grease

Same Pre-Charged, Color Coded Lines and End-Point Fittings







12-Port and 6-Port Options

ORDERING OPTIONS

BUILD YOUR OWN MODULE

Part Number	24Z682	24Z683	24Z684	24Z685	24Z686	24Z681
Grease Jockey Injector Size	#0	#1	#2	#3	#4	#8
Output Spacers	0	1	2	3	4	4
Dispense Amount in ³ (cm ³)	0.002 (0.03)	0.005 (0.08)	0.009 (0.15)	0.012 (0.20)	0.015 (0.25)	0.026 (0.43)
Typical Truck/Trailer Lube Points	S-Cam, Clutch	Slack Adjuster, Pivot Pins	Tie-Rod End, Drag Link	King Pin, Spring Pin	5th Wheel Cylinders	5th Wheel Face Plate

Metering Module Service Items and Accessories

	Part Number	Description
Image Coming Soon	25D012	One replacement #3 meter with pre-charged, 15 ft tube
	25D013	Two replacement #3 meters with pre-charged, 15 ft 2-tube bundle
Image Coming Soon	26C105	Two replacement #4 meters with pre-charged 30 ft 2-tube bundle
	15W165	Feed Line, 3/16 in tube, pre-charged, 30 ft, black
	563789	Feed Line, 3/16 in tube, pre-charged, 15 ft, orange
	564090	Feed Line, 3/16 in 2-tube bundle, pre-charged, 30 ft, orange/black

	Part Number	Description
	563796	Feed Line 3/16 in 3-tube bundle, pre-charged, 30 ft, orange/blue/black
Image Coming Soon	24Z808	Manifold meter port plugs with O-rings
	129752	Manifold inlet plugs
	25C988	Bare manifold with stem, nut and washer, 6 port
	25C989	Bare manifold with stem, nut and washer, 12 port



ELECTRIC GREASE JOCKEY® INJECTORS

INJECTORS DESIGNED FOR FREQUENT MEDIUM-PRESSURE METERING

Designed for frequent metering and includes system pressure monitoring.

Compression Nut With Captured Ferrule Included

For fast, easy connection to 3/16 in OD tubing.



Adjustable Output Volume

Easy to adjust by adding or removing spacers, design also prevents tampering.

Injectors Come In Six Sizes

To meet a wide range of lube requirements.

TYPICAL APPLICATIONS

- On road mobile equipment such as trucks, semi-tractors, semi-trailers, and other vehicles and on-highway equipment.

TYPICAL FLUIDS

- Grease up to NLGI #2

TECHNICAL SPECIFICATIONS

Maximum Operating Pressure	2,000 psi (138 bar)
Minimum Operating Pressure	450 psi (31 bar)
Reset Pressure	250 psi max (17.2 bar)
Maximum Temperature	149°F (65°C)
Cycle Indication	Optional cycle indicator, 563769
Wetted Parts	Aluminum, nitrile rubber (Buna-N), brass, carbon steel, alloy steel
Instruction Manual	312054, 3A5082

ORDERING OPTIONS

Part Number	Size #	Output in ³ (cm ³)	Adjustment Spacers Quantity
24Z682	0	0.002 (0.033)	0
24Z683	1	0.005 (0.082)	1
24Z684	2	0.009 (0.15)	2
24Z685	3	0.012 (0.19)	3
24Z686	4	0.015 (0.25)	4
24Z681	8	0.026 (0.43)	4

ACCESSORIES

Part Number	Description
563769	Injector Cycle Indicator – installs in outlet of each injector, converts outlet to 1/8 in OD tubing
556665	Replacement 1/8 in tube nut for cycle indicator 563769
556660	Replacement 3/16 in tube nut for injector outlets
557901	Injector Outlet Plug – used to disable unneeded injectors without removing from manifold
557898	Output adjustment spacer, brass
556586	Black replacement O-ring for grease injectors
133804	1/8 in NPT outlet adapter for injectors
24Z808	Injector port plugs with O-ring – used to plug unused injector ports

For manifold options, refer to Grease Jockey Accessories sections.





ELECTRIC GREASE JOCKEY® ACCESSORIES

ORDERING OPTIONS



ELECTRIC GREASE JOCKEY PUMP ACCESSORIES

	Part Number	Description
	24Z962	Protective pump cover
Image Coming Soon	25T767	Pump mounting flat bracket with mounting bolts
Image Coming Soon	25T567	Pump mounting offset bracket. For use inside of frame rail; requires 25T767 flat bracket.
Image Coming Soon	557966	Universal "Swiss Cheese" Flat Mounting Adapter
Image Coming Soon	25A170	Fill extension kit
	25C983	Output doubling kit
Image Coming Soon	25C985	Fuse kit, in-line, 12 VDC
Image Coming Soon	25C986	Fuse kit, in-line, 24 VDC

ELECTRIC GREASE JOCKEY PUMP SERVICE ITEMS

	Part Number	Description
	24Z764	12 VDC, 2 L, bare pump with vent valve
	24Z959	24 VDC, 2 L, bare pump with vent valve
	24Z660	DMS, 12 VDC, 2 L, bare pump with vent valve
Image Coming Soon	24Z958	DMS, 24 VDC, 2 L, bare pump with vent valve
Image Coming Soon	25V700	2L G-Mini Jockey, 12V
	25V701	1L G-Mini Jockey, 12V

**ORDERING OPTIONS****ELECTRIC GREASE JOCKEY PUMP SERVICE ITEMS (CONT.)**

	Part Number	Description
Image Coming Soon	129644	Power cable, 30 ft (9.1 m), 2-wire CPC to flying leads
	2003896	DMS power cable, 30 ft (9.1 m), 5-wire CPC to flying leads
Image Coming Soon	17S477	Power cable, 3 ft (1 m), 2-wire CPC to 2-pin automotive connector
	25C981	Manual run button, 12 VDC
	25C982	Manual run button, 24 VDC
Image Coming Soon	25C987	Electric Grease Jockey pump element
Image Coming Soon	25C965	Vent valve assembly, 12 VDC
Image Coming Soon	25C966	Vent valve assembly, 24 VDC
Image Coming Soon	129801	Vent valve power cable
Image Coming Soon	25V702	G-Mini Jockey Timer with Cable
Image Coming Soon	25V703	GLC 2200 Timer Kit
Image Coming Soon	25V704	Pressure Switch Kit
Image Coming Soon	25V705	Injector Bracket Kit

ELECTRIC GREASE JOCKEY® ACCESSORIES

ORDERING OPTIONS

METERING MODULES

· Front Modules all include king pin and tie rod end points.



	Part Number	Description
	25C849	Left Front – 5 points (Drag Link)
	25C850	Right Front – 6 points (Spring Pins)
	25C851	Right Front – 5 points (Drum Brakes)
	25C852	Right Front – 3 points
	25C853	5th Wheel – 6 points (Plate, Pivot pins)
	25C854	Left Front – 10 points (Spring Pins, Drum Brakes, Drag Link)
	25C855	5th Wheel – 10 points (Single Axle Drum Brakes, Plate, Pivot pins)
	25C856	Tandem axle – 8 points (Drum Brakes)
	25C857	Left front – 8 points (Spring Pins, Drag Link)
	25C858	Left front – 7 points (Drum Brakes, Drag Link)
	25C859	Right Front – 8 points (Spring Pins, Drum Brakes)
	25D084	Single axle – 4 points (Drum Brakes)
	26C081	TAX/5th Wheel – 14 point (Drum Brakes, Plate, Pivot pins) Double Module
	26C101	Drop Axle, 8 Point (King Pins, drum brakes)
	26C100	Drop Axle, 10 Point (King Pins, Tie-rod ends, drum brakes)
	26C104	Dump Body, 10 Point
25D216	6 point (#3) meter module, pre-charged lines	
25D217	12 point (#3) meter module, pre-charged lines	

Notes: **Meter modules do not include end-point fittings.** Customized meter modules available upon request, minimum order 50 units.

LUBRICANT

	Part Number	Description
	557941	NLGI #00 grease, 35 lb bucket







GREASE JOCKEY FILL PUMP KITS

	Part Number	Description
	26A320	Mini Fire-Ball 400 lb fill pump kit
	247886	Manual 35 lb fill pump kit
	121474	Coupler, hydraulic quick disconnect, 1/4 in NPT



ORDERING OPTIONS

END-POINT FITTINGS (not included with injector manifolds) AND INSTALLATION ACCESSORIES

	Part Number	Description
	25C977	10 pack of P/N 556638, 3/16 in OD tube to 1/8 NPT elbows
	26A405	200 pack of P/N 556638, 3/16 in OD tube to 1/8 NPT elbows
	25C978	10 pack of P/N 556644, 3/16 in OD tube to 1/8 NPT straight connectors
	26A404	200 pack of P/N 556644, 3/16 in OD tube to 1/8 NPT straight connectors
	25C979	5 pack of P/N 15K784, 1/4-28 SAE (m) to 1/8 NPT(F) elbow, 90°
	26A406	100 pack of P/N 15K784, 1/4-28 SAE (m) to 1/8 NPT(F) elbow, 90°
	556660	3/16 in tube nut sleeve with captivated ferrule
	15K783	1/8 NPT(M) to 1/8 NPT(F) elbow, 90°
	557395	1/8 NPT(M) to 1/8 NPT(F) elbow, 45°
	557392	0.75 in extension, 1/8 NPT(M) to 1/8 NPT(F)
	557393	1.25 in extension, 1/8 NPT(M) to 1/8 NPT(F)
Image Coming Soon	25M544	6 ft conduit sleeve
	17K063	Cable ties, 100 pack
	25C980	Figure-8 cable ties, 10 pack
Image Coming Soon	26C326	Mainline purge adapter, JIC-6 x 1/4 in QD male

PNEUMATIC GREASE JOCKEY®

KEEP YOUR CHASSIS OPERATING, EVEN IN HARSH ON-ROAD CONDITIONS

Lubricant goes where it's supposed to, automatically, with little or no waste. Field-proven – some of the largest fleets have been using Grease Jockey for decades.

ON-ROAD LUBRICATION SYSTEMS



High-Strength, Shatter-Resistant Reservoir

Utilizes a high-quality, polycarbonate reservoir that is securely mounted to the pump with rigid tie rods for optimal sealing.

Field-Proven Reliability

Over four decades of over-the-road experience.

High-Capacity Fill Port

Saves time and keeps you on the road.

Rugged Cast Aluminum Construction

9:1 pump with 6 lb capacity.



Digital Control Timer

PIN code lockout keeps your air-powered lubrication system profile safe.

TECHNICAL SPECIFICATIONS

Construction	Cast aluminum body and bracket
Lubricant	NLGI #0, #00 or #000 grease
Output per Cycle	1.5 in ³ (24.6 cm ³)
Reservoir Capacity	6 lb (2.7 kg), 12 lb (5.4 kg)
Inlet Supply (dry) (air pump)	150 psi (1034 kPa) max; 60 psi (414 kPa) min
Air-to-Lube Ratio (maximum)	9:1
Solenoid Voltage (air)	12 or 24 VDC
Electrical	9 to 32 VDC (12 or 24 VDC Nominal)
Enclosure (air pump)	High-impact sealed plastic
Component Technology	Solid-state
Pump "ON" Time	Programmable: 1 second to 99 minutes
Lube Cycle Frequency	Programmable: 1 minute to 99 hours
Main Supply to Modules	5/16 in O.D. heavywall nylon
Module to Point	3/16 in O.D. heavywall nylon
Operating Pressure (nylon lines)	1,350 psi (9,310 kPa)
Instruction Manual	312054



ORDERING OPTIONS



PNEUMATIC GREASE JOCKEY PUMPS

	Package Number	563625	563589	563590	563593	563888	563854	563874
Package Includes	Reservoir Size	Pump only	6 lb	12 lb	6 lb	6 lb	6 lb	12 lb
	Fill Port	Straight	Straight	Straight	Elbow	Elbow	Straight	Straight
	Solenoid	-	-	-	-	12 VDC	12 VDC	12 VDC
	Timer/Wiring Harness Kit	-	-	-	-	-	25A118	25A118
	Mounting Plate	-	-	-	-	-	Yes	Yes
	Mainline and Hardware	-	-	-	-	-	Yes	Yes
	Extra Fittings Kit	-	-	-	-	-	Yes	Yes

PNEUMATIC GREASE JOCKEY SYSTEM INSTALLATION KITS

	Package Number	Truck with Greaseable Spring Pins			Truck with Sealed Spring Pins (non-greaseable)			
		Drum Brakes		Disc Brakes	Drum Brakes		Disc Brakes	
		6 x 4 Tandem Axle	4 x 2 Single Axle		6 x 4 Tandem Axle	4 x 2 Single Axle		
		34 Point / 4 Module Kit	28 Point / 3 Module Kit	20 Point / 3 Module Kit	26 Point / 4 Module Kit	22 Point / 3 Module Kit	14 Point / 3 Module Kit	
Package Includes	12 VDC Grease Jockey Pump and Reservoir	563589 / 563854	24Z526	24Z526	24Z526	24Z526	24Z526	
	Front Left Meter Module	563644	24W623	563654	563706	563706	563728	
	Front Right Meter Module	563645	563858	563655	24W335	24W335	24H994	
	5th Wheel Meter Module	563648	258348	563648	563648	258348	563648	
	Rear Axle Meter Module	563646		-	563646		-	
	Mounting Bracket	128256	128256	128256	128256	128256	128256	
	Control Timer		25A118			25A118		

ACCESSORIES

	Part Number	Description
	128256	Mounting bracket
	24W482	Digital control timer for air-powered systems

PNEUMATIC GREASE JOCKEY®

HOW TO SELECT YOUR GRACO PNEUMATIC GREASE JOCKEY AUTOMATIC LUBRICATION SYSTEM

Determining the Pneumatic Grease Jockey system best suited to your needs is accomplished by using the following steps.

A

PUMP

Pneumatic Grease Jockey Pump

Pump Description	Part Number
Pneumatic Grease Jockey 9:1 ratio, 6 lb reservoir, 12 VDC, controller, solenoid, mainline, and mounting hardware	563854

Now that you've selected your pump configuration, it's time to determine the system lube points.

B

LUBE POINTS - FRONT LEFT

Determine Your System's Front Left Lube Points

What is your front braking system?
Do you have greaseable or sealed spring pins?

Braking System	Spring Pins	Part Number
Drum brakes (2 points)	Spring lube (3 points)	563644 (10 points total)
	Sealed springs (0 points)	563706 (7 points total)
Disc brakes (0 points)	Spring lube (3 points)	563654 (8 points total)
	Sealed springs (0 points)	563728 (5 points total)

D

LUBE POINTS - REAR BRAKES

Determine Your System's Rear Brake Lube Points

What is your rear braking system?
Do you have single or tandem axles?

Braking System	Axles	Part Number
Drum brakes	Tandem axle/TAX (8 points)	563646
	Single axle/SAX (4 points)	563647*
Disc brakes (0 points)	No kit needed	-

*If lubricating 5th wheel, order package 258348 from Section E instead of package 563647.

E

LUBE POINTS - 5TH WHEEL

Determine Your System's 5th Wheel Lube Points

What is your 5th wheel configuration?

5th Wheel System	Part Number
5th wheel (6 points)	563648
5th wheel/SAX drum (10 points)	258348

C

LUBE POINTS - FRONT RIGHT / TRANSMISSION

Determine Your System's Front Right / Transmission Lube Points

Does your transmission have lube points? What is your front braking system?
Do you have greaseable or sealed spring pins?

Clutch Points	Braking System	Spring Pins	Part Number
2 clutch points	Drum brakes (2 points)	Spring lube (3 points)	563645 (10 pts total)
		Sealed springs (0 points)	563859 (7 pts total)
	Disc brakes (0 points)	Spring lube (3 points)	24X743 (8 pts total)
		Sealed springs (0 points)	563727 (5 pts total)
No clutch points	Drum brakes (2 points)	Spring lube (3 points)	563858 (8 pts total)
		Sealed springs (0 points)	563860 (5 pts total)
	Disc brakes (0 points)	Spring lube (3 points)	563655 (6 pts total)
		Sealed springs (0 points)	24H994 (3 pts total)

ADDITIONAL SYSTEM PRODUCTS

ADDITIONAL SYSTEM PRODUCTS

Additional Grease Jockey System Products

Product Description	Part Number
Steering assist lube points for front right	563862 (2 points)
Steerable drop axle lube points	564194 (10 points)
Non-steerable drop axle lube points	563856 (6 points)
Dump body kit	563857 (6 points)



GRACO EQUIPMENT WARRANTY

STANDARD GRACO WARRANTY

1-YEAR WARRANTY POLICY

Graco warrants all equipment manufactured by Graco and bearing its name to be free from defects in material and workmanship on the date of sale by an authorized Graco distributor to the original purchaser for use. With the exception of any special, extended, or limited warranty published by Graco, Graco will, for a period of twelve (12) months from the date of sale, repair or replace any part of the equipment determined by Graco to be defective.

This warranty applies only when the equipment is installed, operated and maintained in accordance with Graco's written recommendations. This warranty does not cover, and Graco shall not be liable for general wear and tear, or any malfunction, damage or wear caused by faulty installation, misapplication, abrasion, corrosion, inadequate or improper maintenance, negligence, accident, tampering, or substitution of non-Graco component parts. Nor shall Graco be liable for malfunction, damage or wear caused

by the incompatibility of Graco equipment with structures, accessories, equipment or materials not supplied by Graco, or the improper design, manufacture, installation, operation or maintenance of structures, accessories, equipment or materials not supplied by Graco.

This warranty is conditioned upon the prepaid return of the equipment claimed to be defective to an authorized Graco distributor for verification of the claimed defect. If the claimed defect is verified, Graco will repair or replace free of charge any defective parts. The equipment will be returned to the original purchaser transportation prepaid. If inspection of the equipment does not disclose any defect in material or workmanship, repairs will be made at a reasonable charge, which charges may include the costs of parts, labor, and transportation.

THIS WARRANTY IS EXCLUSIVE, AND IS IN LIEU OF ANY OTHER WARRANTIES, EXPRESS OR IMPLIED, INCLUDING BUT NOT LIMITED TO WARRANTY OF MERCHANTABILITY OR WARRANTY OF FITNESS FOR A PARTICULAR PURPOSE.

Graco's sole obligation and buyer's sole remedy for any breach of warranty shall be as set forth above. The buyer agrees that no other remedy (including, but not limited to, incidental or consequential damages for lost profits, lost sales, injury to person or property, or any other incidental or consequential loss) shall be available. Any action for breach of warranty must be brought within two (2) years of the date of sale.

Graco makes no warranty, and disclaims all implied warranties of merchantability and fitness for a particular purpose in connection with accessories, equipment, materials or components sold but not manufactured by Graco. These items sold, but not manufactured, by Graco (such as electric motors, switches, hose, etc.) are subject to the warranty, if any, of their manufacturer. Graco will provide purchaser with reasonable assistance in making any claim for breach of these warranties.

In no event will Graco be liable for indirect, incidental, special or consequential damages resulting from Graco supplying equipment hereunder, or the furnishing, performance, or use of any products or other goods sold hereto, whether due to a breach of contract, breach of warranty, the negligence of Graco, or otherwise.

GRACO AUTOMATIC LUBRICATION EQUIPMENT EXTENDED WARRANTY

This warranty does not cover, and Graco shall not be liable for, general wear and tear, or any malfunction, damage or wear caused by faulty installation, misapplication, abrasion, corrosion, inadequate or improper maintenance, negligence, accident, tampering, or substitution of non-Graco component parts. Nor shall Graco be liable for malfunction, damage or wear caused by the incompatibility of Graco equipment with structures, accessories, equipment or materials not supplied by Graco, or the improper design, manufacture, installation, operation or maintenance of structures, accessories, equipment or materials not supplied by Graco.

This warranty is conditioned upon the prepaid return of the equipment claimed to be defective to an authorized Graco distributor for verification of the claimed defect. If the claimed defect is verified, Graco will repair or replace free of charge any defective parts. The equipment will be returned to the original purchaser transportation prepaid. If inspection of the equipment does not disclose any defect in material or workmanship, repairs will be made at a reasonable charge, which charges may include the costs of parts, labor, and transportation.

THIS WARRANTY IS EXCLUSIVE, AND IS IN LIEU OF ANY OTHER WARRANTIES, EXPRESS OR IMPLIED, INCLUDING BUT NOT LIMITED TO WARRANTY OF MERCHANTABILITY OR WARRANTY OF FITNESS FOR A PARTICULAR PURPOSE.

Graco's sole obligation and buyer's sole remedy for any breach of warranty shall be as set forth above. The buyer agrees that no other remedy (including, but not limited to, incidental or consequential damages for lost profits, lost sales, injury to person or property, or any other incidental or consequential loss) shall be available. Any action for breach of warranty must be brought within one (1) year post the warranty period.

GRACO MAKES NO WARRANTY, AND DISCLAIMS ALL IMPLIED WARRANTIES OF MERCHANTABILITY AND FITNESS FOR A PARTICULAR PURPOSE, IN CONNECTION WITH ANY ACCESSORIES, EQUIPMENT, MATERIALS OR COMPONENTS SOLD BUT NOT MANUFACTURED BY GRACO.

These items sold, but not manufactured, by Graco (such as electric motors, switches, etc.) are subject to the warranty, if any, of their manufacturer. Graco will provide purchaser with reasonable assistance in making any claim for breach of these warranties.

In no event will Graco be liable for indirect, incidental, special or consequential damages resulting from Graco supplying equipment hereunder, or the furnishing, performance, or use of any products or other goods sold hereto, whether due to a breach of contract, breach of warranty, the negligence of Graco, or otherwise.

FOR GRACO CANADA CUSTOMERS

The parties acknowledge that they have required that the present document, as well as all documents, notices and legal proceedings entered into, given or instituted pursuant hereto or relating directly or indirectly hereto, be drawn up in English.

Les parties reconnaissent avoir convenu que la rédaction du présente document sera en Anglais, ainsi que tous documents, avis et procédures judiciaires exécutés, donnés ou intentés à la suite de ou en rapport, directement ou indirectement, avec les procédures concernées.



Graco warrants all equipment referenced in this document that is manufactured by Graco and bearing its name to be free from defects in material and workmanship on the date of sale to the distributor. Graco will, for a period as defined in the table below from the date of sale, repair or replace equipment

covered by this warranty and determined by Graco to be defective. This warranty applies only when the equipment is installed, operated, and maintained in accordance with Graco's written recommendations.

Products	Warranty Period
Oil King, Coolant King and Oil Ace	5 Years
Pulse Fluid Management HUBs, TLMs, PACs and Extenders	2 Years
Pulse Level	2 Years
GCI and GL-1 X Injectors	2 years
Electric Grease Jockey	5 Years
Cord and Light Reels	2 Years
Electrical Components	1 Year
LDX Series Hose Reels	5 Years
Wear Parts, including but not limited to hose, seals, swivel seats and roller guides	1 Year
SDX Series Hose Reels	7 Years
Power Springs	3 Years
Wear Parts, including but not limited to hose, seals, swivel seats and roller guides	1 Year
XD and XDX Series Hose Reels	7 Years
Power Springs	3 Years
Wear Parts, including but not limited to hose, seals, swivel seats, roller guides and motors	1 Year
Mechanical Meters	5 years
Wear parts, including but not limited to O-rings, seals and valves	1 Year
LD Preset Meters	5 years
Electronics	2 Years
Wear parts, including but not limited to O-rings, seals and valves	1 Year
EM, Pulse and SD Meters	5 Years
Electronics	3 Years
Wear parts, including but not limited to O-rings, seals and valves	1 Year
LD Oil/Grease Pumps	5 Years
Wear Parts, including but not limited to O-rings, packings and seals	1 Year
Hoses with pump packages	1 Year
AODD Pumps	5 Years
Wear Parts, including but not limited to O-rings, packings and seals	1 Year
Hoses with pump packages	1 Year
Mini Fire-Ball 225 and Fire-Ball 300 Oil and Grease Pumps	7 Years
Wear Parts, including but not limited to O-rings, packings and seals	1 Year
Hoses with pump packages	1 Year
Fire-Ball 425 Oil and Grease Pumps	10 Years
Wear Parts, including but not limited to O-rings, packings and seals	1 Year
Hoses with pump packages	1 Year
Fast-Ball and FastBall-100	5 Years
LD Blue and SD Blue Diesel Exhaust Fluid Pumps	2 Years

WARRANTY

INDEX

PART NO.	PAGE NO.	PART NO.	PAGE NO.	PART NO.	PAGE NO.
15D936	190	17J939	28, 104	17R575	212
15E279	195	17K061	181, 184	17R576	212
15H304	186	17K062	184	17R577	212
15K783	181, 219, 249	17K063	111, 210, 243, 249	17R578	212
15K784	181, 249	17K601	125	17R703	14, 128
15M037	210	17K602	125	17S107	243
15M045	181	17K603	125	17S392	125
15M442	84, 85	17K604	125	17S393	125
15M805	195	17K615	191	17S394	125
15M861	196	17L366	55, 178	17S395	125
15M863	199	17L372	85	17S396	125
15R130	78	17L437	215	17S477	247
15R993	157	17L438	215	17S552	211
15R994	157	17L440	222	17S553	211
15U857	163	17L441	128, 215	17S554	211
15W165	219, 244	17L442	215	17S555	211
15X886	196	17L446	218	17S556	217
15X983	197	17L447	218	17S557	217
15Y070	143	17L448	218	17S558	217
15Y925	190	17L449	213	17S559	217
15Y934	190	17L455	218	17S968	243
16A169	219	17L456	218	17S969	243
16A171	167, 220	17L457	218	17S970	243
16A172	220	17L458	128, 213	17T211	200
16A361	200	17L543	218	17T246	185
16A362	200	17L545	213	17T780	212
16C398	199	17L546	212	17T781	212
16C399	199	17L547	215	17T782	212
16C475	196	17L548	212	17T783	212, 218
16C637	196	17L550	128, 212	17U217	64
16D939	182	17L647	215	17U308	192
16F255	182	17L648	211, 212	17U319	192
16F259	185	17L649	212, 213	17U325	191
16H491	196	17L650	212	17U385	191
16J975	196	17L651	128	17V389	193
16P292	183	17L652	222	17V721	218
16P368	143	17L653	222	17V731	191
16R882	195	17L680	213	17Y235	193
16R883	195	17L692	222	17Y236	193
16T315	184	17L706	208	17Y489	125
16T671	106, 108	17L754	125	17Y498	125
16U217	138, 151, 159	17L755	125	17Y510	125
16U790	14, 30, 140	17L875	191	17Y511	125, 126
16U878	190	17L879	14, 28, 128, 165	17Y689	213
16U879	190	17L880	154, 160, 165	17Y690	213
16V432	189	17L881	164, 165	17Y691	213
16V434	192	17L898	191	17Y692	128
16V678	55	17L899	191	17Y693	128
16V999	24	17L941	215	18B302	183
16W608	191	17L942	216	18C751	66
16W609	192	17L983	28, 139, 146, 165	18C752	66
16W610	192	17M380	129, 132, 165	19A574	146
16W611	193	17N453	125	19B227	145
16Y235	182	17N454	125	19B332	192
17B168	120	17N455	125	20A081	140
17B169	120	17N456	125	20A339	140
17B780	120	17N457	125	20A585	140
17B781	120	17N458	125	20A586	140
17B782	120	17P336	217	20A900	140
17B783	120	17P337	217	20A901	140
17B785	120	17P339	110	20A902	140
17B879	120	17P340	111	20A903	140
17B880	120	17P751	64	20A904	140
17C751	66	17P753	64	24A918	126
17C752	66	17R565	211	24A919	118
17D023	209	17R566	211	24A920	118
17D024	209	17R567	218	24A921	118
17D688	110	17R568	218	24A922	118
17G007	103, 106	17R569	213	24A923	118
17G388	182	17R570	213	24A924	118
17G422	184	17R571	212	24B237	167
17G704	191	17R572	212, 218	24B239	167
17G711	182	17R573	212	24B240	167
17J423	139, 209	17R574	212	24B241	167

INDEX

PART NO.	PAGE NO.	PART NO.	PAGE NO.	PART NO.	PAGE NO.
24B359.....	126	24J398.....	232	24W483.....	119
24B360.....	118	24J399.....	232	24W484.....	119
24B474.....	144	24J814.....	167	24W485.....	119
24B475.....	144	24J815.....	167	24W486.....	119
24B476.....	144	24J816.....	167	24W487.....	119
24B477.....	144	24J817.....	167	24W488.....	119
24B478.....	144	24K414.....	28, 207	24W489.....	119
24B479.....	144	24K415.....	170	24W490.....	119
24B480.....	144	24k466.....	232	24W491.....	119
24B481.....	144	24K466.....	61, 227, 230	24W492.....	119
24B482.....	144	24M478.....	30	24W493.....	119
24B483.....	144	24M479.....	30	24W494.....	119
24B495.....	145	24M480.....	30	24W495.....	120
24B496.....	145	24M481.....	30	24W501.....	119
24B497.....	143	24M482.....	30	24W502.....	119
24B498.....	143	24M483.....	30	24W503.....	119
24B591.....	104	24M484.....	30	24W504.....	119
24B596.....	104	24M644.....	14, 26, 209	24W505.....	119
24B677.....	120	24N181.....	55, 80, 85, 207	24W506.....	119
24E240.....	118	24N182.....	30	24W507.....	119
24E241.....	118	24N351.....	30, 71	24W601.....	119
24E242.....	118	24N369.....	143	24W602.....	119
24E243.....	118	24N373.....	145	24W603.....	119
24E244.....	118	24N382.....	142	24W604.....	119
24E245.....	118	24N383.....	142	24W605.....	119
24E389.....	118	24N384.....	142	24W606.....	119
24E390.....	118	24N385.....	142	24W607.....	119
24E391.....	118	24N386.....	142	24W623.....	251
24E392.....	118	24N388.....	142	24W633.....	94, 231
24E393.....	118	24N389.....	142	24W634.....	94, 231
24E394.....	118	24N390.....	142	24W635.....	94, 231
24E691.....	208	24N391.....	142	24W636.....	94, 231
24F201.....	118	24N392.....	142	24W701.....	119
24F508.....	118	24N402.....	30	24W702.....	119
24F509.....	118	24N468.....	106	24W703.....	119
24F510.....	118	24N724.....	94, 231	24W704.....	119
24F511.....	118	24N915.....	135	24W705.....	119
24F512.....	118	24N916.....	135	24W706.....	119
24F513.....	120	24N917.....	135	24W707.....	119
24F514.....	120	24N918.....	135	24W801.....	119
24F543.....	118	24N919.....	135	24W802.....	119
24F544.....	118	24N920.....	135	24W803.....	119
24F545.....	118	24N945.....	145	24W804.....	119
24F546.....	118	24N948.....	145	24W805.....	119
24F548.....	118	24N949.....	145	24W806.....	119
24F550.....	118	24N951.....	145	24W807.....	119
24F551.....	118	24N952.....	145	24W808.....	119
24F552.....	118	24P295.....	23	24W865.....	197
24F553.....	118	24P296.....	23	24W901.....	119
24F554.....	118	24P314.....	106	24W902.....	119
24F555.....	120	24P548.....	193	24W903.....	119
24F556.....	120	24P686.....	106, 108	24W904.....	119
24F596.....	148	24P687.....	106, 108	24W905.....	119
24F597.....	148	24P731.....	29	24W906.....	119
24F598.....	148	24P976.....	170	24W907.....	119
24F599.....	148	24R631.....	144	24W913.....	119
24F600.....	148	24R632.....	144	24W914.....	119
24F601.....	148	24R633.....	144	24W915.....	119
24F943.....	120	24R873.....	119	24W981.....	106
24F944.....	118	24R952.....	55	24X027.....	150
24G485.....	135	24T296.....	170	24X028.....	150
24G486.....	135	24T306.....	232	24X029.....	150
24G487.....	135	24U750.....	94, 231	24X030.....	150
24G488.....	135	24V068.....	94, 231	24X302.....	119
24G489.....	135	24W335.....	251	24X303.....	119
24G490.....	135	24W401.....	119	24X304.....	119
24H994.....	251, 252	24W402.....	119	24X305.....	119
24J391.....	227, 232	24W403.....	119	24X306.....	119
24J392.....	227, 232	24W404.....	119	24X307.....	119
24J393.....	227, 232	24W405.....	119	24X401.....	124
24J394.....	232	24W406.....	119	24X402.....	124
24J395.....	232	24W407.....	119	24X403.....	124
24J396.....	232	24W408.....	119	24X405.....	124
24J397.....	232	24W482.....	108, 251	24X606.....	106, 108

INDEX

PART NO.	PAGE NO.	PART NO.	PAGE NO.	PART NO.	PAGE NO.
24X743	252	25A080	125	25R800	14
24X807	124	25A081	125	25R801	14
24Y407	84	25A118	108, 251	25R802	14
24Y498	66	25A170	246	25R803	14
24Z021	65	25A189	86	25R804	14
24Z022	65	25B514	140	25R807	14
24Z026	65	25B515	140	25R820	14
24Z027	65	25B534	140	25R821	14
24Z028	65	25B535	140	25R824	14
24Z052	65	25C764	23	25R831	14
24Z053	65	25C771	108	25R832	14
24Z057	65	25C849	242, 243, 248	25R833	14
24Z058	65	25C850	242, 243, 248	25R834	14
24Z059	65	25C851	242, 243, 248	25R835	14
24Z477	127	25C852	242, 243, 248	25R837	14
24Z478	127	25C853	242, 243, 248	25T567	246
24Z479	127	25C854	242, 243, 248	25T585	140
24Z480	127	25C855	242, 243, 248	25T641	124
24Z481	127	25C856	242, 243, 248	25T642	124
24Z482	127	25C857	242, 243, 248	25T643	124
24Z483	127	25C858	242, 243, 248	25T644	124
24Z484	127	25C859	242, 243, 248	25T645	124
24Z485	127	25C950	85	25T646	124
24Z486	15, 127	25C951	85	25T649	124
24Z487	15, 127	25C965	247	25T767	246
24Z488	15, 127	25C966	247	25T775	118
24Z489	15, 127	25C971	243	25T847	223
24Z490	15, 127	25C972	243	25T989	58, 93
24Z491	15, 127	25C973	243	25U040	140
24Z492	127	25C974	243	25U041	140
24Z493	127	25C975	243	25U051	140
24Z494	127	25C976	243	25U052	140
24Z495	127	25C977	243, 249	25U053	140
24Z496	127	25C978	243, 249	25U054	140
24Z497	127	25C979	243, 249	25U200	56
24Z498	127	25C980	243, 249	25U202	56
24Z499	127	25C981	14, 19, 25, 243, 247	25U234	165
24Z500	127	25C982	14, 19, 25, 243, 247	25U285	207
24Z501	127	25C983	246	25U286	207
24Z502	127	25C985	110, 246	25U706	24, 208
24Z503	127	25C986	110, 246	25V700	246
24Z504	127	25C987	32, 247	25V701	246
24Z505	127	25C988	244	25V702	247
24Z506	127	25C989	244	25V703	247
24Z507	127	25C990	242, 243	25V704	247
24Z508	127	25C991	242, 243	25V705	247
24Z509	127	25C992	242, 243	26A320	26, 248
24Z510	127	25C993	242, 243	26A404	249
24Z511	127	25D012	244	26A405	249
24Z512	127	25D013	244	26A406	249
24Z526	251	25D084	242, 248	26A478	128
24Z660	243, 246	25D096	80	26A479	128
24Z675	157	25D216	248	26A782	165
24Z681	244, 245	25D217	248	26A814	51, 103
24Z682	244, 245	25D336	125	26A853	51, 103
24Z683	244, 245	25E349	125	26A855	51, 103
24Z684	244, 245	25E935	128	26A882	51, 103
24Z685	244, 245	25M496	215	26A883	51, 103
24Z686	244, 245	25M497	215	26A884	51, 110
24Z714	165	25M544	249	26A888	51, 103
24Z715	165	25M602	28, 165	26A889	51, 110
24Z719	165	25M603	28, 165	26A910	14, 24
24Z720	165	25M604	165	26C030	24
24Z764	243, 246	25N013	217	26C081	248
24Z808	244, 245	25N101	124	26C100	248
24Z809	251	25N104	124	26C101	248
24Z810	251	25N106	124	26C104	248
24Z811	251	25N109	124	26C105	244
24Z812	251	25N624	92	26C176	24
24Z813	251	25N730	128	26C326	249
24Z958	243, 246	25R001	51	26C344	47
24Z959	243, 246	25R318	51	26C537	84
24Z962	25, 41, 246	25R513	94, 231	26C538	84
25A071	94, 231	25R557	94, 231	26C539	84

INDEX

PART NO.	PAGE NO.	PART NO.	PAGE NO.	PART NO.	PAGE NO.
26C822	128	96G056	18	96G414	32
26C823	128	96G057	18	96G415	32
26C825	14	96G058	18	96G416	32
26C826	14	96G059	18	96G417	32
26C947	14	96G060	18	96G543	19
26C980	111	96G061	18	96G544	19
77X000	53	96G062	18	96G545	20
77X001	53	96G068	18	96G546	20
77X002	53	96G069	18	96G547	19
77X003	53	96G070	18	96G548	19
77X011	54	96G071	18	96G549	20
77X012	54	96G072	18	96G550	20
77X013	54	96G073	18	96G551	19
77X014	53	96G075	18	96G552	19
77X015	53	96G076	18	96G553	20
77X016	53	96G077	18	96G554	20
77X100	53	96G078	18	96G555	19
77X202	53	96G079	18	96G556	19
77X500	54	96G080	18	96G557	20
77X510	54	96G081	18	96G558	20
77X513	54	96G082	18	96G560	19
77X514	54	96G135	18	96G562	20
77X521	54	96G136	18	96G564	19
77X522	54, 80, 85	96G137	18	96G565	20
77X523	54, 178	96G138	18	96G566	20
77X524	52, 55	96G139	18	96G568	19
77X540	55	96G140	18	96G569	20
77X541	54, 178	96G147	18	96G570	20
77X542	22, 26, 55	96G148	18	96G572	19
77X543	55	96G149	18	96G573	20
77X544	55	96G150	18	96G574	20
77X545	55	96G163	18	96G580	19
77X546	55	96G167	18	96G581	20
94G411	32	96G171	18	96G582	20
95G102	38	96G172	18	96G591	20
95G103	38	96G182	18	96G592	20
95G104	39	96G184	18	96G593	20
95G108	39	96G189	18	96G594	20
95G109	38	96G192	18	96G595	20
95G110	39	96G194	18	96G596	20
95G111	39	96G196	18	96G599	20
95G112	38	96G198	18	96G600	20
96G000	18	96G199	18	96G601	20
96G001	18	96G202	18	96G602	20
96G002	18	96G204	18	96G603	20
96G003	18	96G205	18	96G604	20
96G005	18	96G207	18, 22	96G605	20
96G006	18	96G208	22	96G606	20
96G007	18	96G209	22	96G607	20
96G008	18	96G210	18, 22	96G608	20
96G011	18	96G213	18, 22	96G609	20
96G012	18	96G214	22	96G610	20
96G013	18	96G215	22	96G611	20
96G014	18	96G217	18, 22	96G612	20
96G027	18	96G220	18	96G613	20
96G028	18	96G238	18	96G614	20
96G029	18	96G239	18	96G615	20
96G033	18	96G240	18	96G616	20
96G034	18	96G241	18	96G617	32
96G038	18	96G243	18	96G619	32
96G039	18	96G258	18	96G627	32
96G040	18	96G278	33, 34	96G629	32
96G041	18	96G279	33, 34	96G634	20
96G042	18	96G291	18	96G635	32
96G043	18	96G320	18	96G636	32
96G044	18	96G321	18	96G637	32
96G045	18	96G322	18	100030	183
96G048	18	96G331	18	100040	186
96G049	18	96G332	18	100054	210
96G050	18	96G400	32	100081	183
96G051	18	96G407	32	100206	183
96G052	18	96G410	32	100361	186
96G053	18	96G412	32	100380	183
96G055	18	96G413	32	100451	183

INDEX

PART NO.	PAGE NO.	PART NO.	PAGE NO.	PART NO.	PAGE NO.
100474	183	115122	24, 80	122717	191
100483	184	115124	55, 80, 85, 207	122718	191
100505	183	115523	25, 208	122719	191
100509	186	115764	181	122720	189
100615	183	116383	208	122721	191
100721	186	116400	196	122722	189
100737	186	116648	187	122727	199
100839	181	116650	183	122737	199
100840	181	116702	189	122763	195
100848	210	116703	189	122767	196
100854	209	116704	189	122786	198
100896	183	116712	199	122841	117
100960	208	116745	187	122844	196
101689	208	116755	181	122861	117
101754	186	116756	181	122862	117
101909	189	116765	189	122866	117
101970	196	116766	190	122868	117
102258	111	117206	124	122869	117
104099	192	117455	189	122888	117
104663	186	117502	191	122889	117
104911	111	117506	191	122961	199
104984	184	117556	193	122963	191
105281	188	117557	193	122967	191
105474	67, 167	117634	191	122968	192
106595	111	117635	191	122970	189
107128	185	117677	191	122991	199
108673	196	117832	189, 217	122992	189
109025	111	117833	189	123024	196
109075	80	118137	181	123094	192
110150	80	118206	124	123106	198
110191	196	118758	183	123107	198
110319	208	118896	192	123108	198
110336	195	119783	188	123135	190
110792	192	119789	181	123136	199
111643	195	119900	195	123140	193
111697	186	119998	189	123147	211
111856	181	120064	192	123251	189
112026	195	120112	193	123358	30
112100	199	120170	193	123379	182
112307	181	120185	189	123417	199
112564	208	120804	192	123514	196
112567	208	121041	198	123528	193
113093	183	121042	198	123553	198
113344	187	121043	198	123596	199
113445	181	121044	198	123597	199
113548	184	121163	185	123598	199
113641	208	121283	181	123599	199
113654	208	121310	189	123683	189
113786	184	121311	189	123684	189
113933	195	121312	192	123787	193
114030	188	121319	189	123788	193
114172	144, 196	121321	192	123854	190
114247	198	121474	14, 26, 67, 209, 248	123888	181
114337	189	121486	192	123889	181
114373	195	121658	117	123896	190
114446	197	121659	117	123897	190
114484	198	121660	117	123980	197
114488	80	121661	117	124089	178
114504	195	121665	117	124090	178
114506	195	121668	117	124113	178
114874	197	121907	195	124152	198
114901	124	121908	197	124221	199
114902	124	122276	129, 136, 143, 149	124286	189
114903	124	122311	192	124287	189
114904	124	122327	181	124288	190
114905	124	122398	191	124300	28, 29, 104, 165
114909	124	122400	191	124301	29
114911	124	122401	193	124315	199
114912	124	122406	189	124333	14, 29, 165, 207
114913	124	122520	192	124342	110, 111
114914	124	122533	193	124343	110, 111
114915	124	122656	196	124403	189
114916	122	122711	192	124405	191
115010	157	122715	198	124406	190

INDEX

PART NO.	PAGE NO.	PART NO.	PAGE NO.	PART NO.	PAGE NO.
124408.....	193	127123.....	29	131164.....	216
124433.....	199	127128.....	193	131169.....	182
124434.....	191	127129.....	193	131206.....	110, 111
124435.....	198	127130.....	189	131214.....	165
124451.....	189	127131.....	189	131215.....	165
124508.....	182	127145.....	210	131216.....	165
124575.....	32	127325.....	193	131229.....	111
124586.....	195	127326.....	193	131230.....	111
124594.....	28, 29, 207	127379.....	208	131236.....	192
124640.....	29	127512.....	209	131430.....	184
124726.....	198	127513.....	209	131466.....	184
124803.....	199	127514.....	209	131524.....	195
124813.....	198	127515.....	209	131525.....	195
124814.....	196	127518.....	188	131526.....	182
124820.....	198	127551.....	219	131817.....	193
124844.....	196	127553.....	222	131944.....	110
124845.....	198	127554.....	219	131945.....	111
124846.....	199	127555.....	222	132019.....	184
124885.....	198	127600.....	199	132089.....	27
124903.....	190	127780.....	14	132090.....	27
124905.....	192	127783.....	14	132091.....	27
124913.....	189	128006.....	209, 215	132092.....	27
124941.....	192	128051.....	111	132093.....	27
124961.....	199	128054.....	195	132095.....	40
124967.....	199	128139.....	125	132139.....	183
124968.....	190	128254.....	67, 74	132154.....	27
125214.....	196	128255.....	67, 74	132155.....	27
125215.....	196	128256.....	251	132163.....	27, 40
125222.....	186	128257.....	67, 74	132187.....	25, 41
125296.....	199	128268.....	219	132188.....	27
125297.....	198	128305.....	67	132440.....	190
125403.....	190	128442.....	200	132571.....	110
125494.....	198	128561.....	214, 215	132924.....	140
125548.....	185	128562.....	214	133090.....	214
125572.....	189	128563.....	216	133095.....	125
125643.....	192	128564.....	216	133281.....	211
125644.....	185	128565.....	216	133282.....	211
125660.....	190	128567.....	185	133457.....	41
125661.....	190	128568.....	185	133643.....	24, 185, 208
125662.....	190	128570.....	214	133644.....	185
125778.....	189	128571.....	214	133645.....	190
125779.....	198	128572.....	214, 216	133668.....	122
125781.....	198	128573.....	214, 216	133789.....	33, 34
125783.....	187	128579.....	214	133791.....	33, 34
125910.....	25, 41	128580.....	214	133804.....	245
125926.....	192	128581.....	216	133910.....	41
126070.....	232	128582.....	216	133919.....	40
126170.....	199	128679.....	214	133958.....	41
126243.....	199	128680.....	216	133960.....	41
126247.....	143	128682.....	216	133991.....	41
126248.....	143	128862.....	214	133994.....	40
126249.....	143	129031.....	55, 178	133995.....	40
126250.....	143	129133.....	198	134010.....	40
126251.....	143	129134.....	199	134011.....	40
126311.....	29	129535.....	183	134105.....	122
126327.....	191	129644.....	243, 247	134142.....	40
126329.....	191	129752.....	186, 244	134167.....	40
126330.....	191	129755.....	192, 243	134169.....	40
126331.....	165, 207	129759.....	243	134170.....	40
126366.....	198	129763.....	189	134178.....	38
126418.....	198	129764.....	184	134179.....	39
126431.....	193	129801.....	247	134180.....	39
126432.....	191	129872.....	193	134250.....	122
126562.....	199	130280.....	165	134337.....	122
126565.....	198	130281.....	216	134338.....	122
126961.....	193	130282.....	165	134339.....	122
126975.....	199	130283.....	165	134340.....	122
126976.....	190	130883.....	210	134341.....	122
126979.....	198	130938.....	211	134342.....	122
127012.....	209	130965.....	218	134343.....	122
127093.....	190	130966.....	218	134344.....	122
127099.....	186	130992.....	190	134354.....	122
127104.....	184	130993.....	189	134362.....	122
127119.....	196	130996.....	189	134363.....	122

INDEX

PART NO.	PAGE NO.	PART NO.	PAGE NO.	PART NO.	PAGE NO.
134364	122	185281	196	555888	210
134365	122	191892	182	556026	232
134366	122	192889	200	556327	136, 143, 149
134372	122	194048	182	556328	157
134373	122	200021	209	556371	132, 136, 149
134374	122	202965	187	556402	183
134375	122	206728	80	556403	183
134376	122	207123	197	556404	183
134393	122	208434	187	556405	183
134410	40	209029	197	556406	183
134411	40	215407	80	556407	185
150171	184	217430	187	556408	182
150286	184	222297	188	556410	186
150287	184	234412	167	556411	186
151519	182	239877	80	556416	184
155470	187	239887	80	556419	185
155494	187	241234	125	556420	24, 25, 185
155495	187	241485	80	556424	162, 186
155541	187	241486	80, 84, 85	556427	158, 186
155570	187	241572	80	556429	210
155653	187	241573	80	556448	210
155665	187	241623	80	556540	136, 143, 149
155677	188	243159	84	556567	138, 145, 151
155699	181	243170	84, 85	556568	139, 146, 150
155865	187	243191	85	556569	138, 145, 151, 159
156022	184	244023	85	556570	139, 146, 150
156172	187	247443	84	556572	160, 166
156173	187	247444	84	556586	245
156296	182	247450	84	556624	237
156580	184	247538	84, 85	556634	222
156589	188	247540	84	556636	223
156684	187	247574	84	556637	223
156823	24, 187, 208	247575	80, 84, 85	556638	221, 249
156849	182	247700	54, 85	556639	223
156971	182	247701	54, 85	556640	223
157191	182	247702	54, 85	556642	221
157350	182	247703	85	556643	223
157416	188	247704	85	556644	167, 221, 249
157676	188	247706	84, 85	556645	223
157705	187	247707	84, 85	556646	223
157785	187	247886	26, 248	556647	221
158212	183	247902	84, 85	556648	223
158256	187	258262	234	556656	223
158383	187	258263	234	556660	221, 245, 249
158491	182	258299	202	556661	221
158555	182	258348	251, 252	556665	245
158581	183	260067	28, 104, 175	556666	223
158586	183	261840	192	556762	189
158683	181	262205	199	556763	192
159153	187	262206	199	556764	192
159239	182	262208	199	556808	234
159801	188	262210	199	556812	237
159840	184	295607	186	556939	237
159841	183	297085	195	556944	237
159842	184	500352	196	556994	136
160022	187	502033	196	556997	157
160032	182	502820	195	557153	178
160327	187	502851	196	557154	178
160701	182	503086	195	557160	44
161037	187	503931	199	557161	44
161077	187	512351	196	557162	58
161889	188	512420	185	557207	61, 230
162024	183	516308	196	557208	230
162449	182	517434	196	557264	111
162505	187	551387	208	557270	45, 60, 230
162718	184	555406	157	557271	45, 60, 230
164259	181	555453	179, 180, 181, 182	557272	45
164815	185	555457	144, 196	557273	45
165198	182	555694	166	557278	208
166242	195	555726	222	557280	74
166590	181	555727	169	557286	47
166866	195	555728	169	557293	47
166999	181	555749	189	557349	131, 137, 186
175013	182	555808	186	557373	209

INDEX

PART NO.	PAGE NO.	PART NO.	PAGE NO.	PART NO.	PAGE NO.
557374	209	557811	177	558799	137, 186
557377	110	557813	49	558881	234
557391	153, 154, 158, 186	557814	49	558906	97, 209
557392	184, 249	557815	49	558910	185
557393	184, 249	557816	49	558938	166
557395	181, 219, 249	557817	49	558941	150
557402	78	557818	49	558949	49
557422	151, 173	557819	49	558950	49
557423	151, 173	557820	49	558951	49
557424	151	557821	47	558953	49
557425	151	557822	47	558954	49
557427	151	557824	235	558955	49
557428	151	557825	47, 73	558956	49
557429	151	557827	235	558968	166
557433	74, 78	557829	74, 207	559037	61, 230
557434	74	557864	74, 97, 98, 208	559307	93
557435	74	557866	74, 208	560381	58, 92, 93
557436	74	557874	209	560384	92
557437	74	557875	209	560387	92
557438	74	557880	209	560388	92
557439	74	557898	245	560389	92
557484	157	557901	245	560390	92
557488	154	557941	248	560392	92
557489	154	557943	111	560528	183
557490	154	557944	111, 209, 216	560530	181
557491	154	557945	111	560532	181
557492	154	557946	111	560533	181
557493	154	557950	223	560540	185
557494	154, 163	557954	181	560541	185
557508	136, 143, 149	557955	184	560542	185
557509	153	557963	223	560543	185
557514	131	557966	246	560576	154
557515	132	557968	210	560583	166
557516	132	557969	210	560591	163
557517	132	557997	49	560592	163
557518	132	557998	49	560593	163
557519	132	558021	166	560594	163
557520	132	558022	166	560595	163
557546	175	558024	166	560596	163
557551	73	558025	166	560597	163
557700	178	558031	109	560600	163
557701	178	558156	116	560601	163
557720	129	558159	116	560602	163
557721	136	558188	116	560603	163
557731	136, 149	558189	116	560604	163
557732	136, 149	558190	116	560605	163
557733	136, 149	558220	116	560620	154
557734	136, 149	558221	234	560643	131
557735	136, 149	558289	60, 230, 236	560645	131
557736	136, 149	558290	60, 230, 236	560701	78
557738	136, 149	558291	60, 230	560734	67
557739	136, 149	558292	60, 230	560919	136, 149
557740	136, 149	558293	60, 230	560920	139
557741	139, 146, 166	558294	60, 230	560936	136
557745	150, 166	558298	208	560943	136
557746	139, 146, 166	558306	117	561028	166
557747	166	558307	117	561029	157
557752	166	558308	117	561067	49
557766	157	558309	117	561101	133
557767	157	558310	117	561102	155, 160
557768	157	558311	117	561131	219
557769	157	558312	117	561132	223
557770	157	558313	117	561133	223
557771	157	558314	117	561134	223
557772	157	558315	117	561140	166
557774	160	558316	117	561370	92
557781	28, 73, 74, 104, 129, 175	558317	117	561430	185
557803	177	558318	117	562500	131
557804	177	558321	117	562501	131
557805	177	558322	117	562502	131
557806	177	558323	117	562503	131
557807	177	558633	143	562504	131
557808	177	558794	183	562505	131
557810	47	558795	185	562508	131

INDEX

PART NO.	PAGE NO.	PART NO.	PAGE NO.	PART NO.	PAGE NO.
562509	131	562723	137	562917	154
562510	131	562724	137	562925	234
562511	131	562725	137	562926	234
562514	153	562726	137	562927	234
562515	153	562727	137	562928	234
562516	153	562729	137	562929	234
562517	153	562730	137	562951	233
562518	153	562731	137	562952	234
562519	153	562732	137	562994	167, 169
562520	153	562733	137	562995	221
562521	153	562739	137	563005	93
562522	153	562740	137	563013	61, 93, 230
562523	153	562741	137	563014	69, 73
562524	153	562742	137	563015	44, 45, 69, 73, 90
562525	153	562743	137	563016	44, 45, 69, 73, 90
562526	153	562755	144	563020	234
562527	153	562756	144	563024	234
562538	153	562757	144	563030	237
562539	153	562758	144	563032	237
562540	153	562759	144	563041	237
562541	153	562760	144	563042	237
562542	153	562813	158	563043	237
562543	153	562814	158	563044	237
562545	153	562815	158	563046	203
562546	153	562816	158	563048	204
562570	162	562817	158	563052	203
562571	162	562818	158	563053	74
562572	162	562819	158	563054	202
562573	162	562820	158	563055	202
562574	162	562821	158	563056	74
562575	162	562822	158	563057	202
562576	162	562823	158	563058	206
562577	162	562824	158	563060	203
562578	162	562825	158	563061	203
562579	162	562826	158	563068	176
562580	162	562827	158	563069	176
562581	162	562828	158	563070	176
562582	162	562829	158	563072	78
562583	162	562830	158	563073	177
562584	162	562831	158	563074	140, 177
562585	162	562832	158	563075	176
562647	202	562833	158	563076	176
562649	202	562834	158	563077	176
562653	129	562854	78	563078	176
562654	129	562855	78	563079	176
562655	129	562872	109	563080	176
562656	129	562884	73, 98	563093	177
562657	129	562885	73	563095	177
562658	129	562886	73	563096	177
562659	129	562887	73	563097	177
562660	137	562888	73	563100	177
562679	150	562889	73	563101	232
562680	150	562890	73	563102	178
562681	150	562891	73	563103	178
562682	150	562892	44, 45, 69	563111	234
562683	150	562893	44, 45, 69	563113	233
562684	150	562895	45	563120	58
562685	150	562896	44, 45, 69	563121	58
562686	150	562897	44, 45	563122	58
562687	150	562898	45	563129	169
562688	150	562899	45	563146	180
562689	150	562901	73	563147	180
562690	150	562902	44, 73	563148	180
562711	137	562903	44, 73	563149	180
562712	137	562904	73	563150	180
562713	137	562905	73	563153	179
562714	137	562906	73	563154	179
562715	137	562907	69	563156	24, 155, 172
562716	137	562908	45	563157	24, 155, 172
562717	137	562909	73	563158	24, 155, 172
562718	137	562911	73	563159	24, 155, 172
562720	137	562914	132	563160	24, 97, 155, 172
562721	137	562915	132	563161	24, 155, 172
562722	137	562916	154	563162	172

INDEX

PART NO.	PAGE NO.	PART NO.	PAGE NO.	PART NO.	PAGE NO.
563163	133	563260	154, 160, 175	563506	238
563164	133, 172	563261	138, 151, 159	563507	178
563166	133, 172	563262	151	563508	178
563167	133, 172	563263	138, 151	563509	178
563168	172	563269	164, 175	563510	178
563169	172	563270	129, 175	563511	178
563170	138, 159, 172	563271	129, 175	563512	178
563171	138, 159, 172	563272	73, 76, 132, 139, 154, 160, 175	563515	178
563172	138, 159, 172	563273	132, 139, 154, 160, 175	563516	178
563173	138, 159, 172	563275	169	563518	157
563174	138, 159, 172	563276	169	563519	157
563175	138, 159, 172	563277	163	563520	157
563176	138, 159, 172	563278	163	563521	157
563178	184	563279	136, 149	563522	157
563179	43, 45, 74, 89, 174	563287	154	563524	158
563180	74	563304	71	563525	158
563182	174	563305	82	563526	158
563183	174	563306	71	563527	157
563184	43, 45, 89, 174	563307	82	563555	129
563185	174	563308	71	563557	49
563186	74, 174	563315	69, 74, 76	563558	47
563187	174	563316	44, 45, 73, 90	563565	235
563188	174	563317	44, 45, 73, 90	563566	235
563191	174	563318	73	563571	69
563192	174	563319	61, 73	563572	69
563193	174	563320	61, 73	563573	69
563194	174	563321	61, 73	563574	69
563195	201	563322	43, 45, 69, 73, 76, 89	563575	69
563196	201	563323	72	563576	69
563197	201	563324	72	563577	69
563198	201	563325	74	563578	69
563199	201	563326	74	563579	69
563200	201	563327	74	563580	98
563201	201	563328	74, 207	563589	251
563203	205	563329	72	563590	251
563206	201	563330	72	563593	251
563207	74, 201	563331	72	563625	251
563210	201	563332	69, 74, 76	563644	251, 252
563211	74, 201	563333	72	563645	251, 252
563212	179	563337	74	563646	251, 252
563213	179	563339	47	563647	252
563214	179	563358	76	563648	251, 252
563215	179	563364	76	563654	251, 252
563221	151, 173	563365	76	563655	251, 252
563222	151, 173	563380	44, 45	563706	251, 252
563223	173	563383	45, 90	563727	252
563224	151, 173	563384	43, 45, 89	563728	251, 252
563225	173	563385	43, 45, 89	563762	69
563226	151, 173	563386	45	563769	245
563228	173	563387	45	563770	111, 210
563229	151, 173	563388	45	563776	210, 221
563230	239	563389	45	563783	220
563231	133, 171	563393	97	563786	219
563232	133, 171	563421	136, 149	563788	220
563233	133, 171	563422	136	563789	220, 244
563234	133, 171	563424	136, 149	563796	220, 244
563235	133, 171	563425	136, 149	563814	251
563236	133, 171	563447	136	563854	251, 252
563237	171	563451	136	563856	252
563239	155, 171	563456	140	563857	252
563240	155, 171	563461	140	563858	251, 252
563241	155, 171	563465	139	563859	252
563242	155, 171	563469	137	563860	252
563243	155, 171	563470	137	563862	252
563244	155, 171	563471	137	563874	251
563245	155, 171	563472	137	563888	251
563251	139, 146, 150, 175	563476	154, 160, 166	563902	71
563252	138, 159, 171	563479	177	563903	71
563253	138, 159, 171	563480	177	563904	71
563254	138, 159, 171	563495	166	563905	82
563255	138, 159, 171	563502	238	563906	82
563256	138, 159, 171	563503	238	563909	76
563257	138, 159, 171	563504	238	563911	239
563258	138, 151, 159, 171	563505	238	563912	78

INDEX

PART NO.	PAGE NO.	PART NO.	PAGE NO.	PART NO.	PAGE NO.
563913	78	564350	179	2002244	36
563915	44	564351	179	2002247	36
563916	44	564355	173	2002248	36
563917	153, 157	564356	129, 175	2002258	36
563918	235	564357	132, 139, 154, 160, 175	2002295	26
563919	235	564377	43, 45, 89	2002296	26
563920	235	564399	154, 160, 166	2002702	36
563921	44	564402	164, 166	2003467	19, 41
563924	97	564406	178	2003896	19, 243, 247
563926	162	564411	49	2004436	15
563929	136	564412	47	2004439	15
563934	73	564413	47	2004441	15
563948	131	564414	47	2004443	15
563954	174	564415	47	2004445	15
563955	174	567251	137, 139, 150, 186	2004446	15
563956	174	571026	23	2004447	15
563957	174	571028	24	2004545	36
563959	174	571030	25	2004626	36
563960	174	571031	25	2004968	36
563961	174	571032	25	2006075	214
563962	43, 74, 78, 89, 174	571033	25	2006225	36
563963	74, 174	571036	25	2006597	14
563964	74, 174	571039	110	2006886	36
563965	43, 74, 89, 174	571040	110	2006887	36
563966	74, 174	571041	22, 23, 41	2007096	24, 25, 43, 45, 89, 208
563969	166	571058	24	2007333	56
563970	164, 166	571063	23	2008155	24, 208
563984	220	571064	26	2008337	20
563994	220	571070	24	2008771	219
564015	61, 93, 230	571071	24	2008943	30
564019	116	571155	23	2008944	30
564020	116	571156	23	2008945	30
564021	116	571157	23	2009010	194
564022	116	571158	23	2009011	194
564024	116	571159	25	2009432	56
564025	116	571162	26	2009845	56
564034	116	571167	26	2010555	56
564054	58	571172	30	2010651	28, 207
564055	58	571182	23	2010688	56
564058	61, 230	571255	25	2011184	56
564059	174	571286	22, 23, 41	2011185	56
564086	219	571287	22, 23	2011186	56
564090	220, 244	571288	22, 23	2011187	56
564151	233	571289	22, 23	2011787	32
564166	58, 92, 93	2000047	15	2012025	32
564167	58, 92, 93	2000200	14, 26	2012394	32
564168	92	2000534	15	2013442	211
564170	58, 92, 93	2000535	15	C19005	188
564171	92	2000536	15	C19466	184
564172	92	2000537	15	C19491	184
564173	92	2000538	15	C19660	183
564174	92	2000539	15	C19681	183
564178	92	2000634	14	C19685	183
564179	58, 92, 93	2000635	14	C20461	182
564182	92	2000636	14	C20465	182
564186	92	2000637	14	C20477	182
564194	252	2000638	14	C20485	182
564196	92	2000639	14	C20487	182
564200	164, 171	2000640	14	C20489	182
564276	234	2000641	14	C20490	182
564277	234	2000643	14	C20686	192
564278	234	2000644	14	C20694	192
564279	234	2000645	14	C20708	190
564280	234	2000646	14	C20768	190
564282	234	2000647	14	C38324	181
564283	234	2000648	14	LM1215	89
564290	92	2000649	14	LM4215	89
564318	43, 45, 89	2000650	14	LM5214	89
564322	73	2000651	14	LM6214	89
564332	232	2001401	30	LM6334	43
564336	233, 234	2001714	19	LM6544	43
564342	177	2002240	36	LM6611	43
564343	177	2002241	36	LM7214	89
564349	179	2002243	36	LM7534	43

INDEX

PART NO.	PAGE NO.	PART NO.	PAGE NO.	PART NO.	PAGE NO.
LM8114	89	MBJ0AM	58, 228		
LM8534	43	MBJ0AN	228		
LM9521	43	MBK0AK	58, 228		
MBA0AA	92, 228	MBK0AL	58, 228		
MBA0AB	92, 228	MBK0AM	58, 228		
MBA0AC	92, 228	MBK0AN	58, 228		
MBA0AD	92, 228	MBL0AK	58, 228		
MBA0AE	92, 228	MBL0AL	58, 228		
MBA0AF	92, 228	MBL0AM	58, 228		
MBA0AG	92, 228	MBL0AN	58, 228		
MBA0AH	92, 228	MBM0AK	58, 228		
MBA0AJ	93, 228	MBM0AL	58, 228		
MBA0AK	93, 228	MBM0AM	58, 228		
MBA0AL	93, 228	MBM0AN	58, 228		
MBA0AM	93, 228	MBN0AK	58, 228		
MBA0AN	93, 228	MBN0AL	58, 228		
MBB0AA	92, 228	MBN0AM	58, 228		
MBB0AB	92, 228	MBN0AN	58, 228		
MBB0AC	92, 228	MBP0AY	58, 228		
MBB0AD	92, 228	MBR0AY	58, 228		
MBB0AE	92, 228	MBS0AY	58, 228		
MBB0AF	92, 228	MM1112	47		
MBB0AG	92, 228	MM1113	47		
MBB0AH	92, 228	MM1212	47		
MBB0AJ	93, 228	MM1412	47		
MBB0AK	93, 228	MM2112	47		
MBB0AL	93, 228	MM2212	47		
MBB0AM	93, 228	MM2412	47		
MBB0AN	93, 228	MM3212	47		
MBC0AA	92, 228	MM3412	47		
MBC0AB	92	U70015	185		
MBC0AC	92	U70234	195		
MBC0AD	92	U70588	198		
MBC0AE	92, 228	U70933	199		
MBC0AF	92				
MBC0AG	92				
MBC0AH	92				
MBC0AJ	93, 228				
MBC0AK	93, 228				
MBC0AL	93, 228				
MBC0AM	93, 228				
MBC0AN	93, 228				
MBD0AA	92, 228				
MBD0AB	92				
MBD0AE	92, 228				
MBD0AF	92				
MBD0AJ	93, 228				
MBD0AK	93, 228				
MBD0AL	93, 228				
MBD0AM	93, 228				
MBD0AN	93, 228				
MBE0AA	92, 228				
MBE0AB	92				
MBE0AE	92, 228				
MBE0AF	92				
MBE0AJ	93, 228				
MBE0AK	93, 228				
MBE0AL	93, 228				
MBE0AM	93, 228				
MBE0AN	93, 228				
MBFOAA	92, 228				
MBFOAB	92				
MBFOAE	92, 228				
MBFOAF	92				
MBGOAA	92, 228				
MBGOAB	92				
MBGOAE	92, 228				
MBGOAF	92				
MBH0AA	92, 228				
MBH0AB	92				
MBH0AE	92, 228				
MBH0AF	92				
MBJ0AK	58, 228				
MBJ0AL	58, 228				



MOVING MATERIALS THAT MATTER™

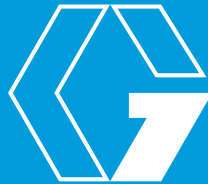

For more information visit [graco.com](https://www.graco.com)

©2026 Graco Inc. 340821 EN - AR. 2/26 All written and visual data contained in this document are based on the latest product information available at the time of publication. Graco reserves the right to make changes at any time without notice. Trademarks are referenced herein for identification purposes only. All trademarks are the property of their respective owners. Product covered by issued and pending patents, see [graco.com/patents](https://www.graco.com/patents).